



# FLAGGER TRAINING MANUAL



June 2012

## **INSTRUCTIONS**

This manual is for self-training. Everyone working as a flagger on Colorado Highway projects will have studied this document and successfully taken the required examination.

It is a necessary requirement that all flaggers be able to read and understand the "Flagger Training Manual," the "Flagger Reference Guide," and the Flagger Proficiency Exam in order to complete the Department's minimum training requirements and become a certified flagger

Arrangements should be made with an approved proctor in one of the Region Offices of the Colorado Department of Transportation (CDOT) or an approved proctor in the private sector for administering the examination. All persons who have successfully completed the training will be issued a flagger certification card that will be good for two years.

People who did not successfully complete the training course may be given the opportunity to restudy the Manual and take another examination.

All persons taking this exam must be at least 18 years of age.

# TABLE OF CONTENTS

<b>Traffic Safety and You</b>	1
<b>Section A</b> Where Do I Fit In	2
<b>Section B</b> People and Signs	7
<b>Section C</b> Traffic Control Devices - Channelizers	15
<b>Section D</b> Tools of the Trade	21
<b>Section E</b> Dressing for the Job	24
<b>Section F</b> Your Job Duties	28
<b>Section G</b> How to Flag	35
<b>Conclusion</b>	41

This "Flagger Training Manual" supersedes the manual dated September 2005.

# TRAFFIC SAFETY AND YOU

## Your Role

Road construction and maintenance projects are being performed each day across the state of Colorado. **As a flagger, you will play a vital role in helping to protect the traveling public as well as your co-workers from the dangers and hazards that are present in highway and road construction projects.** Your job is crucial--the safety of the public and the construction or maintenance crew may very well lie in your hands. Why?

## Your Respon- sibility

As you may know, most road and highway construction and maintenance jobs are performed while traffic is allowed to pass through the work areas. Thus, heavy equipment, road obstacles, unfinished or rough pavement and other hazards may exist. These hazards present real dangers to the traveling public that is passing through the area. In addition, the crew working on the roadway needs to be protected from the traffic. It is the flaggers responsibility to see that traffic moves safely and efficiently through the construction areas. **It is also your responsibility to protect the construction crew from the hazards presented by traffic.**

You can see that the job of a flagger is extremely important. In order to do this job efficiently and well, you must be **CERTIFIED**. But how do you get certified? How will you learn your job?

## HOW THIS MANUAL CAN HELP

This manual will help you learn about the job of a flagger. It tells you WHAT your JOB is, HOW you will PERFORM the job duties, WHAT you WEAR, and HOW you FIT into the overall temporary traffic control system. In addition, you will read about the different traffic control devices with which you need to be familiar to perform your job. Thus, it is very important that you read this material carefully. You will also find that there have been specially designed review exercises inserted into the manual which will help you remember what you have read. So, if you read this material carefully, you will have a good background to begin your important work as a flagger.

## Testing Your Knowledge

Once you have studied this manual, **you will be given a proficiency test by the Colorado Department of Transportation.** This test will measure your knowledge and understanding of the duties and responsibilities of flaggers. If you get a passing score (80%) on the test, you will be given a card which indicates that you have had some training and have passed the proficiency test. You will then be ready to begin your actual on-the-job work as a flagger. You may be asking, "Where do flaggers fit into a construction project?" "When are flaggers needed?" Next, you will learn when flaggers are needed, and how they fit into the construction project.

# **SECTION A**

## **WHERE DO I FIT IN?**

### **When Flaggers Are Needed**

There are flaggers needed on all sorts of road construction and maintenance jobs across the state of Colorado. **In general, flaggers are needed whenever the safety of the construction crew or the motoring public is a question. Safety questions arise whenever a traffic lane is going to be blocked, whenever an area is congested and construction equipment is going to be moved in or out of this area and for many other reasons.** Thus, flaggers are used to keep traffic moving smoothly and safely and to protect the crew members.

As a flagger, you may be working for construction companies--contractors who have submitted bids for and been retained to perform various road construction and maintenance projects. In addition, flaggers are usually needed for some projects run by public utilities, such as the telephone company or the gas company. All of these various jobs will require the same standards of professionalism from flaggers. And, usually, the requirements, duties and responsibilities in working for these various organizations will be the same. Therefore, the material you read in this manual will be applicable to any flagger job you get. However this is not to say that all construction jobs will be the same. They will not be. Each job will have DIFFERENT demands and perhaps DIFFERENT duties. However, the overall responsibilities of a flagger will remain the same. But before you read about your various responsibilities and duties, you will need to know where you will fit in on a construction team--for a contractor or a public utility or a city/county authority . Let's discuss each of these separately.

### **WORKING FOR A CONTRACTOR:**

As you have read, contractors bid for and receive many of the contracts for road construction projects in Colorado. However, once a contractor gets a job or contract, he must work very closely with the Colorado Department of Transportation so that all specifications for the work are met.

### **How the Crew is Organized**

**Each project will have a SUPERINTENDENT--an employee of the contractor. This person is responsible for the entire construction project. There will also be a FOREMAN who is responsible for the day-to-day operations on the project, such as directing the construction workers who actually perform the work on the project.** In many cases, the foreman will also be responsible for all of the safety measures that are needed on a project. Or , he may assign another experienced person to handle the traffic safety aspect. The person who is responsible for the safety measures may be called the TRAFFIC CONTROL SUPERVISOR. You will be responsible to that person, as well as to the foreman of the project.

The traffic control supervisor and/or the foreman will help you with your job--and be responsible for monitoring and evaluating your performance. These people will have the authority to remove you from the job if you are not performing up to standards.

### **Where the Colorado Department of Transportation (CDOT) Fits in**

In addition to the contractor's crew, there will be two members from the CDOT who are assigned to the construction project. These two people are the PROJECT ENGINEER and the RESIDENT ENGINEER. **The project engineer will handle all of the engineering aspects of the project--making sure specifications are met and handling the quality control side of the project.** The project engineer is also responsible for monitoring the TRAFFIC CONTROL and SAFETY MEASURES that are taken on the project, to make sure that they are adequate and meet state specifications. **The resident engineer will visit the project often and serve as the overall coordinator.** He will handle any problems which may arise at the work site or with the construction company.

The project engineer and the resident engineer have a great interest in the kind of job you will be doing as a flagger. Although you will technically be working for the contractor, you will find that the project engineer and resident engineer may also evaluate your performance on the job and if you are not doing your job correctly or meeting the safety standards

which are outlined for the project, either of the engineers may take steps with the contractor and/or the traffic control supervisor to have you dismissed from your job.

Although it sounds as if you will have many bosses, this is not true. You must remember that traffic control and safety is very important and that there must be coordination between the contractor and the CDOT

### **Working for a Public Utility:**

Public utility companies have many kinds of projects which can interrupt and confuse traffic situations. For example, you have probably seen flaggers hold traffic back or re-route traffic around areas where the telephone company is working on street-side projects. Or, perhaps you have seen a detour around utility trucks when work is being done on water mains under the street.

Although the public utility companies do not perform road construction and maintenance projects, they often need flaggers to help move traffic around areas where they are working on other types of projects. **These crews are set up very much like the crews you have read about before. There will, in most cases, be a foreman who is responsible for the project and for overseeing the crew.** If you happen to get a job as a flagger on one of these projects, you will report to the foreman. He will most often be responsible for the safety measures on the project. Thus, you will follow his directions and instructions in performing your job.

### **How the Crew is Organized**

**WORKING FOR A CITY OR COUNTY ROAD DEPARTMENT:** City/county construction crews will be set up very much like the public utilities.

Regardless of whom you work for--a contractor, public utility or the city or county your basic responsibilities and qualifications as a flagger will remain the same. You have read earlier about these responsibilities but let's look at them again, in more detail.

### **YOUR BASIC QUALIFICATIONS**

It is the EMPLOYER'S RESPONSIBILITY to ensure that the flagger meets the minimum qualifications as outlined in the Manual on Uniform Traffic Control Devices (MUTCD).

### **YOUR BASIC RESPONSIBILITIES**

You read earlier how important traffic safety is on a construction or maintenance job. But what are your basic responsibilities?

You will be responsible for:

--PROTECTING yourself and your co-workers from traffic that is passing through or around a road construction or maintenance site

--PROTECTING the traveling public from construction dangers that are present on the construction site

--GUIDING traffic efficiently through or around a construction site

--USING your skills and intelligence in all flagging situations

Let's look at each of these responsibilities separately.

### **PROTECTING YOURSELF AND YOUR CO-WORKERS**

You and your co-workers on the construction team have very important tasks to perform.

### **Helping Your Co-Workers**

And, all of these tasks involve exposing yourselves to the dangers on the construction site and the dangers from the traveling public. **You must be able to perform your job in such a manner as to keep yourself and these people safe so that you may do your jobs without interruption and with minimal danger.** Thus, you must always be alert to any dangers that may be present.

For example: Suppose you are flagging on a construction site on a highway where there are a lot of cars, traveling at fairly high speeds. Your co-workers are working on the road surface--exposed to cars that are traveling through or near the site. You must be able to route all cars, trucks and other vehicles around the work site so the construction workers can operate in safety. You are responsible for your safety.

## PROTECTING THE PUBLIC

### Protecting the Public

**As you know, you must protect the traveling public from the road construction work area. To do this, you may need to stop and hold traffic until it is safe to pass or slow traffic down and alert the drivers to the dangers ahead.** For example: Perhaps large and heavily loaded construction vehicles are attempting to move from a haul road onto the highway. You may have to stop traffic long enough for these trucks or vehicles to pass safely onto the highway. By doing this, you are avoiding potential collisions between motorists and the construction vehicles. Or, perhaps road construction crews are replacing a section of highway and traffic must be routed around the hazardous area. You may be responsible for slowing traffic down and alerting the drivers to the dangers ahead.

## GUIDING TRAFFIC EFFICIENTLY

### How Flaggers Can Help

Because road construction and maintenance projects do present hazards to the motoring public, flaggers are needed to keep traffic moving smoothly and efficiently through or around construction sites. For example: Perhaps construction work is being done on a two-lane roadway, where traffic normally proceeds in two directions. And, perhaps the construction work involves closing one of the two lanes of traffic. If traffic is going in two directions, but there is only one lane, a major problem arises. Who gets to go first? How can head-on collisions be avoided? This is a problem that flaggers will be able to help solve. **Flaggers will be needed to help regulate the traffic flow so that the motorists can pass smoothly, easily and safely.**

## USING YOUR SKILLS AND INTELLIGENCE

### When Problems Arise

Although you will normally be supervised by the person in charge of traffic control and safety, there will be many instances where you will have to think QUICKLY and use your own judgment. **Perhaps you are diverting cars around a construction site near the side of a mountain where there is the possibility of rocks and debris being jarred loose and sliding onto the road surface.** And, perhaps a boulder or landslide begins to crash across the roadway. Your instructions from the traffic control supervisor or foreman were to keep the traffic moving slowly through the site. However, because of the landslide you will have to take the responsibility for stopping the traffic yourself and alerting the foreman or Traffic Control Supervisor of the danger.

Let's take another example. Perhaps you are flagging in an area where there are high winds, and perhaps the advance warning sign which lets approaching traffic know that there is a flagger on duty, has blown over. Without the advance signs, traffic will not be alerted to the dangers ahead, and a serious accident could occur. YOU will be responsible for ALERTING the traffic control supervisor that the sign is down. You may have to take extra precautions with the oncoming traffic to avoid accidents or problems. However, you should **NOT LEAVE YOUR FLAG STATION TO ATTEND TO THIS PROBLEM.**

### Use Your Judgement

There is one other item for which you will be responsible--yourself. **You must make sure you PROTECT not only the public and your co-workers, but also YOURSELF. Because you are constantly exposed to dangers from road construction, as well as from erratic or careless drivers, you must constantly be on guard to protect your-**

**self.** Of course, there are many things that you can do to ensure your own safety, such as wearing the proper high visibility clothing, using the correct methods and procedures for flagging.

**Ensuring  
Your Safety**

**You must also always check your flagging station to make sure that you have an escape route if you become exposed to danger.** For example, perhaps you are at a flag station fairly close to some heavy construction machinery. You must be on guard constantly so that you don't get in the way of the heavy machinery. Similarly, if you are directing traffic and find a heavily loaded truck or careless driver will be unable to stop before hitting you, make sure you have a safe escape route. In other words, if you are flagging on a bridge and become exposed to danger and your only alternative is to jump off the bridge, you will realize your flagging station was in the wrong location. Thus, be aware that you must always protect yourself as well as the public and your co-workers. ALWAYS have an "OUT" or an escape route, to be used in times of extreme danger

**Have an  
"Out"**

In the next part of this manual, you will read about your job in more detail--about the people who can help you perform your duties and the standard equipment with which you should be familiar. However, before you read any further complete the following exercise--it will help you remember what you have read in this section. Once you have completed the exercise, check your answers. If you have missed any of the questions, reread the material involved. Then proceed with the next part of this manual.

**TRAFFIC SAFETY AND YOU--EXERCISE A:**

(Please record your answers on a separate sheet of paper. Answers are on next page.)

- 1) You are responsible for which of the following items of a construction site:
  - a) The safety of your co-workers
  - b) The safety of the traveling public
  - c) Good traffic control
  - d) Your own safety
  - e) All of the above
- 2) True or false? Traffic safety at a construction site is very important.
- 3) True or false? You may be working as a flagger for either a contractor or a public utility company.
- 4) True or false? Although there are specific and technical duties that you will be assigned, you will also have to use your own judgment in many situations.
- 5) True or false? An engineer who is working on a construction site for a private company may be involved in traffic safety.
- 6) True or false? The resident engineer will be on the job at the site each day and will participate in all phases of traffic control.
- 7) True or false? In order to become a flagger, you will need to pass a written test.
- 8) True or false? Although there will generally be a foreman on the job and/or a traffic control supervisor, you will not report to any of these people. Instead, you will make all decisions and assign yourself all of the duties you will be performing.
- 9) True or false? You are responsible for seeing that traffic moves smoothly and in a timely fashion through a construction project.
- 10) True or false? You will have to use your skills and intelligence each day in your job.



## TRAFFIC SAFETY AND YOU--ANSWERS TO EXERCISE A:

- 1) e
- 2) True
- 3) True
- 4) True
- 5) True
- 6) False. The resident engineer, who is a staff member from CDOT is responsible for spot-checking construction sites for safety and handling any problems which may arise on the site.
- 7) True
- 8) False. You will be assigned to a supervisor when you report to the job. You will follow his or her directions completely.
- 9) True
- 10) True

# **SECTION B**

## **PEOPLE AND SIGNS**

In this section, you will learn about the specific details of your job. For example, you will learn about the people who can help you with your job, and signs with which you must be familiar.

Let's look at the people who can help you on your job, and the kinds of help you should expect to have.

### **PEOPLE WHO CAN HELP**

You will find that there are many people on the construction crew who will be able to help you on the job. Basically, the person who can help you the most will be the individual who has been assigned to handle all of the traffic control and safety measures. As you already have read, this person is usually called the traffic control supervisor (TCS). However, you should be aware that this may not be a full-time job except on very large construction projects. Thus, the foreman may be in charge of traffic control, or this job may be held by an experienced member of the work crew. In addition, there may be other members of the construction team who can help you.

What kind of help should you expect? **You should expect to be given clear directions--where to stand to flag, the kinds of signs and devices to use, and information and instructions regarding the traffic situation. You should also expect help in certain kinds of situations.** For example, perhaps some warning signs have blown over or have become too dirty to read. You should be able to request and get these signs replaced or repaired. **And, you should be able to request help when a safety situation becomes critical and backup flaggers or advance flaggers become necessary.** In these cases, although it will not be your decision as to whether or not to use extra flaggers, you should alert whoever is in charge so that the situation can be evaluated and handled.

**Help You  
Can  
Expect**

**Finally, you should expect to get help from your fellow crew members and supervisors if you have questions.** It's much better to ask questions when you are unsure of a situation, than it is to perform your duties when you are not certain what you should be doing. So, when you have a question--ask it! Your supervisors expect you to have many questions as you learn your duties and they are prepared to answer your questions. Remember, one of the ways you learn to be a good flagger is to use your skills and intelligence--and to ask questions. Make sure you KNOW what you are doing--DO NOT GUESS. The safety and lives of many people are involved.

**Always  
Ask  
Questions**

### **SIGNS YOU SHOULD KNOW ABOUT**

Basically, there are three types of signs-- REGULATORY, WARNING and GUIDE signs. And, each type of sign has a different purpose and function. Each category of signs has a certain color and shape scheme so they can be easily recognized. Highway construction and maintenance signs fall into these three categories. However, for warning and guide signs the background color is generally changed to orange rather than the standard color of yellow or green. Let's look at these different types of signs separately, beginning with the regulatory signs.

#### **REGULATORY SIGNS:**

**Regulatory signs impose legal obligations and/or restrictions on ALL traffic.** And, their use is always authorized by the official or public body that has jurisdiction over the road. What kinds of signs are regulatory signs? For example, speed limit signs are regulatory, as are "STOP" signs, "DO NOT ENTER" signs and "ONE WAY" signs. Most regulatory signs are rectangular in shape and carry a BLACK legend on a WHITE surface with BLACK BORDERS. However, not all regulatory signs are black on white. Let's take the example of the "STOP" sign. "STOP" signs are OCTAGONAL, and have WHITE letters on a RED back-

**Uses**

**Shapes  
and  
Sizes**



R1-1



R1-3P



R1-2



R1-2aP



R1-10P



R5-1



R5-1a



R5-2 \*



R5-3



R5-4



R5-5



R5-6



R5-7



R5-8



R5-10a



R5-10b



R5-10c



R5-11



R9-3



R9-13



R9-14



R2-1



R2-2P



R2-3P



R2-4P



R2-4a



R2-5P



R2-5aP



R2-5bP



R2-5cP



R2-6P



R2-6aP



R2-6bP



R2-10

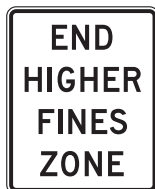

R2-11



R10-18



R10-19P



R10-19aP

## COMMONLY USED REGULATORY SIGNS

ground. And, "YIELD" signs are WHITE inverted TRIANGLES with RED LETTERS and a RED BORDER.

Sometimes on a road construction project, the normal regulatory signs such as speed limit signs may need to be removed or covered. For example, a regulatory sign on a highway may set the speed limit for that section of road to be 55 miles per hour. However, if construction requires that the traffic will have to slow down to 40 miles per hour in order to pass, then, a duly authorized person may cover the regular 55 mile per hour sign, with one which changes the speed limit to 40 miles per hour. **YOU SHOULD BE FAMILIAR WITH THE REGULATORY SIGNS AS THEY DO CARRY THE FULL WEIGHT OF THE LAW.**

**WARNING SIGNS:**

**Uses**

**Warning signs are used for construction and maintenance projects to notify drivers of dangers or hazards which may be present.** As you know, when construction is being done, the width of the pavement may be reduced, or perhaps there may be an open hole or obstructions on the roadway. The motoring public as well as pedestrians must be notified of these hazards so they do not become involved in an accident. Thus, WARNING SIGNS are used. Warning signs are generally (but not always) DIAMOND SHAPED and carry a BLACK legend and BORDER on an ORANGE background.



**Cover  
Unused  
Signs**

Let's look at some warning signs? You may have already seen such warning signs as "Flagger Symbol," or "DETOUR AHEAD," or even "ROAD WORK AHEAD". You will be involved quite a bit with some of these signs and you should understand and recognize warning signs and their uses. However, the individual in charge of the traffic control and safety will be responsible for deciding upon the USAGE and POSITIONING of these signs.

**FLAGGER SIGN (W20-7):** This sign is always placed in advance of any point where a flagger is going to be stationed. The number (W20-7a) serves as the sign's identifier. **The sign itself alerts motorists to the flagger's presence and gives them an adequate amount of time to begin to slow down.** The "Flagger" sign may be used in conjunction with other road construction signs such as "ROAD WORK AHEAD" signs. One important item: If there is NO Flagger on duty the sign SHALL be removed, covered, or turned away from traffic. This will help keep the motorists from becoming confused.

**BE PREPARED TO STOP (W3-4):** This sign may be used whenever there is a flagger on duty.

Although you will not usually be responsible for choosing your flag position or for positioning signs, you should know about using these two signs. If the "BE PREPARED TO STOP" sign is used, it should be placed between the "Flagger" sign and the flagger. The "BE PREPARED TO STOP" sign should always be placed far enough ahead of the flagger to allow adequate stopping distance.

**ADVANCE ROAD (STREET) WORK SIGN (W20-1) with an ahead or distance message:** **This sign is always placed in advance of any road or street work activity. It serves to warn oncoming motorists that there may be obstructions on the road ahead.** This sign may be used along with other signs, such as "Flagger" or "DETOUR AHEAD".

**DETOUR SIGN (W20-2):** **Detour signs should be placed in advance of any road section that has been closed or blocked, where an alternate route has been established.** If an alternate route is established, you should try to familiarize yourself with the route so that you can answer any questions that drivers may ask. You should know HOW LONG the detour will take to travel and WHERE IT LEADS. If you have this information, you may be able to keep motorists who are unfamiliar with the area from becoming lost or confused.

**ROAD (STREET) CLOSED (W20-3):** Many times you will find roadways being entirely closed to traffic so that the construction crews can get the road work done. **Generally, when a route is closed, an alternate or detour route will be set up.** Again, if this is the case, be sure that you have information about the detour so you can answer any questions.

**ONE LANE ROAD SIGN (W20-4)** **This sign is frequently used to pinpoint areas where traffic traveling in both directions must use a single lane.** Traffic is moved through the area in one direction at a time. Pilot cars, convoy systems, double flaggers an AFAD device, or temporary traffic signals can be used to handle the situation. You will read more about pilot cars and convoy systems later.

**ONE LANE BRIDGE SIGN (W5-3)** **This sign is frequently used to pinpoint areas where traffic traveling in both directions must use a single lane on a bridge.** Traffic is moved through the area in one direction at a time. Pilot cars, convoy systems, double flaggers, or temporary traffic signals can be used to handle the situation. You will read more about pilot cars and convoy systems later.



W20-7



W3-4



W20-1



W20-2



W20-3



W20-4



W5-3



W20-5

**LANE CLOSED SIGN (W20-5):** As you know, there are times when one, or several lanes of a multi-lane roadway may be closed due to construction. This sign is used in conjunction with other signs or traffic control devices to help channelize all traffic into open lanes, so that traffic may move safely and smoothly through a work area. This sign, as with any others that announce construction work ahead or lanes closed ahead may have specific footage carried on the legend of the sign, such as "AHEAD", "1000 FT" or "1 MILE".



W6-3

**TWO-WAY TRAFFIC (W6-3):** This sign lets drivers know that they are on a two-way undivided highway where traffic will be coming from the opposite direction.



W21-1

**WORKER SIGN (W21-1):** As you may work on jobs that involve minor maintenance or public utility work, you should be familiar with this sign. This sign is used at limited construction sites for the protection of the people who are involved in handling the job.



W22-1

**BLASTING ZONE SIGN (W22-1):** You may find that road construction, especially when new roadways are being created, will involve some use of explosives. Obviously, this is a potentially dangerous situation for both the traveling public and the work crew. Thus, whenever blasting is being done, appropriate blasting warning signs be used. Often, there will be a distance notation on the sign, so that motorists will know ahead of time where the blasting is occurring.

In addition, there are two other warning signs which shall be used along with the "Blasting Ahead" sign. They are: the "Turn Off 2-Way Radio (W22-2), and "End Blasting Zone (W22-3)." The "TURN OFF 2-WAY RADIO" sign is used so that motorists who have radios with a certain frequency level will not be able to set off the radio-activated explosives. The "END BLASTING ZONE" is used to tell drivers that they have cleared the danger zone and that they may resume using 2-way radios. Usually, the "TURN OFF 2-WAY RADIO" will be set at least 1,000 feet ahead, which will give the motorist adequate warning. The "END BLASTING ZONE" will be set at least 1,000 feet after the blasting zone. Again, the purpose of these signs is to alert and warn motorists that they are entering or leaving a zone where explosives are being used.



W22-3



W22-2



W13-1P

**ADVISORY SPEED PLATE (W13-1P):** Advisory speed signs may be used to indicate a recommended speed through a TTC (Temporary Traffic Control) area. Again, these warning signs will be orange and carry a black legend. The Advisory Speed plaque shall not be used in conjunction with any sign other than a warning sign, nor shall it be used alone. When used with orange TTC zone signs, this plaque shall have a black legend and border on an orange background. The sign shall be at least 24 x 24 inches in size when used with a sign that is 36 x 36 inches or large. Except in emergencies, an Advisory Speed plaque shall not be mounted until the recommended speed is determined by the highway agency.

There are many warning signs that are used in construction zones--and obviously not all of them can be explained here. However, you have read about some of the major signs which you will see often in your work.

### GUIDE SIGNS:

Guide signs are INFORMATION signs--that is, they give the motorist information which may be needed to pass through construction zones safely. Many guide signs used in construction work are ORANGE with BLACK letters and a BLACK border. These signs may give SPECIAL INFORMATION relating to the work being performed. In addition, there are guide signs which show directions and route markings. Let's look at some of these signs now.



G20-1



G20-2



G20-4

**LENGTH OF WORK SIGN (G20-1):** The "Length of Work" sign is very important, as it lets the motorist know the distance or section of road affected by the work. For example, the "ROAD WORK NEXT 5 MILES" alerts the motorist that road construction will be performed for the next 5 miles. That way they can slow down and be prepared for rough road, delays or heavy equipment. These signs are normally set up at the limits of any job which covers more than about 2 miles of road.

**END ROAD WORK (ROAD WORK) SIGN (G20-2):** You will nearly always find this sign at the end of a work or maintenance zone. It tells the motorist that he has passed through the affected area and may resume his normal driving habits. Thus, this sign is not only for safety purposes, it keeps the motoring public from becoming confused or frustrated.

**PILOT CAR SIGN (G20-4):** Often in construction sites, traffic will only be allowed to travel in one direction at a time. Or construction on the road may make passing through the site without guidance very difficult. In these cases, "Pilot Car" signs may be used, mounted clearly on the back of a car or truck, to help the traffic proceed through a work area. The sign may carry the legend "PILOT CAR--FOLLOW ME." Usually flaggers are needed to keep traffic stopped in both directions until a pilot car is available to guide the traffic through the area.

Let's look at an example. Perhaps construction is being done on one lane of a two-lane road, thus, closing off one lane to traffic. In addition, there are obstacles on the road surface--heavy machinery, boulders. Because traffic cannot proceed in two directions on one lane, a pilot car is necessary to guide the traffic in one direction while traffic in the other direction is stopped. You may be stationed at one end of the project, keeping traffic stopped, until the pilot car can guide traffic safely through the area to your side. Then, the pilot car will turn around and take your traffic and guide it the other way. Thus, pilot cars can be a very effective safe way to keep traffic flowing smoothly through a dangerous area, or when only one lane is open to both directions of traffic.



M4-9



M4-10

**DETOUR (M4-9) and DETOUR ARROW (M4-10) SIGNS:** Sometimes the normal route will be closed to traffic and a detour or alternate route may be established. These "DETOUR" and "DETOUR ARROW" signs are used to point the way to the alternate route. Most often, "DETOUR ARROW" signs are mounted near or just below a "ROAD CLOSED" sign.

You have now read about the three types of signs that you may be seeing in your work. Before you read any further, complete the following exercise. Then we'll discuss some of the other traffic control devices that you will need to know about in order to perform your job well.

### **PEOPLE AND SIGNS--EXERCISE B:**

(Please record your answers on a separate sheet of paper. Answers are on next page.)

- 1) Regulatory signs generally:
  - a) Impose legal obligations or restrictions on all traffic
  - b) Are orange with white letters
  - c) Are orange with black letters
  
- 2) A red octagonal "Stop" sign is what kind of sign?
  - a) A warning sign
  - b) An advisory sign
  - c) A regulatory sign
  
- 3) True or false? Warning signs are generally used to notify drivers of hazards which may be encountered on construction or maintenance projects.
  
- 4) What three signs shall be used around a construction area where blasting is being done?
  - a) "DETOUR 500 FT"
  - b) "BLASTING ZONE AHEAD"
  - c) "TURN OFF 2-WAY RADIOS AND CELL PHONES"
  - d) "END BLASTING ZONE"
  - e) "FRESH OIL"
  
- 5) The " \_\_\_\_\_ " sign is used in advance of shoulder maintenance.
  
- 6) True or false? If "DETOUR AHEAD" signs are being used, you should be able to give motorists instructions for the alternate route if necessary.



**PEOPLE AND SIGNS--ANSWERS TO EXERCISE B:**

- 1) a
- 2) c
- 3) True
- 4) b, c, d
- 5) "Shoulder Work"
- 6) True

# SECTION C

## TRAFFIC CONTROL DEVICES - CHANNELIZERS

There are many other types of traffic control devices used in highway and roadway construction operations. In this manual, we'll look at some of these devices--such as cones, barrels (drums) and barricades. However, before you continue you should understand that the actual USAGE and POSITIONING of these devices will be the responsibility of the traffic control supervisor or other authorized persons. You will not generally be responsible for setting and positioning these devices but you should be familiar with these devices, and know how and when they are used. In addition, you may be asked by the traffic control supervisor, to ASSIST in either the setup or take-down of the various devices. You will receive explicit directions as to the tasks you will perform in either setup or take-down procedures.

### CONES, TUBULAR MARKERS AND VERTICAL PANELS:

#### How Cones Are Used

As you have probably noticed, cones are the most frequently used traffic control device. And, this is true for a number of reasons. Cones are lightweight (made of plastic), which makes them very easy to use and move. In addition, the cones will do minimal, if any damage, if struck by a moving vehicle. **And, because the cones are always a BRIGHT ORANGE, they are extremely visible to the public. Cones used for traffic control are at least 18 inches tall, although larger ones, 22 inches or taller are required on expressways or freeways and where speeds are in excess of 45 mph, and during hours of darkness where visibility may be a problem.** It is important to note that the cones should always be kept clean and bright so that they can continue to be effective. The traffic control supervisor may ask you to help keep cones bright and clear, as a minimum you should notify him/her if they become damaged or dirty. For nighttime use, cones shall be retroreflective or equipped with lighting devices for maximum visibility.

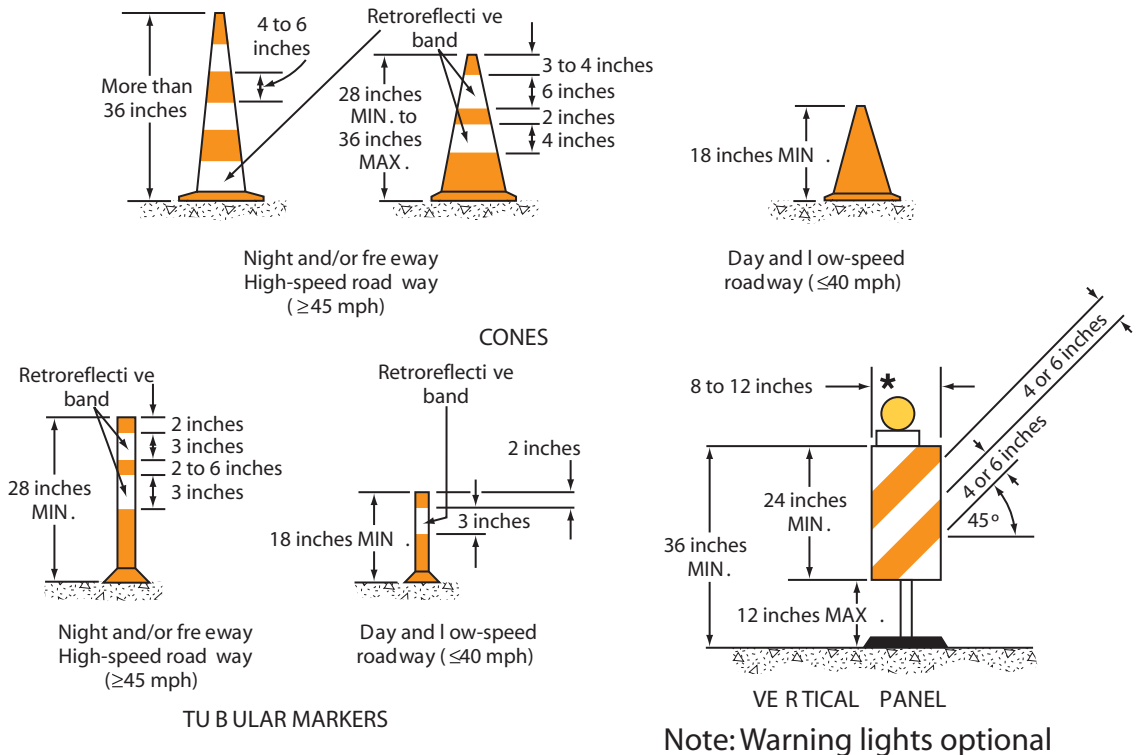

Devices used to channelize pedestrians shall be detectable to users of long canes and visible to persons having low vision. Where channelizing devices are used to channelize pedestrians, they shall be continuous detectable bottom and top surfaces to be detectable to users of long canes. The bottom of the bottom surface shall be no higher than 2 inches above the ground. The top of the top surface shall be no lower than 32 inches above the ground.

The Problem

**CONES, TUBULAR MARKERS AND VERTICAL PANELS ARE USED TO DELINEATE OR CHANNELIZE TRAFFIC:** Since these words may be new to you, let's quickly define them. When cones are used to mark the side of a road, they are used as DELINEATORS. When cones are being used to divert traffic from two lanes into one, they are used for CHANNELIZING purposes. For example, have you ever been driving along a road and come to a long set of cones which gradually move all the traffic around an obstacle or into another lane? Tubular Markers and Cones are often used to form "tapers"--sets of cones individually placed to form a line which will be used to channelize traffic into more desirable areas.

Using Barrels - - An Example

**There is one problem with cones. Because they are so lightweight, they may be blown over in high winds or from the wind generated by passing vehicles. And, when cones are blown over, they no longer serve as effective traffic control devices because they are no longer visible.** In fact, cones which have blown over may even cause accidents, as motorists may try to dodge these devices in order to keep from running over them. Sometimes the traffic control supervisor will stack two or three cones together to keep them from being blown over. When you notice that cones have been knocked over or blown over, be sure that you notify the traffic control supervisor or some other authorized person so that the cones can be replaced or if necessary repaired. **NEVER LEAVE YOUR STATION TO PICK UP AND RESET CONES.**

**DRUMS OR BARRELS:**

Drums or barrels are very effective devices for channelizing traffic, and traffic control supervisors use them often for this purpose. Drums are always retroreflectorized with ORANGE and WHITE bands. **Because they are so large, they are very visible to the motorists and thus are effective in blocking off areas to protect the work crew from oncoming cars.** Sometimes the drums or barrels are ballasted with sandbags or water in them to keep them in place. However they will not be so heavily weighted as to be hazardous if struck by a car or truck. Let's look at an example of how barrels or drums may be used. The ballasting should never be placed on top of a drum.

Suppose a street is being widened and as a result, the existing pavement must be clearly marked so drivers will not drive off the road into the construction area. **Barrels may be used along the edge of the pavement to keep the motorists from driving in the unfinished lanes.** When the crew is actually working, the barrels may be placed in the roadway. This way traffic can be channelized smoothly and effectively into the open part of the roadway, and the workers will be protected.

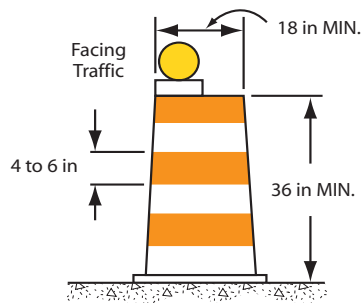

**Typical Drum**

There shall be at least two orange and two white horizontal, circumferential, retro-reflective bands on each drum.

DRUM  
Note: Warning lights optional

Because drums are bulky and sometimes are heavy they are used most often on projects which are of long duration. They also require much more room than cones. **Therefore, generally speaking, drums are not used often on routine maintenance project or projects of short duration.** This is because barrels are heavier than cones, and lack the portability of cones.

## BARRICADES:

### Using Barricades

Barricades are often used by traffic control supervisors on construction projects because of their high visibility and the protection they afford the work crew and the motorists. There are three types of barricades normally used on construction projects. Some of these barricades are more portable and may be used on short projects. And, some are more permanent structures and are used on relatively long-term projects. **Barricades are very good devices to use to outline excavation or construction areas in a street. Barricades are also used along with other types of traffic control devices such as cones or drums.** Almost all the time, you will find advance warning signs used ahead of barricades.

All barricades are marked with orange and white alternating stripes. Also, these stripes slope DOWN on the side where autos and trucks must pass. In addition, these devices are always reflectorized. Let's look at the four types of barricades which may be used.

### Type I Barricades - - Limited Portability

**TYPE I BARRICADES:** Type I barricades have just ONE retroreflectorized rail. **Type I barricades are portable and can be moved from job site to job site. However, they are not as portable as cones or even drums.** The Type I barricade is constructed so that it can be taken apart and reassembled fairly easily.

**Type I barricades may be used on construction projects where cars are still being allowed to pass through areas that are being constructed or reconstructed. They may also be used for emergency repair work. Type I barricades are predominantly used on low speed roads.**

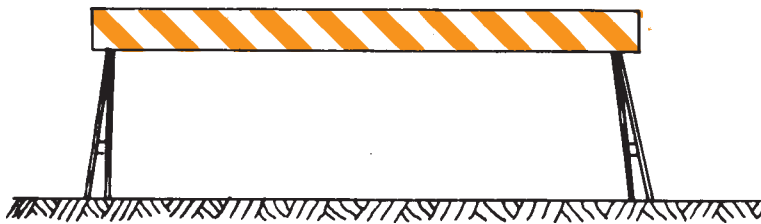

TYPE I BARRICADE

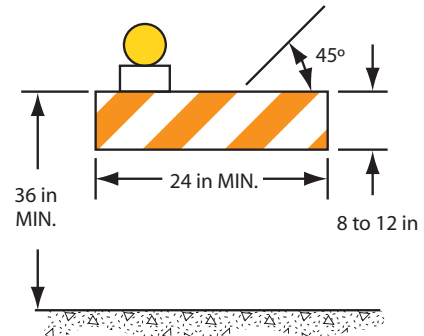

TYPE I BARRICADE

Note: Warning lights optional

### Using Type II Barricades

**TYPE II BARRICADES:** Type II barricades have TWO retroreflectorized rails that are supported horizontally on a frame. Type II barricades are a bit LESS portable than Type I barricades, but still can be moved with some degree of ease. **Type II barricades are predominantly used on high speed roads.**



TYPE II BARRICADE

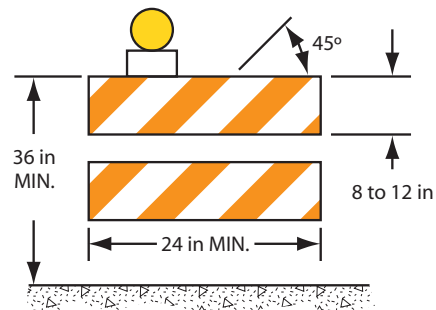

TYPE II BARRICADE

Note: Warning lights optional

**Using Type III Barricades**

**TYPE III BARRICADES:** Type III barricades are fairly permanent structures. These barricades have THREE retroreflectorized rails. Type III barricades are frequently used to indicate closed roads, or areas where construction will be on-going for quite a long period of time. “Road Closed” signs and proper “DetourArrow” signs shall be used on Type III barricades. If it is necessary to allow local traffic or heavy equipment to move through the construction area, then gates may be set up in the barricade. This way the limited traffic, such as local traffic, can pass without allowing a steady stream of vehicles through the area.

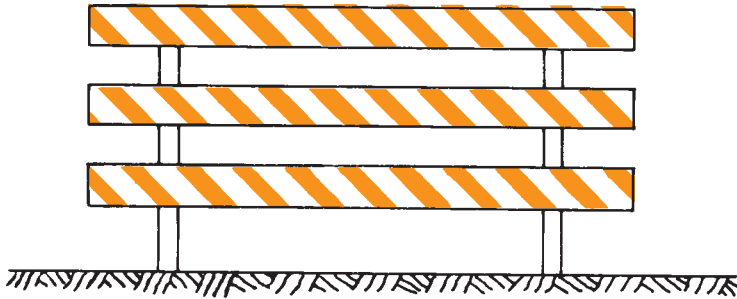

TYPE III BARRICADE

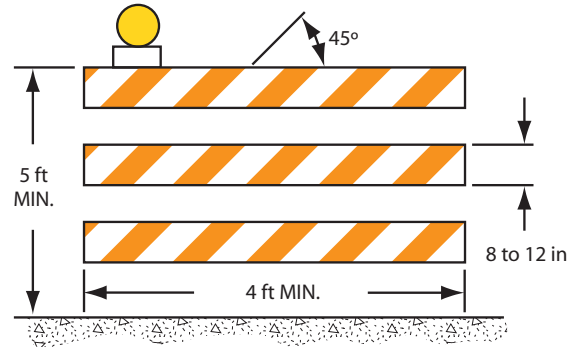

TYPE III BARRICADE  
Note: Warning lights optional

**Using Barricades With Lights**

When any types of barricades or drums are used around isolated objects at night, there may be “FLASHERS” (flashing lights) mounted on the barricade to catch the motorists’ and pedestrians’ attention. Lights on barricades being used for channelization at night shall be STEADY BURNING. Lights shall be mounted nearest to the traffic, if flashing lights are set on barricades used for channelization, they will confuse motorist and make visibility difficult.

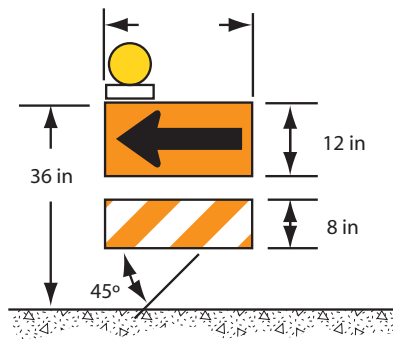

DIRECTION INDICATOR BARRICADE  
Note: Warning lights optional

**DIRECTION INDICATOR BARRICADES:** The Direction Indicator Barricade consists of a One-Direction Large Arrow sign mounted above a diagonally striped, horizontally aligned, retroreflective rail. The Direction Indicator Barricade are typically used in tapers, transitions, and other areas where specific directional guidance to drivers is necessary. If used, Direction Indicator Barricades should be used in series to direct the driver through the transition and into the intended travel lane.

## TRAFFIC CONTROL DEVICES--EXERCISE C:

(Please record your answers on a separate sheet of paper. Answers are on next page.)

- 1) Which of the following types of barricades may be used for short duration or temporary jobs?
  - a) Type I barricades
  - b) Type II barricades
  - c) Type III barricades
  - d) All of the above
- 2) Which of the following devices is most often used to make a taper?
  - a) Barrels
  - b) Cones
  - c) Type III barricades
- 3) True or false? Drums may often be weighted so that they are not blown or knocked into the roadway.
- 4) True or false? Type I barricades have two horizontal bars, which are striped orange and white.
- 5) True or false? If a barricade of any type is used, the stripes must point in a downward direction on the side traffic will be passing.
- 6) True or false? Cones are always 18" in height.
- 7) True or false? Any traffic control device which will be used at night should be reflectorized.
- 8) Which of the following barricades might be used if there is an emergency situation, such as a washout?
  - a) Type I barricades
  - b) Type II barricades
  - c) Either Type I or Type II barricades
- 9) True or false? When traffic is being channelized, it generally means traffic is being diverted either to another lane or to another location or being kept away from road work activities.

**TRAFFIC CONTROL DEVICES--ANSWERS TO EXERCISE C:**

- 1) d
- 2) b
- 3) True, but never to the extent that they become a hazard if they are struck by a car or passing vehicle.
- 4) False. Type I barricades have one horizontal rail.
- 5) True
- 6) False
- 7) True
- 8) c
- 9) True

# **SECTION D**

## **TOOLS OF THE TRADE**

### **STOP/SLOW PADDLES**

One piece of equipment that you will be predominantly be using is the “STOP/SLOW” paddle. This sign is mounted on a rigid staff. It is designed so that the staff rests on the ground and the paddle sign is clearly visible to the motorist.

There are, however, paddle signs which are not mounted on a staff. These are hand-held signs. The sign itself should be at least 18 inches high, with letters that are at least 6 inches high. The sign, is two-sided. **One side of the paddle sign is the “STOP” sign, and the other is the “SLOW” sign. The “STOP” side of the sign has a red background and white letters, the “SLOW” side of the sign is orange with black letters.** If the STOP/SLOW paddle is used at night, it shall be retroreflectorized.



The STOP/SLOW paddle may be modified to improve conspicuity by incorporating either white or red flashing lights on the STOP face, and either white or yellow flashing lights on the SLOW face. The flashing lights shall be arranged in accordance with the most current MUTCD.

#### **Paddle Signs**

What is this paddle used for? **The flagger stands at his flag station and holds the paddle in an upright position. If traffic is to be stopped, the “STOP” portion of the sign directly faces the oncoming traffic. If traffic is to be slowed down, and not stopped, the “SLOW” portion of the sign faces traffic.** You will read more about how you will use this sign with flagging movements later in this manual.

### **FLAGS**

Flag use should be limited to emergency situations and at spot locations which can best be controlled by a single flagger. When used at night, flags shall be retroreflectorized RED.

Flags shall be a minimum of 24 by 24 inches in size, made of good grade of RED or fluorescent orange/red material securely fastened to a staff approximately 3 feet in length. The free edge should be weighted to ensure that the flag will hang vertically, even in heavy winds.

### **LIGHTED WANDS OR FLASHLIGHTS**

If you are flagging at night, you should be given a flashlight with a red lighted cone on the end. The lighted part of the flashlight will be RED and at least 6 inches in length. It should be clearly visible to motorists. Again, you will use this device to help control traffic. However, you may be issued a LIGHTED WAND. These are generally at least 30 inches long and look almost space-age. Again, they are very effective and very visible. You will learn more about how you will actually use these tools later.



## **RADIOS**

There are several types of radios used to improve safety. Your supervisor may give you a radio to use in certain situations.

## **AUTOMATED FLAGGER ASSISTANCE DEVICES (AFADS)**

Automated Flagger Assistance Devices (AFADs) enable a flagger(s) to be positioned out of the lane of traffic and are used to control road users through temporary traffic control zones. These devices are designed to be remotely operated either by a single flagger at one end of the TTC zone or at a central location, or by separate flaggers near each device's location.

There are two types of AFADs:

- A. An AFAD (see Section 6E.05 of the 2009 MUTCD) that uses a remotely controlled STOP/SLOW sign on either a trailer or a movable cart system to alternately control right-of-way
- B. An AFAD (see Section 6E.06 of the 2009 MUTCD) that uses remotely controlled red and yellow lenses and a gate arm to alternately control right-of-way

Typical applications include TTC activities such as, but not limited to:

- A. Bridge maintenance;
- B. Haul road crossings; and
- C. Pavement patching.

## **TOOLS OF THE TRADE--EXERCISE D:**

(Please record your answers on a separate sheet of paper. Answers are on next page.)

- 1) True or false? You may use a "STOP/SLOW" paddle in your work.
- 2) True or false? The "STOP" side of the paddle is always red with white letters.
- 3) True or false? You may use the "STOP/SLOW" paddle at night.
- 4) True or false? You may use flags at night.
- 5) True or false? A flashlight with a red lighted cone at least 6 inches long may be used at night.

**TOOLS OF THE TRADE--ANSWERS TO EXERCISE D:**

- 1) True
- 2) True
- 3) True. But the paddle should be retroreflectorized. If it is not, then you will not be able to use it at night.
- 4) True if retroreflectorized red.
- 5) True. Or, a lighted wand (at least 30 inches in length) may be used.

# **SECTION E**

## **DRESSING FOR THE JOB**

Earlier in this manual, you read about the various duties you will perform and the equipment you will be using. Now you should know about the clothing you will wear on the job. And, this is very important. Not only is the clothing you must wear very important for SAFETY REASONS, some of it is MANDATORY. That is, it MUST be worn by law. Let's look at some of the reasons why you must be appropriately dressed.

### **Dress Is Important**

First, VISIBILITY is very important. **As a flagger you must be visible both day and night.** This will keep you from being accidentally struck by either a private vehicle or by the work crew operating equipment. **Secondly, wearing the proper clothing will protect you from the elements.** For example, you may be working during the summer months when it is extremely hot and sunny. And, while wearing shorts or a bathing suit may seem ideal, you are running the risk of becoming very sunburned, and eventually severely ill. Unless you are clothed properly, you might find yourself covered with hot oil, or tar--both of which can give you a very nasty burn. Also in some areas of Colorado there are lots of bugs that will feast on any uncovered portions of your body. Wearing the right clothing helps you to protect yourself.

The third reason for wearing the proper clothing is standardization--it will help you be recognized as a flagger, whose responsibility is safety. If motorists see you dressed inappropriately, you will not be able to command respect from either the motorists or the work crew. And, in fact, eye-catching apparel may even be dangerous. You may cause an accident. For example, a motorist may be more interested in staring at you, than concentrating on driving. Thus, a flag station is no place for getting a tan or wearing inappropriate clothing. Flagging is a serious responsibility and YOU MUST BE DRESSED APPROPRIATELY. Let's look at what you should wear now

## **HIGH-VISIBILITY SAFETY APPAREL**

For daytime and nighttime activity flaggers shall wear safety apparel meeting the requirements of ISEA "American National Standard for High-Visibility Apparel", and labeled as meeting the ANSI 107-1999 standard performance for Class 2 or Class 3 risk exposure. The apparel material shall be either fluorescent orange-red or fluorescent yellow-green as defined in the standard. The retroreflective material color shall be either orange, yellow, white, silver, yellow-green, or a fluorescent version of these colors, and shall be visible at a minimum distance of 1,000 ft. The retroreflective safety apparel shall be designed to clearly identify the wearer as a person.

For nighttime activity, safety apparel meeting the requirements of ISEA "American National Standard for High-Visibility Apparel" and labeled as meeting the ANSI 107-1999 standard performance for Class 3 risk exposure should be considered for flagger wear (instead of the Class 2 safety apparel in the standard above).

When uniformed law enforcement officers are used, high-visibility safety apparel as described in this section should be worn by the law enforcement officer.

## **A SAFETY VEST**

### **Why Safety Vests Are Important**

This item of clothing is required by law. Any time that you are acting in a flagging position, YOU MUST WEAR A SAFETY VEST, SHIRT OR JACKET that meets ISEA and ANSI standards. Why do you need to wear an approved vest?

There are several good reasons. **First--it makes you very visible. Second--it is part of the recognized standard uniform for flaggers. Third--it is required by CDOT.** Thus, NEVER take up your flagging position without wearing an approved vest. If you do not wear an approved vest, you may be dismissed from the job.

## HARD HAT

### Why Wear a Hard Hat

This item of clothing is also mandatory, and required by CDOT. YOU MUST WEAR EITHER A FLUORESCENT ORANGE-RED OR FLUORESCENT YELLOW-GREEN HARD HAT. Why? **Wearing a hard hat identifies you as part of the work crew to both motorists and the construction crew. And, a hard hat will protect your head from flying debris and other dangers. Finally, the hard hat is part of the recognized uniform for flaggers.** Remember, you must always wear a hard hat in your work--not only for safety and visibility, but also as an identification badge.

## SHOES

**Always wear substantial shoes or work boots.** First of all, road surfaces tend to get very hot and heavy shoes will protect your feet. You may also be working in rocky or uneven surface areas and hard shoes will help you keep your footing and protect you from sharp rocks. Tennis shoes won't protect your feet in this case, but heavy work boots might. **Finally, it just makes good common sense to wear work boots or heavy shoes around construction equipment.**

## OTHER THINGS YOU MAY NEED

### Optional Items

There are other types of clothing you may need to wear. In some areas where heavy dust may be a problem, **you may need to ask for and wear a dust mask. Or, if loud, potentially damaging noises are a problem, you may need to wear ear plugs. Long sleeved shirts and pants will not only protect you from dust, oil and tar, but also will keep you from becoming overexposed to the sun or insects. Heavy gloves in the winter or light gloves in the summer will serve the same general purposes--protection and comfort.** If you wear contact lenses, you may find that dust will irritate your eyes. Thus, you may want to wear a pair of prescription glasses instead.

Remember, your job may expose you to hot and dusty or cold and rainy weather situations. Because you will be exposed to this kind of weather for long periods of time, you MUST take steps so that you are protected and comfortable.

If you have never worked as a flagger or spent a lot of time outdoors, ask some of the other crew members or your supervisor what types of personal clothing are appropriate. In the long run, if you use common sense and good judgment in your clothing, you will be much safer and definitely more comfortable. Remember, a flagger has a serious responsibility and an important job. You must dress so that you are VISIBLE, SAFE AND COMFORTABLE. Also, remember, **you MUST always wear an approved vest and hard hat.** Sturdy shoes are highly recommended.

Failure to dress in the right manner may mean that you will be replaced or dismissed from the job. So consider your clothing carefully--it is crucial for safety.

You have now learned about what you MUST wear on the job and what items of clothing are recommended. Before you read any further about how you will act on the job, take a few minutes and complete the following exercise. It will help you remember what you have read.

## CLOTHING YOU MUST WEAR--EXERCISE E:

(Please record your answers on a separate sheet of paper. Answers are on next page.)

- 1) True or false? You MUST wear gloves at all times.
- 2) Which of the following items are you required to wear on the job?
  - a) A red bandana
  - b) Hard Toed Shoes
  - c) An orange hard hat
  - d) A dust mask
  - e) An approved vest
- 3) True or false? One of the reasons you must wear certain items of clothing is so that you are visible to both the drivers and the work crew
- 4) True or false? Short shorts or similar clothing is inappropriate to wear on the job.
- 5) True or false? Clothing, such as a vest, must be retroreflectorized when work-

### **CLOTHING YOU MUST WEAR--ANSWERS TO EXERCISE E:**

- 1) False. Although gloves are recommended for safety and comfort, they are not a required item of clothing.
- 2) c and e.
- 3) True
- 4) True. Not only does this type of clothing expose you to too much sun, insect bites and splattering oil, it may cause accidents. If motorists are more interested in what you are wearing than the job you are performing, accidents may occur.
- 5) True. Remember, retroreflectorized clothing helps you to be seen and thus, get your job done more safely and efficiently.

# **SECTION F**

## **YOUR JOB DUTIES**

You have some major responsibilities. They are:

- Protecting yourself and your fellow employees from the motoring public;
- Protecting the public from construction dangers:
- Guiding traffic efficiently through a work area.
- Using your skills and intelligence to accomplish the above goals.

However, as these are only your major responsibilities, you will have many duties oask to perform in order to obtain these goals. Let's look at some of the basic items you need to know about in order to do your job as a flagger efficiently and well.

### **Know About Traffic Regulations**

**First you will need to have a good working knowledge of normal traffic laws and regulations, as well as the more technical duties you must know as a flagger.** However, keep in mind that as a flagger you are not the "law ." That is, you do not have the LEGAL AUTHORITY that police officers have to regulate, control or direct traffic. Uniformed police officers are responsible for traffic control in signalized intersections, not flaggers. Flaggers are not authorized to override a red light. While the traveling public SHOULD obey your directions, and SHOULD treat you with respect, you do not have the same kinds of legal recourse (ticketing, arresting) that police officers have.

### **... Flagging Techniques...**

**Second, you should be aware of all--and be able to use all--the flagging techniques you can use on your job. This includes not only the actual flagging movements, but also equipment you will be using--such as the different signs, and traffic control devices.**

### **... Dressing For the Job...**

**Third, you should know how to dress appropriately for the job. This is for safety and visibility reasons and for overall consistency so that your authority is not questioned.**

### **... The Construction Situation**

You must also know about the situation you will be working in. Remember sometimes you will be the only link that the motoring public may have with the construction area and crew. **Thus, you must be able to answer questions intelligently when asked. You should know what kind of construction work is being done.** Is it routine and quick road maintenance? Is major construction involved? Are traffic hazards present, such as road obstacles, fresh oil? How long will the work take? Will the delay for the motorists be short or long? If you are going to stop traffic for any length of time, you should be able to provide waiting motorists with accurate information. If there is a detour route involved, you should be able to give directions to motorists who may be unfamiliar with the area.

### **Flaggers and Public Relations**

In light of your role as the public's link with the construction **job, you must ALWAYS see yourself as a sort of public relations person. You should be polite, answer questions to the best of your knowledge and make every attempt to help the traveling public.** Remember, your slowing or stopping traffic may be frustrating to those motorists who are in a hurry, or who do not understand what is going on in the area. You may need to explain what is going on, and how long it will take, and the hazards that are to be expected to any one who asks. Remember a smile and a polite answer will go a long way in making the public more comfortable and less frustrated.

### **Always Be Aware**

Because a flagger is responsible for the safety of many lives, you must always be alert. Do not relax on the job or, **sit on the ground, because these actions make you less visible and less able to perform your role as a traffic and safety monitor.** In addition, these things may very well put YOU in danger! An inattentive flagger cannot respond quickly to an emergency situation. Thus, **ALWAYS BE ON YOUR GUARD, NEVER LEAVE YOUR**

**FLAGGING STATION UNTIL YOU ARE RELIEVED BY ANOTHER TRAINED FLAGGER.**

A trained flagger is someone who has a good knowledge of the flagging functions and who is capable of handling the job. It does not mean the closest person to your stand. **The job is too important to give to an inexperienced, untrained person.**

**... of  
Weather**

You must also know your weather conditions and the impact it will have on your situation. **Although many construction crews do not work in adverse weather conditions such as snow, heavy fog or rain, you MUST know how to perform your job duties under these conditions.** It will take drivers longer to stop or slow down on wet or icy pavement. Thus, keep this factor in mind.

**... and  
Traffic  
Patterns**

You must know the traffic conditions. As a flagger, you may be working on busy high-speed highways; you may be working on rural country roads; or you may be working on single-lane roads. **In short, the speed and volume of the traffic, as well as the type of roadway may very well make a huge difference in your job. Be aware!**

**HOW YOU SHOULD ACT ON THE JOB**

As a flagger, you will serve as the construction project's main link with the public. The way you conduct yourself on the job should reflect well on the construction project as a whole. How should you act?

**Inform  
Drivers  
Briefly**

When dealing with the traveling public, you should always be calm, courteous and polite. Speak in a low tone of voice--don't shout at drivers. Smile--you can brighten someone's day, or lessen the frustration of a long delay at the worksite. **Always briefly inform the first driver of a line of cars of the situation at hand. Give this driver information about the job--what is going on and how long the delay is expected to be.** Answer any questions from other motorists as best you can.

**Stay  
Visible**

**Never lean on cars waiting in line.** This makes you look as if you are not doing your duty. It can also keep you from being seen. If you aren't visible, you'll find it very hard to get your job done.

**Don't  
Argue**

**Don't become involved in heated discussions with motorists.** In the same light, don't become involved in long drawn-out conversations with motorists. Remember, a brief, polite explanation will generally handle any situation.

**Control  
and Direct**

**Be firm--you have the authority to control and regulate traffic around or through worksites--you must exercise this authority firmly.** If you joke around with motorists or make them think your job is not important, you will not be taken seriously, and accidents may occur. Thus, be courteous and polite, but also be firm. Put yourself in the place of the motorists and treat them in the same manner which you would like to be treated.

**Handling  
Problems**

**If, however, you find yourself in a position where a careless or erratic driver does not obey your commands, such as a driver refusing to slow down to a reasonable speed to pass through a project site, try to get the license number of the vehicle. If you can't read the license number, be sure to get the make and color of the vehicle and if possible, a description of the driver.** You can report this information to your supervisor later. Someone else will be responsible for handling the situation. However, if you find a motorist does not obey you and places the work crew in a dangerous situation, try to warn the crew. Some flaggers may be equipped with radios, loud whistles, or air horns so that they can alert crew members and possibly prevent dangerous situations. However, use your head--do not chase a car on foot. And, do not try to hit a car with your paddle or sign.



**Alert the Crew**

**EMERGENCY VEHICLES:**

At times you may have emergency vehicles--fire trucks or ambulances, for example, trying to pass through your area at high speeds. You should try to warn these vehicles as you would any other driver of the construction situation ahead. It is, however, up to the driver of the emergency vehicle to decide whether or not to slow down. **If the emergency vehicle passes in spite of your warning or flagging efforts, you should try to alert the crew ahead.** If you have a radio, whistle, or air horn use it. However, you should not leave your station. Remember, behind the emergency vehicle will be other cars and trucks who will NEED to be controlled. Thus, use your COMMON SENSE and GOOD JUDGMENT when you become involved with fast moving emergency vehicles.

**Public Relations Are Vital**

Finally, always be alert--ALWAYS BE ON YOUR GUARD. Never become lazy on the job. You should know that you may spend long, hot, or cold days on the road. You may become tired and irritable. However, don't ever take this out on the public or your fellow workers. They may be just as tired, irritable or frustrated as you are, and this may lead to flaring tempers and a possible fight.

**Always remember that you are the public relations person for the construction project. So, act the part--be kind, courteous and polite.** Try to give the driver of the first car in line a brief explanation of the situation. Answer any questions from motorists politely and with a smile. If you can get them on their way safely, in comfort and well informed, you will be doing a great job.

**YOUR FLAGGING STATION**

One of the most important things you must know before you actually learn to flag is where your flagging station will be. Generally, you will find that the person who is responsible for traffic safety and control will be able to help you determine where you will stand.

Your flagging station is important for these reasons:

- You must be positioned so that you are clearly visible to oncoming traffic. This will help you control and direct traffic, as well as ensure your safety on the job.
- You must be stationed far enough ahead of the work site so that cars and even heavily loaded trucks can slow down enough to stop.
- You must be close enough to the work being done to protect your fellow workers.

How will you do this? How far away from the work should you be? A lot of this depends on the road conditions--the speed of the traffic and the volume or number of cars and trucks traveling on the road. While you will not be responsible for figuring out exactly where you should stand, you should have some idea of the factors involved in choosing a good place to stand. And, once you have found the correct place to use for a flagging station, there are other requirements you should know about. Let's look at this now.

**Be Visible**













**WHERE TO STAND**

To be an effective flagger, you MUST stand where you can be seen. **Do NOT stand in the shade, behind a rock or next to a car. Do not park your own car near your flagging station. CDOT recommends personal vehicles be 200 feet away. Do NOT stand just over the crest of a hill or just around a curve in a road. In addition, always take a quick look around to make sure your clothing contrasts with the background.** Then, ask yourself can I be seen? Is there anything which will hide me from the view of either the passing motorists or the work crew? Am I so close to the work crew that cars and trucks will not have time to slow down before entering the area? How fast are the cars and trucks coming? If you feel you are not visible to cars, or that you may be too close to the work area and cars are coming at too great a speed to stop--tell your supervisor

**Factors to Consider**

There are other factors which may make a difference as to where you should stand. **If you are working a project in an urban area, for example, in downtown Denver, you will probably be closer to the work crew than if you were working on Interstate 25.** Why? Because cars and trucks traveling in an urban situation will generally be going much slower and thus be able to slow down or stop faster than cars traveling on a higher speed roadway.

Be sure that the cars and trucks, no matter where you are standing, have enough room to stop. This generally can be explained by looking at the stopping distances chart which is provided below. Be sure you read and understand the stopping distance chart. In addition, when trying to figure out how long it will take a truck to stop, you should always assume that the truck is fully and heavily loaded. And, a heavily loaded truck will take a greater amount of distance and time to stop. This is especially true if the truck is traveling down a hill or steep grade.

SPEED (MPH)	SPEED (FPS)	Stopping Sight Distance	<b>SPEED AND STOPPING DISTANCES</b>	
20	29	115		
25	37	155		
30	44	200		
35	51	250		
40	59	305		
45	66	360		
50	73	425		
55	81	495		
60	88	570		
65	95	645		
70	103	730		
75	110	820		

**Where to Stand**

**Generally speaking, you should always stand on the shoulder which is NEXT to the lane of traffic you will be directing. Do not stand IN THE TRAVELED OR OPEN LANE.** That is the fastest way to get struck by a moving vehicle. Also, do not stand so far OFF the shoulder that you cannot be seen by the oncoming cars. **If a traffic lane has been barricaded or blocked--then you may stand in that lane.**

**CURVES:**

You read earlier about not standing just over the crest of a hill. In addition, you should never stand on the blind side of a curve. Up and down “dips” like hills are known as “VERTICAL CURVES.” As you know, when you are in a car, you never pass on a curve. Why? Because you can’t see what is coming the other way. This is also the reason why you should never stand on a curve--either horizontal or vertical--where you can’t be seen. **If you do stand just over the crest of a hill or on the back side of a curve, cars will not be able to see you far enough in advance to stop. And, if one car is able to stop in time, what about the car right behind him?** He will come around a curve and probably run right into the rear of the first car

**Curves are Dangerous**

As you can see, standing where you can't be seen can cause accidents. Accidents where you and your fellow workers or innocent drivers may be the victims. Also, when you get to your assigned position, look around to make sure you have an emergency escape route to use if necessary.

## FLAGGING AT NIGHT

Nighttime flagging can be a very dangerous situation. However, if you learn about what you should and should not do at night, then you can assure yourself and the crew of safe operations. As you may know, a lot of maintenance and construction work is done at night when there are fewer cars on the road. Here are a few things you should always remember.

- ALWAYS WEAR RETROREFLECTORIZED HARD HATS AND VESTS. You must be sure to do this--it may be one of the only ways you can keep yourself from being involved in an accident.
- ALWAYS HAVE RETROREFLECTORIZED TOOLS--such as flashlights, lighted wands, paddles and signs.

In addition, at night, your flag station SHALL ALWAYS BE LIGHTED. The only exception is in case of an emergency. Your supervisor will generally be responsible for making sure that your station is lighted. DO NOT FLAG AT A STATION WHICH IS NOT LIGHTED. Why? Even with retroreflectORIZED clothing and equipment, you may not be visible to traffic--especially if it is foggy or raining, or even snowing. The lighting devices must not shine into the eyes of the drivers. If they do, they may temporarily blind the drivers, causing them to either hit you or lose control of the car and drive into the construction site. However, you should be aware that you will not be responsible for setting up the lighting at your station. You may, however, be asked to help. But you should know enough about the lighting system, so that you can bring up a potential problem, should one arise.

## A FEW TIPS:

There are a couple of other rules you should understand.

- **NEVER mingle with the work crew while you are on the job.** The public won't know if you are a flagger or not. You can't expect them to pick the flagger out of a group of people who are all dressed alike. Thus, stand alone and well away from the crew.
- **Remember, DO NOT LEAVE your flagging station unless you are relieved by a trained, appropriately dressed flagger.** Your job is much too important to let just anybody handle the duties.
- **Always have an escape route in mind.**

Finally, no matter where your flagging position may be, there should ALWAYS be advance warning signs to alert motorists to your presence. Thus, flagging stations must always be protected by advance warning signs. If signs have not been placed, be sure to alert your supervisor to this fact.

The most important thing you should remember about your flagging position and your job is to USE YOUR HEAD. Don't get caught in a potentially hazardous situation. If you have questions or doubts about your assigned position, be sure to tell your supervisor. If you don't, the loss may not only be in property, but in lives.

You now have learned about what you should wear where you should stand and how you should act on the job, as well as many other things. Now you will learn HOW to actually flag. But before you get into that subject, complete the following review exercise. Remember if you miss any questions, you should go back and reread the material.

### WHERE TO STAND--EXERCISE F:

(Please record your answers on a separate sheet of paper. Answers are on next page.)

- 1) You should always stand:
  - a) On the curve in the road
  - b) Just over the crest of a hill
  - c) Where you can be seen
- 2) Which of the following should you not do as a flagger on duty:
  - a) Indulge in idle conversation with your co-workers
  - b) Stand with a group of people
  - c) Recline or sit on the ground to flag
  - d) Turn your back on traffic
  - e) all of the above
- 3) True or false? You should always stand on the shoulder of the road or in a properly marked off area.
- 4) True or false? You should always face the traffic you are attempting to control?
- 5) True or false? If you need to take a break, or stretch your legs, it's OK to leave your flag station if there are no cars coming.
- 6) True or false? If you must leave your flag station, you should make sure that a trained and properly dressed flagger is there to relieve you.
- 7) True or false? You should always stand exactly 300 feet from the construction site.
- 8) True or false? You will never be expected to make decisions on the job.
- 9) True or false? Your flag station will depend on several factors, such as where the construction is being done, how fast traffic is coming, how high the volume of traffic is and the type of construction being performed.
- 10) True or false? You should always stand alone.

## WHERE TO STAND--ANSWERS TO EXERCISE F:

- 1) c
- 2) e
- 3) True
- 4) True
- 5) False. You should never leave your station unless you are relieved by a trained flagger
- 6) True
- 7) False. Your supervisor will help you decide where you will stand. There are no hard and fast rules concerning where you must stand. You must stand far enough away from the work area so that cars and trucks can slow down or stop before they reach the area. And, you must stand near enough to the work area to protect those on the site.
- 8) False. You will be expected to use your head in all situations.
- 9) True. And, there may be other factors involved. This is why the traffic control supervisor or someone else in a position of authority will help assign you your flagging station.
- 10) True. However, there may be situations when you are paired with another flagger who will stand across a roadway, or even in advance of you. This is not considered to be standing with you.

# SECTION G

## HOW TO FLAG

There are three basic flagging functions that you will be performing. You will be:

- Stopping traffic.
- Releasing traffic which has been stopped.
- Slowing traffic.

Each of these functions will be performed differently. And there are different procedures for day and night time flagging. Let's look at how you will do each of these functions.

### DAYTIME FLAGGING

#### TO STOP TRAFFIC

**Make sure the paddle sign is held straight up--not leaning to the right or to the left. Do not wave your STOP/SLOW paddle.** Make sure that the front of the "STOP" side is directly facing traffic. This way, the sign will be visible to motorists. When traffic approaches hold out your free hand/arm, above shoulder level, with your palm facing traffic. This is a standard "STOP" hand signal. **IT IS VERY IMPORTANT** that you attempt to catch the driver's eye. It will help him become more aware of what you are doing. Keep your position, and maintain eye contact until the driver comes to a complete stop. Be firm! Make sure that the driver sees you.

**After the first vehicle has stopped, move to a clearly visible position near the center of the roadway or the left of the traveled lane.** Be sure that you don't move directly into traffic which may be coming the other way. Do not stand directly in front of the car you have just stopped. Remain in your "STOP" position until it is time to release your traffic to travel through the area.

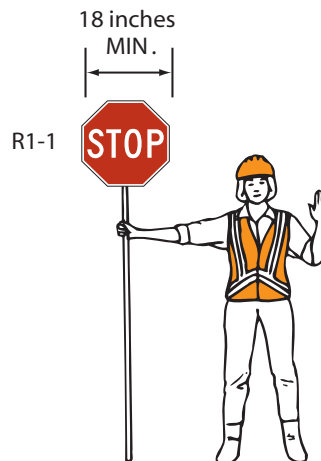

#### TO RELEASE TRAFFIC

When it is safe to let traffic proceed, you should move to the right of traffic and stand directly facing the traffic flow. Only then turn the "STOP/SLOW" paddle to "SLOW". Using **slow** arm movements, motion for the traffic to proceed.

Hold  
Paddles  
Straight

Maintain  
Eye Con-  
tact

Move to  
Center

Show  
"Slow"  
Sign

W20-8



### TO SLOW TRAFFIC

#### Hand Signals

Face the traffic and hold the paddle upright just as you would to stop traffic. **Be sure that the "SLOW" portion of the paddle is facing traffic. If you need to emphasize your position, raise and lower your free arm slowly in front of you, with your palm parallel to the ground.** Be sure to make eye contact with each driver. If you are only trying to warn or alert traffic to the construction ahead, but do not need to slow the speed of the cars greatly, stand in your position on the side of the road, or in a barricaded lane facing traffic and display the "SLOW" side of your paddle



### NIGHT TIME FLAGGING

#### Reflectorized Equipment

As you have read, night time flagging is a whole different ball game. **Remember, everything that you use, vests, hard hats, paddles or signs must be retroreflectorized. In addition, your flagging stand shall also be lighted.** Thus, before you step out to perform your duties at night, make a quick check to be sure all of your equipment and required clothing is either retroreflectorized or has retroreflective tape on it. Also be certain that your retroreflectorized material can still be seen if it becomes wet. In addition, it is a good idea to wear light colored clothes under your vest at night. This will help you to be seen easily

### TO STOP TRAFFIC:

Be sure that your flag station is lighted. Then, stand on the shoulder of the road or barricaded area facing traffic. Hold the paddle sign as you have learned for daytime flagging. You may hold your free arm out, palm facing traffic to emphasize your motion.

#### Hold Flashlight Out

**If you are using a flashlight or wand, hold it in your free hand, with your arm in a horizontal position. Your arm should be about shoulder high.** (Be sure that if you have a flashlight, that the proper 6 inch red cone has been attached.) Slowly swing the flashlight or other lighted materials in a sweeping motion across your body. Do not swing the flashlight over your head. Keep your movements slow and deliberate and never swing the flashlight or wand above your shoulder

## TO RELEASE TRAFFIC

The signal you use to get traffic moving should be made by lowering your flashlight to your side, stand facing traffic and motion drivers ahead with a slow, sweeping motion of your flashlight or wand.

### Lower the Flashlight

## TO SLOW TRAFFIC

Stand in your lighted flag station, either on the shoulder of the road or in a clearly barricaded or marked area. Using the "SLOW" side of the paddle sign, you will slow traffic just as you have learned earlier. **Using a flashlight or wand, face the traffic, and slowly swing the light across your body, making sure that your arm does not swing above your shoulder.**

## USE OF FLAGS

Flag use should be limited to emergency situations and at spot locations which can best be controlled by a single flagger They may be used at night if retroreflectorized.

## TO STOP TRAFFIC

### Hand Signals

When you are allowed to use a flag to stop traffic, stand in a safe position either on the shoulder of the road or in a closed or barricaded lane. Face traffic and hold the flag out, about shoulder level so that it hangs into the edge of the traffic lane. **Make sure that the flag is fully extended, and not rolled up or crumpled.** Your palm should be facing the driver. This is a standard "stop" hand signal. Attempt to catch the driver's eye. Keep your position, and maintain eye contact until the driver comes to a complete stop. Be firm! Make sure that the driver sees you.

After the first vehicle has stopped, move to a clearly visible position near the center of the roadway or the left of the traveled lane. Be sure that you don't move directly into traffic which maybe coming the other way. And, do not stand directly in front of the car you have just stopped. Then remain in your "stop" position until it is time to release your traffic to travel through the area.

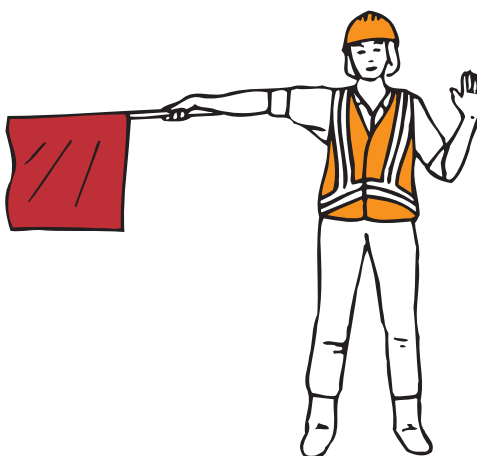



## TO RELEASE TRAFFIC

When it is safe to let traffic proceed, you should move back over to the right side of the lane of traffic. Stand parallel to the traffic. That means you will be facing the passenger's door on a car. Once on the shoulder of the road, put the flag down to your side, out of sight. **Then motion traffic to proceed with your free arm. Use slow deliberate movements of your arm.**



## TO SLOW TRAFFIC

Stand on the shoulder or a barricaded lane facing traffic. Hold the flag in a horizontal position, about shoulder level, just as you did to stop traffic. **Then, slowly wave the flag in a sweeping motion, without raising your arm above the shoulder. Do not madly wave or swing the flag. Make sure your movements are slow and sure.** If you are only trying to warn or alert traffic to the construction ahead, but do not need to slow the speed of the cars greatly, stand in your position on the side of the road, or in a barricaded lane facing traffic and use the same procedures you would to slow traffic.



## **FLAGGING IN NIGHTTIME EMERGENCY SITUATIONS IN A NON-ILLUMINATED FLAGGER STATION**

When flagging in an emergency situation at night in a non-illuminated flagger station, a flagger may use a flashlight with a red glow cone to supplement the STOP/SLOW paddle or flag. When a flashlight is used for flagging in an emergency situation at night in a non-illuminated flagger station, the flagger shall hold the flashlight in the left hand, shall hold the paddle or flag in the right hand and shall use the flashlight in the following manner to control approaching road users:

### **To Inform Road Users to Stop**

The flagger shall hold the flashlight with the left arm extended and pointed down toward the ground, and then shall slowly wave the flashlight in front of the body in a slow arc from left to right such that the arc reaches no farther than 45 degrees from vertical.

### **To Inform Road Users to Proceed**

The flagger shall point the flashlight at the vehicle's bumper, slowly aim the flashlight toward the open lane, then hold the flashlight in that position. The flagger shall not wave the flashlight.

### **To Alert or Slow Traffic**

The flagger shall point the flashlight toward oncoming traffic and quickly wave the flashlight in a figure eight motion.

## **FLAGGING WITH AUTOMATIC FLAGGER ASSISTANCE DEVICES (AFADS)**

Only use AFADs in situations where there is only one lane of approaching traffic in the direction to be controlled and when used at night, the AFAD location must be illuminated.

Because AFADs are not traffic control signals, they can not be used as a substitute for or a replacement for a continuously operating temporary traffic control signal.

AFADs should be located in advance of one-lane, two-way tapers and downstream from the point where approaching traffic is to stop in response to the device.

AFADs must be placed so that all of the signs and other items controlling traffic movement are readily visible to the driver of the initial approaching vehicle with advance warning signs alerting other approaching traffic to be prepared to stop.

An AFAD must be operated only by a flagger who has been trained on the operation of the AFAD. The flagger(s) operating the AFAD(s) must not leave the AFAD(s) unattended at any time while the AFAD(s) is being used.

The use of AFADs must conform to one of the following methods:

- A. An AFAD at each end of the TTC zone (Method 1), or
- B. An AFAD at one end of the TTC zone and a flagger at the opposite end (Method 2)

Two flaggers must be used when using either Method 1 or Method 2, except a single flagger may simultaneously operate two AFADs (Method 1) or may operate a single AFAD on one end of the TTC zone while being the flagger at the opposite end of the TTC zone (Method 2) if both of the following conditions are present:

- A. The flagger has an unobstructed view of the AFAD(s), and
- B. The flagger has an unobstructed view of approaching traffic in both directions.

When an AFAD is used, the advance warning signing should include a ROAD WORK AHEAD (W20-1) sign, a ONE LANE ROAD (W20-4) sign, and a BE PREPARED TO STOP (W3-4) sign.

When the AFAD is not in use, the signs associated with the AFAD, both at the AFAD location and in advance, must be removed or covered.

## HOW TO FLAG--EXERCISE G:

(Please record your answer on a separate sheet of paper. Answers are on page 42.)

- 1) True or false? When you are stopping or slowing traffic, you should always attempt to catch the driver's eye.
- 2) True or false? You will never use flags.
- 3) True or false? Once the first driver has come to a complete stop, you may move to a clearly visible position on or near the center of the roadway or to the left of the traveled lane. Then, you will resume your "stop" position.
- 4) True or false? When using a paddle sign, to release traffic you will return to your flag station at the road shoulder and stand facing traffic. Show the "slow" side of the sign and let the drivers proceed. You may also motion for the drivers to proceed with your free arm.
- 5) True or false? When using a paddle sign, to slow traffic you will stand in your normal position, facing traffic. Then, you will show the "slow" side of the paddle sign to traffic. With your free hand, you may make an up and down swinging motion in front of your body with your palm parallel to the ground.
- 6) True or false? Your flag stand must not be lighted at night.
- 7) True or false? You should never use a flammable lamp--such as a kerosene lamp--at night.
- 8) True or false? To release traffic, you will return to your flag station at the road shoulder or barricaded lane and stand parallel to traffic. If you are using a flag, you will lower it to your side, out of sight. Then, you will use your free arm to motion the drivers on.

## HOW TO FLAG--ANSWERS TO EXERCISE G:

- 1) True
- 2) False
- 3) True
- 4) True
- 5) True
- 6) False. Your flagging position shall be lighted at night.
- 7) True
- 8) True

# CONCLUSION

In this manual, you have learned quite a bit about being a flagger. As you have read, there is a lot you need to know BEFORE you can work as a flagger. Good traffic control and safety MUST be carefully planned and engineered. You must know what to do and what NOT to do. And, you must always keep your head. Flagging is not easy work, at times it may be boring and tedious. But you have some very important responsibilities as a flagger **You are responsible for guiding the motoring public efficiently through a work area, protecting the lives of yourself and your fellow workers and protecting the public from the potential dangers present in a construction area.**

As a flagger, you will also have the responsibility of serving as the main link between the motorist and the construction or maintenance crew. If these responsibilities sound very serious, they are. Your job will be tough, demanding, but if you can handle it, you will help protect and safeguard many lives.

Just to refresh your memory, here are a few general do's and don'ts--some of the most important you will need to remember.

- DO BE ALERT AT ALL TIMES. The difference could result in a loss of life/property.
- DO WEAR THE PROPER EQUIPMENT. You must wear an approved vest and hard hat. In addition, you may need to wear other personal comfort items.
- DO ACQUAINT YOURSELF at the start of a shift as to current operations and activities. Your ability to answer questions the conditions they are likely to encounter and how in general they should proceed, will all have the effect of sending them on their way informed, content and safe.
- DO TREAT EACH DRIVER as if he/she were the first one you've handled all day. As far as the driver is concerned, he/she may think they are the first one.
- DO BE EXTRA CAREFUL when you are flagging at night. Remember that motorists will have a lot more difficulty in seeing you and the construction dangers.
- DO BECOME FAMILIAR with all of the equipment and traffic control devices--you can only help yourself by being informed.
- DO CONSIDER ALL TRUCKS TO BE HEAVILY LOADED. You must understand that a heavily loaded truck will take a much longer time to stop.
- DO HAVE AN ESCAPE ROUTE IN MIND.
- DO NOT WAVE YOUR STOP/SLOW PADDLE.
- DO NOT READ OR LISTEN TO A RADIO WHILE ON DUTY. Don't take part in unnecessary conversations with motorists, pedestrians or your fellow crew members. Your job demands all of your attention.
- DO NOT STAND WITH A GROUP OF PEOPLE. Always stand alone. And, if possible make sure that there is contrast between you and the background.
- DO NOT LEAVE YOUR FLAG POSITION unless you are relieved by a certified flagger.
- DO NOT COME TO WORK IMPAIRED BY ALCOHOL, DRUGS, OR LACK OF SLEEP.
- DO NOT RECLINE, SIT OR SQUAT. It will not command respect from motorists. You will not be able to respond quickly to an emergency.
- DO NOT PARK YOUR CAR NEAR YOUR FLAGGING STATION.

These are some of the most important things you should remember. As a flagger, you will gain experience every day in your job. While there may seem to be a lot to learn now, after you work in the field for a while, things will become less confusing and you will have a better grip on the situation. WE WISH YOU LUCK AND SUCCESS IN YOUR JOB.

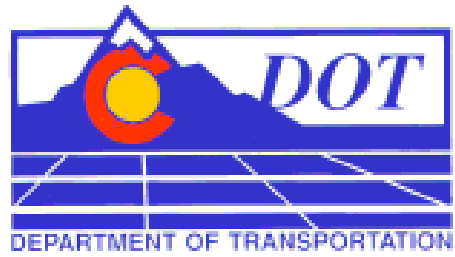

Colorado Department of Transportation  
Office of Transportation and Safety  
Attention: Flagging Certification Program  
4201 E. Arkansas Avenue  
Denver, CO 80222

1.888.639.3271

OR

[CDOT.Flagger@dot.state.co.us](mailto:CDOT.Flagger@dot.state.co.us)