

---

---

**Non-destructive testing of steel tubes —**  
**Part 6:**  
**Radiographic testing of the weld seam**  
**of welded steel tubes for the detection**  
**of imperfections**

*Essais non destructifs des tubes en acier —*

*Partie 6: Contrôle radiographique du cordon de soudure des tubes  
en acier soudés pour la détection des imperfections*



Reference number  
ISO 10893-6:2011(E)

© ISO 2011

**PDF disclaimer**

This PDF file may contain embedded typefaces. In accordance with Adobe's licensing policy, this file may be printed or viewed but shall not be edited unless the typefaces which are embedded are licensed to and installed on the computer performing the editing. In downloading this file, parties accept therein the responsibility of not infringing Adobe's licensing policy. The ISO Central Secretariat accepts no liability in this area.

Adobe is a trademark of Adobe Systems Incorporated.

Details of the software products used to create this PDF file can be found in the General Info relative to the file; the PDF-creation parameters were optimized for printing. Every care has been taken to ensure that the file is suitable for use by ISO member bodies. In the unlikely event that a problem relating to it is found, please inform the Central Secretariat at the address given below.



**COPYRIGHT PROTECTED DOCUMENT**

© ISO 2011

All rights reserved. Unless otherwise specified, no part of this publication may be reproduced or utilized in any form or by any means, electronic or mechanical, including photocopying and microfilm, without permission in writing from either ISO at the address below or ISO's member body in the country of the requester.

ISO copyright office  
Case postale 56 • CH-1211 Geneva 20  
Tel. + 41 22 749 01 11  
Fax + 41 22 749 09 47  
E-mail [copyright@iso.org](mailto:copyright@iso.org)  
Web [www.iso.org](http://www.iso.org)

Published in Switzerland

# Contents

Page

Foreword .....	iv
<b>1 Scope .....</b>	<b>1</b>
<b>2 Normative references .....</b>	<b>1</b>
<b>3 Terms and definitions .....</b>	<b>2</b>
<b>4 General requirements .....</b>	<b>2</b>
<b>5 Test method .....</b>	<b>3</b>
<b>6 Image quality .....</b>	<b>6</b>
<b>7 Processing of film .....</b>	<b>11</b>
<b>8 Viewing conditions for radiographs .....</b>	<b>11</b>
<b>9 Classification of indications .....</b>	<b>11</b>
<b>10 Acceptance limits .....</b>	<b>11</b>
<b>11 Acceptance .....</b>	<b>12</b>
<b>12 Test report .....</b>	<b>12</b>
<b>Annex A (informative) Examples of distribution of imperfections .....</b>	<b>13</b>

## Foreword

ISO (the International Organization for Standardization) is a worldwide federation of national standards bodies (ISO member bodies). The work of preparing International Standards is normally carried out through ISO technical committees. Each member body interested in a subject for which a technical committee has been established has the right to be represented on that committee. International organizations, governmental and non-governmental, in liaison with ISO, also take part in the work. ISO collaborates closely with the International Electrotechnical Commission (IEC) on all matters of electrotechnical standardization.

International Standards are drafted in accordance with the rules given in the ISO/IEC Directives, Part 2.

The main task of technical committees is to prepare International Standards. Draft International Standards adopted by the technical committees are circulated to the member bodies for voting. Publication as an International Standard requires approval by at least 75 % of the member bodies casting a vote.

Attention is drawn to the possibility that some of the elements of this document may be the subject of patent rights. ISO shall not be held responsible for identifying any or all such patent rights.

ISO 10893-6 was prepared by Technical Committee ISO/TC 17, *Steel*, Subcommittee SC 19, *Technical delivery conditions for steel tubes for pressure purposes*.

This first edition cancels and replaces ISO 12096:1996, which has been technically revised.

ISO 10893 consists of the following parts, under the general title *Non-destructive testing of steel tubes*:

- *Part 1: Automated electromagnetic testing of seamless and welded (except submerged arc-welded) steel tubes for the verification of hydraulic leaktightness*
- *Part 2: Automated eddy current testing of seamless and welded (except submerged arc-welded) steel tubes for the detection of imperfections*
- *Part 3: Automated full peripheral flux leakage testing of seamless and welded (except submerged arc-welded) ferromagnetic steel tubes for the detection of longitudinal and/or transverse imperfections*
- *Part 4: Liquid penetrant inspection of seamless and welded steel tubes for the detection of surface imperfections*
- *Part 5: Magnetic particle inspection of seamless and welded ferromagnetic steel tubes for the detection of surface imperfections*
- *Part 6: Radiographic testing of the weld seam of welded steel tubes for the detection of imperfections*
- *Part 7: Digital radiographic testing of the weld seam of welded steel tubes for the detection of imperfections*
- *Part 8: Automated ultrasonic testing of seamless and welded steel tubes for the detection of laminar imperfections*
- *Part 9: Automated ultrasonic testing for the detection of laminar imperfections in strip/plate used for the manufacture of welded steel tubes*
- *Part 10: Automated full peripheral ultrasonic testing of seamless and welded (except submerged arc-welded) steel tubes for the detection of longitudinal and/or transverse imperfections*

- *Part 11: Automated ultrasonic testing of the weld seam of welded steel tubes for the detection of longitudinal and/or transverse imperfections*
- *Part 12: Automated full peripheral ultrasonic thickness testing of seamless and welded (except submerged arc-welded) steel tubes*



# Non-destructive testing of steel tubes —

## Part 6: Radiographic testing of the weld seam of welded steel tubes for the detection of imperfections

### 1 Scope

This part of ISO 10893 specifies requirements for film-based radiographic X-ray testing of the longitudinal or helical weld seams of automated fusion arc-welded steel tubes for the detection of imperfections.

It can also be applicable to the testing of circular hollow sections.

NOTE As an alternative, see ISO 10893-7 for digital radiographic testing.

### 2 Normative references

The following referenced documents are indispensable for the application of this document. For dated references, only the edition cited applies. For undated references, the latest edition of the referenced document (including any amendments) applies.

ISO 5576, *Non-destructive testing — Industrial X-ray and gamma-ray radiology — Vocabulary*

ISO 5579, *Non-destructive testing — Radiographic examination of metallic materials by X- and gamma rays — Basic rules*

ISO 9712, *Non-destructive testing — Qualification and certification of personnel*

ISO 10893-7, *Non-destructive testing — Part 7: Digital radiographic testing of the weld seam of welded steel tubes for the detection of imperfections*

ISO 11484, *Steel products — Employer's qualification system for non-destructive testing (NDT) personnel*

ISO 11699-1, *Non-destructive testing — Industrial radiographic films — Part 1: Classification of film systems for industrial radiography*

ISO 17636, *Non-destructive testing of welds — Radiographic testing of fusion-welded joints*

ISO 19232-1, *Non-destructive testing — Image quality of radiographs — Part 1: Image quality indicators (wire type) — Determination of image quality value*

ISO 19232-2, *Non-destructive testing — Image quality of radiographs — Part 2: Image quality indicators (step/hole type) — Determination of image quality value*

### 3 Terms and definitions

For the purposes of this document, the terms and definitions given in ISO 5576 and ISO 11484 and the following apply.

- 3.1**  
**tube**  
hollow long product open at both ends, of any cross-sectional shape
- 3.2**  
**welded tube**  
tube made by forming a hollow profile from a flat product and welding adjacent edges together, and which after welding can be further processed, either hot or cold, into its final dimensions
- 3.3**  
**manufacturer**  
organization that manufactures products in accordance with the relevant standard(s) and declares the compliance of the delivered products with all applicable provisions of the relevant standard(s)
- 3.4**  
**agreement**  
contractual arrangement between the manufacturer and purchaser at the time of enquiry and order

### 4 General requirements

**4.1** Unless otherwise specified by the product standard or agreed on by the purchaser and manufacturer, a radiographic inspection shall be carried out on tubes after completion of all the primary production process operations (rolling, heat treating, cold and hot working, sizing, primary straightening, etc.).

**4.2** This inspection shall be carried out by trained operators qualified in accordance with ISO 9712, ISO 11484 or equivalent, and supervised by competent personnel nominated by the manufacturer. In the case of third-party inspection, this shall be agreed on between the purchaser and manufacturer.

The operating authorization issued by the employer shall be according to a written procedure. NDT operations shall be authorized by a level 3 NDT individual approved by the employer.

NOTE The definitions of level 1, 2 and 3 can be found in appropriate International Standards, e.g. ISO 9712 and ISO 11484.

**4.3** The tubes under test shall be sufficiently straight and free of foreign matter as to ensure the validity of the test. The surfaces of the weld seam and adjacent parent metal shall be sufficiently free of such foreign matter and surface irregularities which can interfere with the interpretation of the radiographs.

Surface grinding is permitted in order to achieve an acceptable surface finish.

**4.4** In cases where the weld reinforcement is removed, markers, usually in the form of lead arrows, shall be placed on each side of the weld such that its position can be identified on the radiograph.

**4.5** Identification symbols, usually in the form of lead letters, shall be placed on each section of the weld beam radiograph such that the images of these symbols appear in the radiograph to ensure unequivocal identification of the section.

**4.6** Permanent markings shall be provided on the source side of the tube surface to provide reference points for the accurate relocation of the position of each radiograph. Where the nature of the product or its intended service conditions render stamping impossible, other suitable means shall be provided for relocating the radiographs, e.g. by paint marking or reference to accurate sketches.



**4.7** When carrying out radiography of a continuous length of a weld with separate films, adjacent films shall overlap by at least 10 mm to ensure that no portion of the weld length remains unexamined.

## 5 Test method

**5.1** The weld of longitudinally or helically welded tubes shall be radiographically tested using the X-ray film technique. The application of non-film, digital radiographic techniques shall conform to ISO 10893-7.

**5.2** Two image quality classes A and B, in accordance with ISO 17636, shall be specified:

- class A: X-ray examination technique with standard sensitivity;
- class B: X-ray examination technique with enhanced sensitivity.

**NOTE** Most applications are covered by the use of image quality class A. Image quality class B is intended for more important and difficult applications where image quality class A can be insufficiently sensitive to reveal all the imperfections being detected. Image quality class B requires the use of film system class C4 or higher (fine grain films and lead screens) and, therefore, generally requires a longer exposure time. The required image quality class is usually stated in the relevant product standard.

**5.3** The film system class used shall be at least film system class C5 for image quality class A and shall be at least C4 (C3 for X-ray voltage < 150 kV) for image quality class B. (The classes are defined in ISO 5579, ISO 11699-1 and ISO 17636.)

The front intensifying metal screen, for both image quality class B and image quality class A, shall have a thickness of between 0,02 mm and 0,25 mm. Other thicknesses may be adopted for the back intensifying screen. In cases where a double film technique is used, both intensifying screens, if used, shall be in the upper thickness range of the front intensifying screen.

**5.4** Salt intensifying screens shall not be used.

**5.5** The amount of back-scattered and internally scattered X-ray radiation absorbed by the film shall be minimized.

If there is doubt regarding the adequacy of protection from back-scattered X-ray radiation, a characteristic symbol (typically, a 10 mm high lead letter, typically "B" and 1,5 mm thick) shall be attached to the back of the cassette or film holder and a radiograph shall be made in the normal manner. When the image of this symbol appears on the radiograph at a lighter density than the background, it is an indication that protection against back-scattered X-ray radiation is insufficient and it is essential that additional precautions be taken.

**5.6** The beam of radiation shall be directed at the centre of the section of the weld seam under examination and shall be normal to the tube surface at that point.

**5.7** The diagnostic length shall be such that the increase in penetrated thickness at the ends of the useful length of a radiograph shall not exceed the penetrated thickness at the centre of the radiograph by more than 10 % for image quality class B or by more than 20 % for image quality class A, provided the conditions specified in 5.11 and Clause 8 are not compromised.

**5.8** The single wall penetration technique shall be used. If this technique is impracticable for dimensional reasons, use of the double wall penetration technique is permitted by agreement.

**5.9** The separation between the film and the weld surface shall be as small as possible.

**5.10** The minimum value of the source-to-weld distance,  $f$ , shall be selected such that the ratio of this distance to the effective focal spot size  $d$ , i.e.  $f/d$ , conforms to the values given by the following formulae:

for image quality class A:

$$\frac{f}{d} \geq 7,5 \times b^{2/3} \quad (1)$$

for image quality class B:

$$\frac{f}{d} \geq 15 \times b^{2/3} \quad (2)$$

where

$b$  is the specified wall thickness in the direction of the radiation beam plus separation between the film and the surface remote from the radiation source, in millimetres.

NOTE These relationships are presented graphically in Figure 1.

**5.11** Exposure conditions shall be such that the density of the radiograph of the sound weld metal in the area under examination is not less than 2,3 for image quality class B and not less than 2,0 for image quality class A. Fog density shall not exceed 0,3. Fog density (here) is defined as the total density (emulsion and base) of a processed, unexposed film.

**5.12** To maintain sufficient sensitivity, the X-ray tube voltage should not exceed the maximum values given in Figure 2.

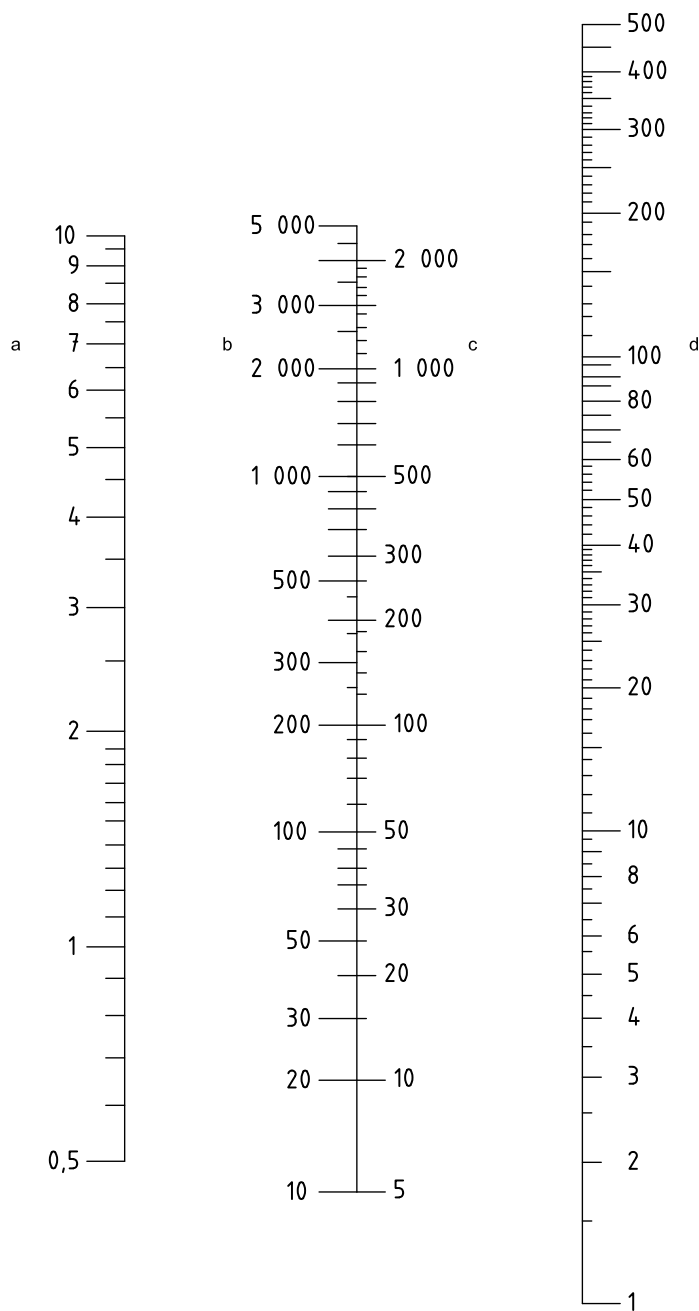

- a Effective focal spot size,  $d$ , in millimetres.
- b Minimum source-to-weld distance,  $f$ , for class B, in millimetres.
- c Minimum source to weld distance,  $f$ , for class A, in millimetres.
- d Weld-to-film distance,  $b$ , in millimetres.

**Figure 1 — Nomogram for determination of minimum source-to-weld distance,  $f$ , in relation to weld-to-film distance,  $b$ , and the effective focal spot size,  $d$**

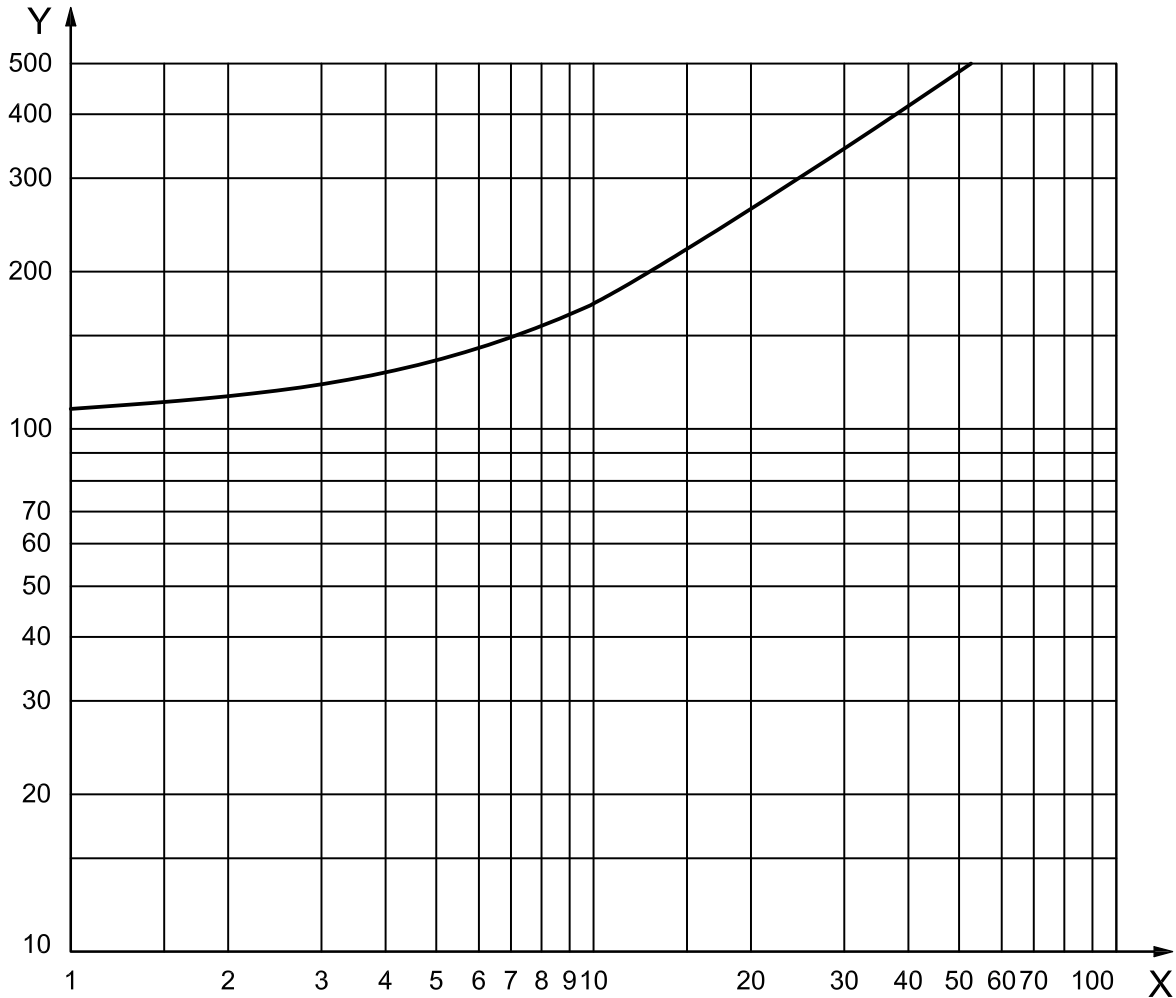

**Key**

- X penetrated thickness, in millimetres
- Y X-ray voltage, in kilovolts

**Figure 2 — Maximum X-ray voltage for X-ray devices up to 500 kV as a function of penetrated thickness**

**6 Image quality**

**6.1** The image quality shall be determined by the use of a mild steel image quality indicator (IQI) of the type specified in ISO 19232-1 or ISO 19232-2, and agreed on between the purchaser and the manufacturer. The IQI shall be placed on the surface facing the source of radiation, on the parent material adjacent to the weld (see Figures 3 and 4).

The IQI shall only be placed on the film side when the surface facing the radiation source is inaccessible. In these circumstances, a letter “F” shall be placed near the IQI and this procedural change recorded in the test report.

NOTE For further details, see ISO 19232-1, ISO 19232-2 and ISO 17636.

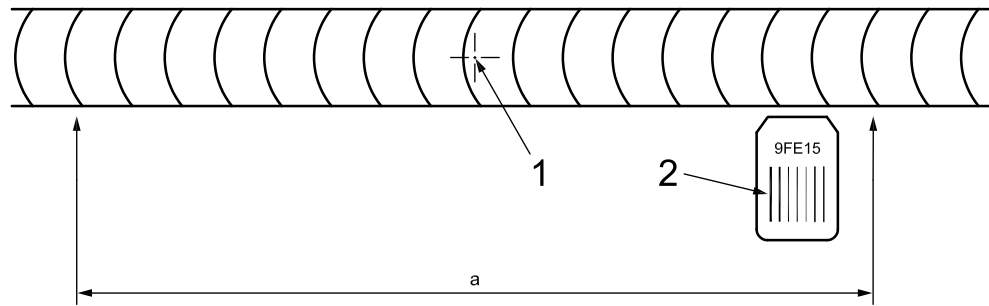

a) Wire type

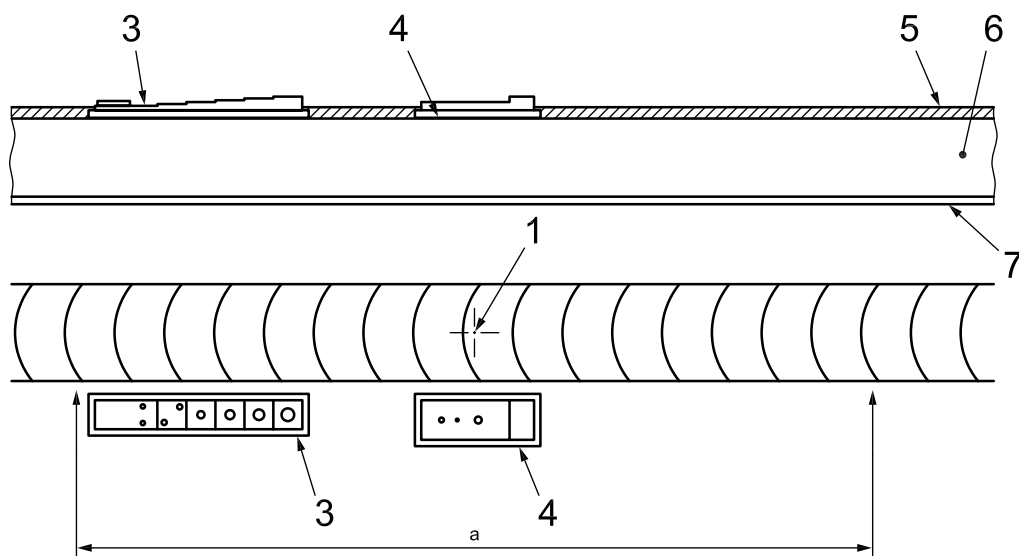

b) Plaque and step/hole types

**Key**

- 1 centre of beam
  - 2 wire type IQI, thinnest wire away from the centre of the beam
  - 3 step/hole type IQI, thinnest step away from the centre of the beam
  - 4 plaque type IQI with shim stock
  - 5 outer weld reinforcement
  - 6 tube wall
  - 7 inner weld reinforcement
- a Diagnostic length.

**Figure 3 — Positioning of IQIs (basic requirements) and the use of shim stock for packing**

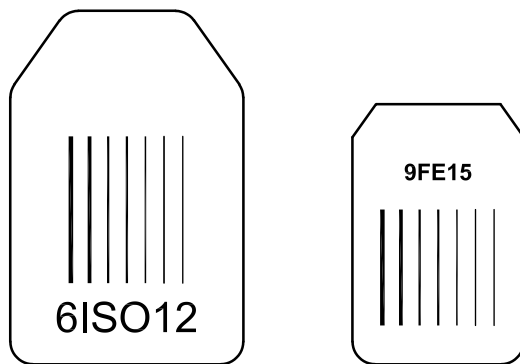

a) Wire type

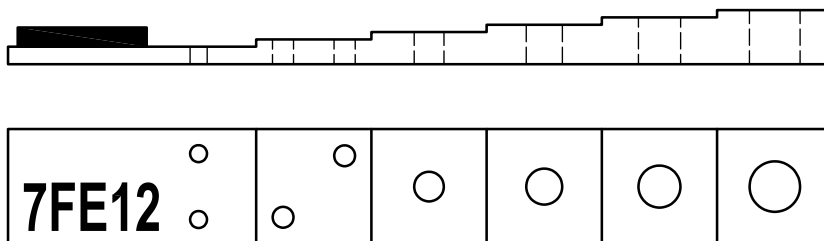

b) Step/hole type

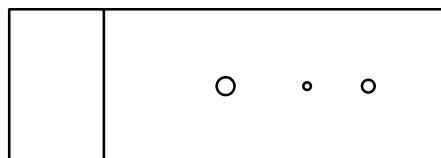

c) Plaque type

Figure 4 — Types of image quality indicator

6.2 The two image quality classes are defined in Tables 1 to 4.

Table 1 — Wire IQI

Image quality class A	
Specified thickness, $T$ mm	IQI value
$T \leq 1,2$	W 18
$1,2 < T \leq 2$	W 17
$2 < T \leq 3,5$	W 16
$3,5 < T \leq 5$	W 15
$5 < T \leq 7$	W 14
$7 < T \leq 10$	W 13
$10 < T \leq 15$	W 12
$15 < T \leq 25$	W 11
$25 < T \leq 32$	W 10
$32 < T \leq 40$	W 9
$40 < T \leq 55$	W 8
$55 < T \leq 85$	W 7
$85 < T \leq 150$	W 6
$150 < T \leq 250$	W 5
$250 < T$	W 4

Table 2 — Step/hole IQI

Image quality class A	
Specified thickness, $T$ mm	IQI value
$T \leq 2$	H 3
$2,0 < T \leq 3,5$	H 4
$3,5 < T \leq 6$	H 5
$6 < T \leq 10$	H 6
$10 < T \leq 15$	H 7
$15 < T \leq 24$	H 8
$24 < T \leq 30$	H 9
$30 < T \leq 40$	H 10
$40 < T \leq 60$	H 11
$60 < T \leq 100$	H 12
$100 < T \leq 150$	H 13
$150 < T \leq 200$	H 14
$200 < T \leq 250$	H 15
$250 < T \leq 320$	H 16
$320 < T \leq 400$	H 17
$400 < T$	H 18

Table 3 — Wire IQI

Image quality class B	
Specified thickness, <i>T</i> mm	IQI value
$T \leq 1,5$	W 19
$1,5 < T \leq 2,5$	W 18
$2,5 < T \leq 4$	W 17
$4 < T \leq 6$	W 16
$6 < T \leq 8$	W 15
$8 < T \leq 12$	W 14
$12 < T \leq 20$	W 13
$20 < T \leq 30$	W 12
$30 < T \leq 35$	W 11
$35 < T \leq 45$	W 10
$45 < T \leq 65$	W 9
$65 < T \leq 120$	W 8
$120 < T \leq 200$	W 7
$200 < T \leq 350$	W 6
$350 < T$	W 5

Table 4 — Step/hole IQI

Image quality class B	
Specified thickness, <i>T</i> mm	IQI value
$T \leq 2,5$	H 2
$2,5 < T \leq 4$	H 3
$4 < T \leq 8$	H 4
$8 < T \leq 12$	H 5
$12 < T \leq 20$	H 6
$20 < T \leq 30$	H 7
$30 < T \leq 40$	H 8
$40 < T \leq 60$	H 9
$60 < T \leq 80$	H 10
$80 < T \leq 100$	H 11
$100 < T \leq 150$	H 12
$150 < T \leq 200$	H 13
$200 < T \leq 250$	H 14

6.3 For the double wall penetration technique, the image quality value that shall be used shall be taken as that corresponding to twice the specified wall thickness.



## 7 Processing of film

The radiographs shall be free from imperfections due to processing or other defects that could interfere with interpretation.

## 8 Viewing conditions for radiographs

The minimum luminance of the illuminated radiograph shall be 30 cd/m<sup>2</sup> for densities less than or equal to 2,5 and 10 cd/m<sup>2</sup> for densities greater than 2,5.

## 9 Classification of indications

**9.1** All indications found on the radiograph shall be classified as weld imperfections or defects as described in 9.2 and 9.3.

**9.2** Imperfections are discontinuities in the weld seam detectable by the radiographic testing method described in this part of ISO 10893. Imperfections with a size and/or population density which are within the specified acceptance limits are considered to have no practical implications on the intended use of the tubes.

**9.3** Defects are imperfections with a size and/or population density greater than the specified acceptance limits. Defects are considered to adversely affect or limit the intended use of the tubes.

## 10 Acceptance limits

**10.1** Acceptance limits are applicable to radiographic examination of the weld seam and specified in 10.2 to 10.6, unless alternative requirements are specified in the product standards.

**10.2** Cracks, incomplete penetration and lack of fusion are not acceptable.

**10.3** Individual circular slag inclusions and gas pockets up to 3,0 mm or  $T/3$  in diameter ( $T$  = specified wall thickness), whichever is the smaller, are acceptable.

The sum of the diameters of all such permitted individual imperfections in any 150 mm or  $12T$  of weld length, whichever is the smaller, shall not exceed 6,0 mm or  $0,5T$ , whichever is the smaller, where the separation between individual inclusions is less than  $4T$ .

**10.4** Individual elongated slag inclusions up to 12,0 mm or  $T$  in length, whichever is the smaller, or up to 1,5 mm in width are acceptable.

The accumulated length of such permitted individual imperfections in any 150 mm or  $12T$  of weld length, whichever is the smaller, shall not exceed 12,0 mm where the separation between individual inclusions is less than  $4T$ .

NOTE For information, the criteria specified in 10.3 and 10.4 are shown diagrammatically in Annex A.

**10.5** Individual undercuts of any length having a maximum depth of 0,4 mm and not encroaching on the minimum wall thickness are acceptable.

Individual undercuts of a maximum length of  $T/2$  having a maximum depth of 0,5 mm and not exceeding 10 % of the specified wall thickness are acceptable, provided there are not more than two such undercuts in any 300 mm of the weld length, and all such undercuts are dressed out.

**10.6** Undercuts on the inside and outside welds which are coincident in the longitudinal direction are not acceptable.

## 11 Acceptance

**11.1** Any tubes not showing indications in excess of that permitted by the corresponding acceptance limits shall be deemed to have passed the test.

**11.2** Any tubes showing indications in excess of that permitted by the corresponding acceptance limits shall be deemed suspect.

**11.3** For suspect tubes, one or more of the following actions shall be taken, subject to the requirements of the product standard:

- a) the suspect area shall be removed by dressing. Complete removal of the defect shall be verified by either liquid penetrant or magnetic particle testing, and the dressed area shall be retested by radiography. The remaining wall thickness shall be measured by an appropriate technique to verify compliance with the specified tolerances;
- b) the suspect area shall be repaired by welding carried out to an approved welding procedure. The repaired area shall then be subject to radiographic examination in accordance with the requirements of this part of ISO 10893 and the product standard;
- c) the suspect area shall be cropped off. The remaining length of the tube shall be measured to verify compliance with the specified tolerances;
- d) the tube shall be rejected.

## 12 Test report

If specified, the manufacturer shall submit to the purchaser a test report including at least the following information:

- a) reference to this part of ISO 10893, i.e. ISO 10893-6;
- b) statement of conformity;
- c) any deviation, by agreement or otherwise, from the procedures specified;
- d) product designation by steel grade and size;
- e) radiation source, type and effective focal spot size and equipment used;
- f) selected film systems, screens and filters;
- g) tube voltage and current;
- h) time of exposure and source-to-film distance;
- i) type and position of image quality indicator (IQI);
- j) IQI reading and minimum film density;
- k) the image quality class achieved;
- l) date of exposure and report;
- m) operator identification and name, certification and signature of the responsible persons.

## Annex A (informative)

### Examples of distribution of imperfections

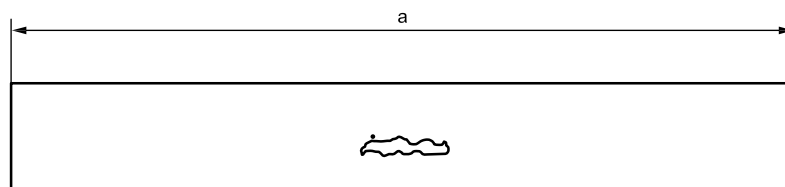

**a) Example 1: one 12,0 mm imperfection**

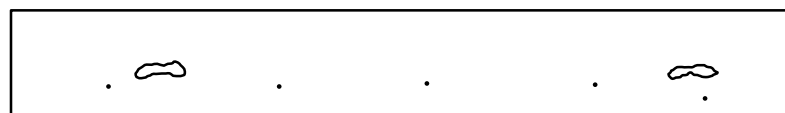

**b) Example 2: two 6,0 mm imperfections**

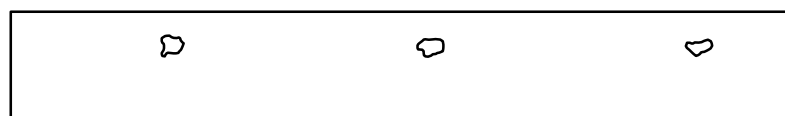

**c) Example 3: three 4,0 mm imperfections**

<sup>a</sup> Weld length 150 mm or 12  $T$  ( $T$  = specified thickness) whichever is the smaller.

**Figure A.1 — Example of maximum distribution patterns of indicated elongated slag imperfections for specified wall thickness above 12 mm**

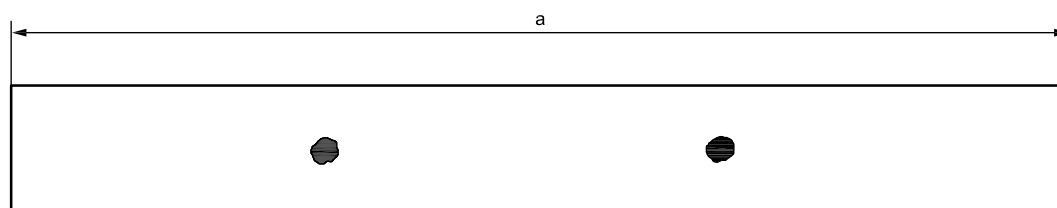

**a) Example 1: two 3,0 mm imperfections**

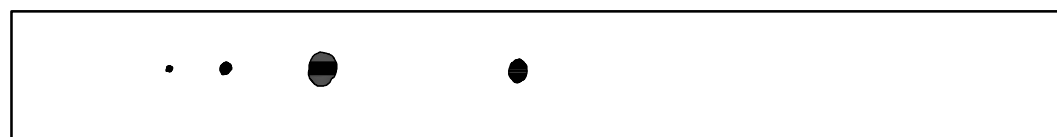

**b) Example 2: one 3,0 mm, one 1,5 mm, one 1,0 mm and one 0,5 mm imperfections**

**Figure A.2 (continued)**

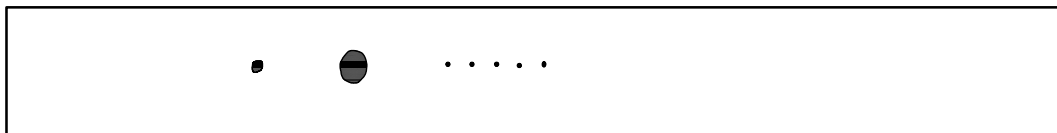

**Example 3: one 3,0 mm, one 1,0 mm and five 0,5 mm imperfections**

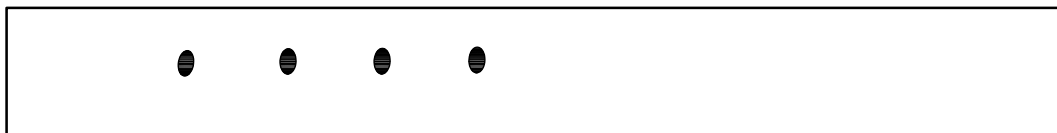

**Example 4: four 1,5 mm imperfections**

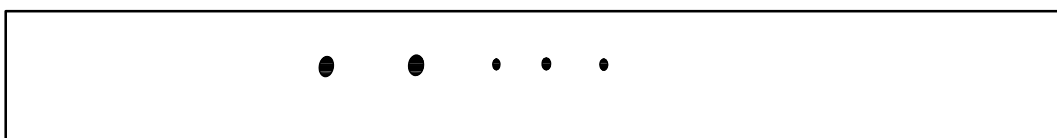

**Example 5: two 1,5 mm, three 1,0 mm imperfections**

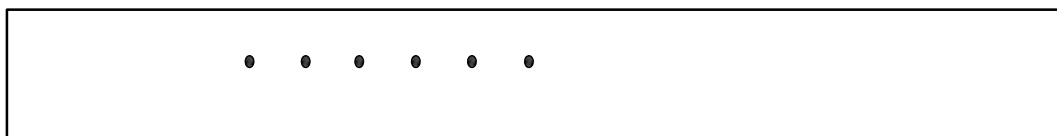

**Example 6: six 1,0 mm imperfections**

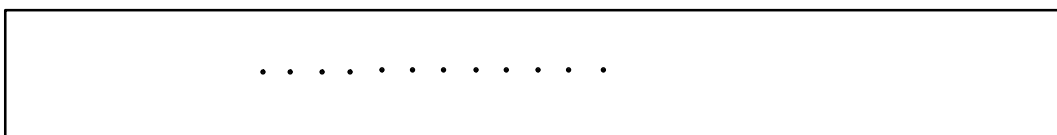

**Example 7: twelve 0,5 mm imperfections**

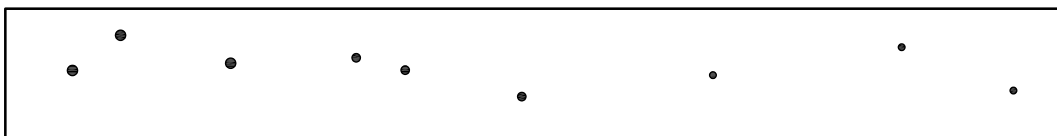

**Example 8: three 1,0 mm, six 0,5 mm imperfections (scattered)**

<sup>a</sup> Weld length 150 mm or 12  $T$  ( $T$  = specified thickness) whichever is the smaller.

**Figure A.2 — Examples of maximum distribution patterns of gas pocket type imperfections for specified wall thickness above 9 mm**

Copyright International Organization for Standardization

---

---

**ICS 23.040.10; 77.040.20; 77.140.75**

Price based on 14 pages