



## Developing Professionals for the Lifting Equipment Industry

# Foundation Course

## Step Notes

## LEEA Learning and Development Agreement

In the interests of all parties and to ensure the successful completion of the LEEA Academy Foundation Course, the following arrangements are to be confirmed:

### Student:

I agree to:

- Follow the instructions of my LEEA training facilitator at all times
- Follow all rules and procedures regarding health and safety matters whilst on site
- Respect the tidiness and cleanliness of training areas and rest area facilities
- Notify my LEEA training facilitator immediately if I have any concerns
- Inform my LEEA training facilitator of any learning difficulties at the soonest opportunity (this may be done privately between you and your LEEA training facilitator)
- Keep to agreed session times and return from rest breaks and lunchtime periods in a timely fashion
- Keep my mobile phone on 'silent' for the duration of all training sessions and to leave the class if I have to make or receive an urgent call, for the benefit of my fellow students
- Provide feedback to the LEEA facilitator regarding the training I have received
- Respect the opinions of my fellow students and to actively engage in group discussion
- Strictly adhere to the rules regarding LEEA Assessments

Signed \_\_\_\_\_

Date \_\_\_\_\_

4

### LEEA Training Facilitator

I agree to:

- Safeguard the health, safety and welfare of my students throughout the training programme
- Provide my students with quality training, maintaining the highest of professional standards throughout
- Maintain confidentiality for all students at all times
- Provide regular feedback to students on their progress, identifying areas which may need additional study
- Keep appropriate records of any assessments conducted
- Ensure that all students are able to discuss any issues or concerns which may arise during the training course

Signed \_\_\_\_\_

Date \_\_\_\_\_

## Disclaimer

These Step Notes are a useful and authoritative source of information for the LEEA Academy Foundation Course student.

Whilst every effort has been made to achieve the highest degree of accuracy in the generation of the data and information supplied, ultimate responsibility remains with the student and their employer to ensure that current legal requirements are followed.

**First Edition.....August 2017**

© LEEA 2016. All rights reserved. No part of this publication may be reproduced, stored in a retrieval system or transmitted in any form or by any means, without the prior written permission of the Lifting Equipment Engineers Association.

## Training

**Operative training for all the equipment covered in these step notes should always take the manufacturer's information and instructions for use into account.**



## Digital Navigation

If you are viewing this document electronically, you can navigate using the Contents table above.

Click the heading to jump to that module.

To return to the Contents, click the  at top of each page.

## CONTENTS

Contents.....	6	14. Textile Webbing Slings .....	102
1. Legislation .....	7	15. Textile Roundslings.....	109
2. Standards and Codes of Practice.....	22	16. Components for Slings .....	115
3. Materials .....	26	17. Shackles and Eyebolts .....	121
4. Basic Heat Treatment.....	34	18. Turnbuckles .....	131
5. Units of Measure.....	36	19. Manual Chain Hoists.....	133
6. Basic Force, Stress and Strain.....	38	20. Lever Hoists .....	138
7. Basic Mechanics of Simple Machines.....	43	21. Jaw Winches .....	142
8. Methods of Manufacture .....	48	22. Jacks.....	145
9. Verification of Lifting Equipment .....	56	23. Crane Forks and C Hooks.....	149
10. Rating and Marking of Lifting Equipment .	63	24. Powered Lifting Machines.....	151
11. Wire Rope and Wire Rope Slings.....	71	25. Runways and Crane Structures .....	157
12. Chain and Chain Slings .....	88	26. Overhead Travelling Cranes .....	162
13. Textile Slings – Fibre Rope and Fibre Rope Slings .....	96	27. Offshore Containers .....	165
		28. Mobile Cranes .....	169

# 1. LEGISLATION

## Moral, Legal and Financial Reasons for Health and Safety Legislation

Employers have a moral responsibility to ensure appropriate working conditions are provided. This is known as a common law duty of care.

Unsafe working conditions are likely to have an impact on production

- Loss of output leading to lowering of morale and motivation
- Loss of sales turnover and profitability

Society and customer expectations of a company's approach to managing safety - health and safety culture  
Negative public relations would have a damaging effect on any business

Financial cost from loss of output:

- Fines
- Damages
- Legal costs
- Insurance
- Etc.

## The Legislative Framework

7

### Health and Safety at Work etc. Act 1974 (UK)

- The act is general in nature
- There is no reference to specific articles or substances
- The act applies to all sectors

Specific duties of care for:

- Manufacturers/suppliers of articles or substances
- Employers
- Employees

The health and safety at work act (HSWA) is an enabling act for specific regulations

**Status in UK:** legal requirement.

**International:** adopted as best practise, and requested by LEEA member companies.

Notes:

## Legislative Structure of Health and Safety

- Primary legislation sets out governing principles
- Establishes an agency to enforce them, e.g. the HSE in the UK
- Subordinate legislation or regulations deal with particular industries and associated codes of practice - clarifying the standards to which entities must work

In the UK the Health and Safety at Work etc. Act 1974 is supported by LOLER and PUWER Regulations 1998 and their respective Approved Codes of Practice (L113 LOLER, L22 PUWER)

## The Main Purposes of the HSWA

The Health and Safety at Work Act covers nearly all occupations. It is designed to protect people at work including staff, visitors, contractors and members of the public. The HSWA supersedes nearly all of the previous health and safety laws in the UK.

The main purposes of the Act are set out in section 1 as follows:

- To secure the health, safety and welfare of persons at work
- To protect other people from hazards arising from work
- To control the keeping and use of dangerous substances and materials, including explosives and highly flammable materials
- To control the emission of noxious substances from certain premises

8

It sets out a framework of general duties, primarily on employers, but also on employees and the controllers of premises, and on designers, manufacturers, importers and suppliers in relation to articles and substances used at work.

## Regulations from the HSWA

Regulations are one form of delegated legislation made possible by section 15 of HSWA which gives powers to the secretary of state (UK) to make regulations for matters concerned with health and safety at work.

Regulations are not acts of Parliament but do have the support of the law and therefore must be complied with.

Regulations are increasingly drafted by reference to European Directives (these will be discussed at a later stage in this module).

There are many sets of regulations applying to health and safety. Some apply to all places of work and others are specific to particular industries, operations, substances, materials or premises.

Here are a couple examples of such regulations:

- The Manual Handling Operations Regulations 1992
- The Control of Substances Hazardous to Health Regulations 2002

## Health and Safety at Work Act Section 2

### Duties of the Employer

“Duty to ensure so far as is reasonably practicable, the health, safety and welfare at work of all his/her employees”

- Safe plant and systems of work
- Safe use, handling, storage and transportation of articles and substances
- Information, instruction, training and adequate supervision
- Safe place of work and a safe means of access and egress
- Safe working environment and adequate welfare facilities

9

## Health and Safety at Work Act Section 6

### Duties of Designers, Manufacturers, Importers and Suppliers

- To ensure, so far as is reasonably practicable, that articles they design, construct, make, import, supply etc. are safe and without risk to health at all times e.g. when it is being set up, cleaned, used or maintained by someone at work
- To carry out or arrange such testing and examination necessary to perform the duties above
- To ensure that those supplying the item have adequate information about its designed and tested use. This includes essential conditions for dismantling and disposal
- Take steps to ensure, so far as is reasonably practicable, that those supplied are given updated information where it becomes known that the item gives rise to serious risk to health and safety

Notes:

## Health and Safety at Work Act Section 7

### Duties of the Employees

- States that employees must not endanger themselves, or others, by their acts or omissions
- Also, they must co-operate with their employers; as long as this does not lead to an increased risk to health and safety, or is an illegal act; so that employers can comply with their statutory duties

**This makes responsibility for safety a joint employer/employee effort**

## The European Machinery Directive

### Machinery Directive 2006/42/EC

A European Directive is a Directive to the member states of the European Community, which has been adopted by the Council of Ministers, to introduce legislation with common requirements throughout the Community. The Directives are used to remove barriers to trade and introduce common safety requirements.

The Machinery Directive is largely based on Risk Assessment and use of EU Standards for critical features such as guards and emergency stops.

The Machinery Directive is implemented by the Supply of Machinery (Safety) Regulations in the UK. This regulation only applies to the manufacturer if he is based in the EEA (European Economic Area), or the initial importer into the EEA if the manufacturer is based outside.

10

## Supply of Machinery (Safety) Regulations 2008 – SM(S)R

The Supply of Machinery (Safety) Regulations 2008, SI No 1597 implement the Machinery Directive and contain essential safety requirements which the machinery, including lifting machines and lifting accessories, must meet. Manufacturers, importers (into the European Union) and suppliers placing such equipment on the market for service in the community have a duty to:

- Design, build and supply equipment that is safe and meets the Essential Safety Requirements
- Carry out such tests as may be necessary to ensure the requirements of the above are met
- Maintain records of all calculations, tests and other relevant information that go to make up a Technical File which may be called upon by the enforcing authorities and which must demonstrate that the Essential Safety Requirements have been met
- Issue with each item of equipment information on the installation, maintenance, care and safe use; and issue a Declaration of Conformity and affix the CE mark, or issue a Declaration of Incorporation depending on its nature and intended use. In this context, if you manufacture or import (from outside the European Union) an item for your own use, you assume the full responsibilities of the manufacturer and must therefore meet all of the requirements of the Regulations

To support the Machinery Directive, the Joint European Standards Organisation, CEN/CENELEC, has been producing Harmonised European Standards.

Most of these standards have been published but there are still some left in the pipeline. As and when they are published, they will supersede any existing British Standards or other European national standards covering the same products.

These Harmonised Standards have a special status in that products made to the standard are deemed to meet the essential health and safety requirements of the relevant Directives, and therefore the UK Regulations, in so far as the standard addresses such essential requirements.

They therefore provide a relatively easy way for manufacturers to know that their products meet the legal requirements and equally a convenient way for purchasers to specify their needs.

Following the publication of the new Machinery Directive 2006/42/EC in 2006, all the relevant Harmonised Standards have been amended to make reference to it.

### **The Technical File**

- May contain drawings, calculations, Q.C procedures, copy of instructions, results of tests (prototype or routine)
- The file need not exist in hard copy, but needs to be able to be assembled in a reasonable time

### **What is a “Machine”?**

- An assembly of linked parts, or components, at least one of which moves
- An assembly of machines
- Interchangeable equipment modifying the function of a machine
- This means that all lifting Equipment can be described as a machine and therefore comes under these regulations

Notes:

## Definitions of Terms Used

### Lifting Equipment

Used in two different ways in LOLER:

1. A generic term used to cover all lifting accessories and appliances
2. A more specific meaning covering lifting appliances, their anchorages and fixings

### Lifting Accessories

Any device such as a sling, eyebolt, spreader beam etc. used to connect the load to a lifting appliance but which is not itself part of the load or the appliance.

### Lifting Machine/Lifting Appliance

A device or mechanism, such as a winch, sheave block or chain block, which does the work in lifting the load or provides the means of movement, or:

The supporting structure and anchoring devices for such a mechanism, e.g. runway, which may also permit a suspended load to be moved in the horizontal plane.

### Coefficient of Utilisation (CoU), Factor of Safety (FOS), Working Coefficient

It is a factor which is applied to the MBL to determine the WLL. It varies with the product to take account of the susceptibility to damage and considers the type of stresses the item will meet in normal use.

### Mode Factor

A factor applied by the user (slinger or rigger) that takes into account the geometry of a sling assembly to obtain the maximum load it may lift for a particular mode of use.

12

### Working Load Limit

WLL (sometimes called maximum SWL)

The maximum load or mass that an item of lifting equipment is designed to sustain, i.e. raise, lower or suspend. This is the load required to be marked on an item by the product standards.

### Safe Working Load (SWL)

The maximum load or mass (as certified by a competent person) that an item of lifting equipment may raise, lower or suspend under particular service conditions. It is the SWL which is required to be marked on the item by LOLER and which appears on any report of thorough examination.

**Note:** The SWL will normally be the same value as the WLL or the maximum safe working load but it may be less.

### The Minimum Breaking (or failure) Load (MBL)

The minimum breaking load is the calculated load at below which the item will not break or fail due to distortion.

## Supply of Machinery (Safety) Regulations 2008

Lifting Equipment must be designed and built to sustain a static overload.

Manually operated machines	1.5 x WLL
Other machines	1.25 x WLL
Lifting accessories	1.5 x WLL

Machinery must be capable of sustaining a dynamic overload of :-

$$1.1 \times \text{WLL}$$

Previous standards and directives have used different values therefore it is important to always consult manufacturers documentation for specific requirements

Lifting machines must also be supplied with instructions for :-

- Care and safe use
- Installation, commissioning and testing
- Maintenance and adjustments
- Limitations of use and possible misuse
- Noise and vibration emissions
- Training

Notes:



## Management of Health and Safety at Work Regulations 1992 (Revised 1999)

In addition to section 2 (2) c of the HSWA, the **Management of Health and Safety at Work Regulations 1999** (MHSWR) require employers to ensure the effective planning, organisation, control, monitoring and review of preventive and protective measures. All these arrangements must be recorded and made known to employees. This is usually accomplished by the design of a company health and safety policy.

- MHSWR underlines the requirements for employers to provide instruction and training
- Employers must ensure that their personnel are properly trained to use any equipment necessary in the course of their work, but the regulations also place an obligation on employees to undergo such training and follow the instructions given by their employer
- Operatives are required to only use equipment for which they are trained and to use it in the manner and for the purpose for which they have been trained

### LEEA Definition of a Competent Person

The term 'Competent Person' has long been used in legislation. Current legislation uses it for a variety of duties to describe a person with the necessary knowledge, experience, training, skill and ability to perform the specific duty to which the requirement refers. There can therefore be several 'Competent Persons', each with their own duties and responsibilities, i.e. competent for the purpose.

The term has never been fully defined in law but, for the purpose of thoroughly examining lifting equipment, the LEEA definition of a Competent Person is a person having such practical and theoretical knowledge and experience of the equipment which is to be thoroughly examined that will enable him/her to detect defects or weaknesses which it is the purpose of the examination to discover and assess their importance to the safety of the equipment.

The Competent Person should have the maturity to seek such specialist advice and assistance as may be required to enable him/her to make necessary judgements and be a sound judge of the extent to which he/she can accept the supporting opinions of other specialists. He/she must be able to certify with confidence whether it is free from patent defect and suitable in every way for the duty for which the equipment is required. It is the view of LEEA that competency can be a corporate responsibility.

### Primary Elements of Competency

Information

Instruction

Training

Supervision

**Note:** LEEA Foundation Course and Advanced Programme certificates are not evidence, declaration or proof of competency.

## What are the Required Elements of Competency?



15

Only Use Equipment in the Manner You Have Been Trained to Use it...



Notes:

## PUWER and LOLER

**PUWER:** Provision and Use of Work Equipment Regulations 1998 applies to all work equipment

**LOLER:** Lifting Operations and Lifting Equipment Regulations 1998 applies to lifting equipment in addition to PUWER

Both LOLER and PUWER apply to all sectors of industry

### Status of PUWER and LOLER

United Kingdom: Legal requirement

International: Good practice demanded customers and local authorities, integral to the LEEA Code of Practice



ACoPs L113 (LOLER) and L22 (PUWER) are available as a free pdf download at: [www.hse.gov.uk](http://www.hse.gov.uk)

## Provision and Use of Work Equipment Regulations (PUWER)

<b>Regulation 4</b>	<b>Suitability of Work Equipment</b>
<b>Regulation 5</b>	<b>Maintenance</b>
<b>Regulation 6</b>	<b>Inspection</b>
<b>Regulation 7</b>	<b>Specific Risks</b>
<b>Regulation 8</b>	<b>Information and Instructions</b>
<b>Regulation 9</b>	<b>Training</b>

These regulations apply to all equipment which is used by an employee at work and must be complied with even though more specific regulations may apply.

- Contains requirements for maintenance (Regulation 5)
- Equipment entering work place must comply with relevant directives

Regulations require that equipment provided for use at work is:

- Suitable for the intended use
- Safe for use, maintained in a safe condition and, in certain circumstances, inspected to ensure this remains the case
- Used only by people who have received adequate information, instruction and training
- Accompanied by suitable safety measures, e.g. protective devices, markings and warnings

## Summary of the Key Requirements of PUWER

PUWER requires employer to address risks or hazards of equipment from all dates of manufacture and supply.

Equipment first provided for use after 31st December 1992 must comply with any 'essential requirements'

Equipment may still present a hazard or risk if: application different from that originally envisaged; safety depends upon the way it is installed; technical mismatch between the supply side and user side legislation

How does an employer check that equipment he has purchased complies with the requirements of PUWER?

- Locate the CE marking
- Obtain the EC declaration of conformity from the supplier

## Lifting Operations and Lifting Equipment Regulations (LOLER)

<b>Regulation 4</b>	<b>Strength and Stability</b>
<b>Regulation 5</b>	<b>Lifting Equipment for Lifting Persons</b>
<b>Regulation 6</b>	<b>Positioning and Installation</b>
<b>Regulation 7</b>	<b>Marking of Lifting Equipment</b>
<b>Regulation 8</b>	<b>Organisation of Lifting Operations</b>
<b>Regulation 9</b>	<b>Thorough Examination and Inspection</b>
<b>Regulation 10</b>	<b>Reports and Defects</b>
<b>Regulation 11</b>	<b>Keeping of Information</b>

Notes:

**Regulation 4                      Strength and Stability**

Requires the employer to ensure that the load they are planning to lift does not exceed the limits for strength and stability of the lifting equipment.

**Regulation 5                      Lifting Equipment for Lifting Persons**

Details the additional safeguards that must be considered when using lifting equipment to lift people.

**Regulation 6                      Positioning and Installation**

Details the considerations on where lifting equipment, both fixed and mobile equipment, should be sited.

**Regulation 7                      Marking of Lifting Equipment**

Requires all lifting equipment to be marked with its SWL and information that gives the items characteristics, e.g. grade, angle of use etc.

**Regulation 8                      Organisation of Lifting Operations**

Clarifies that each lifting operation needs to be planned, supervised and carried out safely.

**Regulation 9                      Thorough Examination and Inspection**

Every employer shall ensure that before lifting equipment is put into service for the first time by him it is thoroughly examined for any defect unless the lifting equipment has not been used before; and, in the case of lifting equipment for which an EC Declaration of Conformity should have been drawn up, the employer has received such declaration made not more than 12 months before the lifting equipment is put into service.

Maximum fixed periods for thorough examinations and inspection of lifting equipment as stated in regulation 9 of LOLER are: -

Lifting Accessories	6 months
Lifting Equipment	12 months
Man-Riding Equipment	6 months

The information to be contained in the report of thorough examination is given in **schedule 1 of LOLER**.

Notes:

## **Regulation 10                      Reports and Defects**

A person making a thorough examination for an employer under regulation 9 shall:

- Notify the employer forthwith of any defect in the lifting equipment which in his opinion is or could become a danger to persons
- As soon as is practicable make a report of the thorough examination in writing authenticated by him/her or on his/her behalf by signature or equally secure means and containing the information specified in schedule 1 to the employer; and where there is in his opinion a defect in the lifting equipment involving an existing or imminent risk of serious personal injury, send a copy of the report as soon as is practicable to the relevant enforcing authority

Where there is in his opinion a defect in the lifting equipment involving an existing or imminent risk of serious personal injury, the Competent Person will send a copy of the report as soon as is possible to the relevant enforcing authority. In this case, an employer who has been notified of an imminent risk shall ensure that the lifting equipment is not used before the defect is rectified.

## **Regulation 11                      Keeping of Information**

Where an employer obtaining lifting equipment to which these Regulations apply receives an EC declaration of conformity relating to it, he shall keep the declaration for so long as he operates the lifting equipment.

The employer shall ensure that the information contained in –

- Every report made to him under regulation 10(1)(b) is kept available for inspection
  - i. In the case of a thorough examination under paragraph (1) of regulation 9 of lifting equipment other than an accessory for lifting, until he ceases to use the lifting equipment;
  - ii. In the case of a thorough examination under paragraph (1) of regulation 9 of an accessory for lifting, for two years after the report is made;

## **Manual Handling Operations Regulations 1992**

- Refers directly to lifting operations and adds to the employer's duties in Section 2 of the HSWA
- Requires an assessment to be made of any operation where loads are handled manually, or where manual effort is necessary, with a view to reducing the number of injuries that result from such operations:
  - Task
  - Individual
  - Load
  - Environment
- Requires the introduction of lifting appliances where the risks are high or if the operation can be made safer by their introduction

## Electromagnetic Compatibility Regulations 2006

- Another European Directive with which electrically operated lifting equipment must comply - the European Electromagnetic Compatibility Directive
- These regulations are concerned with the emission of, and susceptibility to, interference
- Manufacturers must build their equipment in such a way that it does not cause interference with other electrical equipment and so that it is not subject to the effects of interference emitted by other equipment. They must conduct any tests necessary to ensure that this is the case
- Whilst this is not a matter for the tester and examiner of lifting equipment, we should note that when the manufacturer affixes the CE mark to an item it implies that all the necessary directives have been complied with. The EC Declaration of Conformity for electrically operated lifting equipment should therefore refer to both the Machinery Directive and the Electromagnetic Compatibility Directive

## Working at Height

The danger of people and materials falling affects not only those working at height, but also, and sometimes to a greater degree, those underneath.

Working at height is one of the biggest causes of fatalities and major injuries. Commonly, accidents are caused from falls from ladders and through fragile surfaces. Work at height means work in any place where, if there were no precautions in place, a person could fall a distance that could cause personal injury (for example a fall through a fragile roof).

20

Employers and those in control of work at height must first assess the risks.

### Before working at height you must follow these simple steps:

- Avoid work at height where it is reasonably practicable to do so
- Where work at height cannot be easily avoided, prevent falls using either an existing place of work that is already safe or the right type of equipment
- Minimise the distance and consequences of a fall, by using the right type of equipment where the risk cannot be eliminated

## Working at Height Regulations (UK)

The Work at Height Regulations 2005 have an influence on lifting practice.

They emphasise the need to **avoid working at height if possible** but, where it is necessary, they require the most suitable means of reducing and controlling the risk.

Consequently, this has affected the choice of equipment for some lifting operations.

## Dos and Do Nots of Working at Height

### Do:

- As much work as possible from the ground
- Ensure workers can get safely to and from where they work at height
- Ensure equipment is suitable, stable and strong enough for the job, maintained and checked regularly
- Take precautions when working on or near fragile surfaces
- Provide protection from falling objects
- Consider emergency evacuation and rescue procedures

### Do not:

- Overload ladders – consider the equipment or materials workers are carrying before working at height. Check the pictogram or label on the ladder for information
- Overreach on ladders or stepladders
- Rest a ladder against weak upper surfaces, e.g. glazing or plastic gutters
- Use ladders or stepladders for strenuous or heavy tasks, only use them for light work of short duration (a maximum of 30 minutes at a time)
- Let anyone who is not competent (who doesn't have the skills, knowledge and experience to do the job) work at height

## Revoked, Repealed and Amended Legislation

21

Prior to 5 December 1998, the Factories Act 1961 was the main legislation concerned with the use of lifting equipment and it was augmented by several sets of industry specific regulations. The Provision and Use of Work Equipment Regulations 1998 and the Lifting Operations and Lifting Equipment Regulations 1998 together repeal, revoke or amend and replace the requirements for lifting equipment given in the following:

- The Factories Act 1961
- The Construction (Lifting Operations) Regulations 1961
- The Shipbuilding and Ship-repairing Regulations 1960
- The Docks Regulations 1988
- The Mines and Quarries Act 1954
- The Offshore Installations (Operational Safety, Health and Welfare) Regulations 1976
- The Lifting Plant and Equipment (Records of Test and Examination etc.) Regulations 1992

Notes:



## 2. STANDARDS AND CODES OF PRACTICE

### What are Standards?

Standards are a published specification that sets a common language, and contains a technical specification or other precise criteria and is designed to be used consistently, as a rule, a guideline, or a definition.

Standards are applied to many materials, products, methods and services helping to make life simpler and increase the reliability and effectiveness of goods and services.

Standards are designed for voluntary use and do not impose any regulations, but laws may refer to a certain standard making compliance with them compulsory. Examples include:

- ISO Standards (International standard used globally)
- BS (British Standards, used mainly in the UK)
- EN (Euronorm, used throughout Europe)
- ASME (American Standards)
- DIN (German Standards)

### Creating Standards

Standards are usually created by a collective of appropriately experienced and qualified people whom function together as a committee. Details of proposed standards are agreed and a draft of the standard is released for anyone who has an interest in the standard to make comments about the contents. Once the reviews have finished, the standard may be published.



### Harmonised European Standards (Transposed)

For lifting equipment, these standards are made through the European Standards body CEN. The standards bodies of the member states (BSI in the UK) are then required to withdraw any conflicting standards and publish the Harmonised Standard as their national standard. A manufacturer can demonstrate compliance with the requirements of a Directive by working to Harmonised Standards in so far as the standards address the requirements.

CEN standards carry the prefix EN. In practice the standards bodies of the member states publish the standards with the additional prefix used for their national standards, e.g. in the UK they are published with the prefix BS EN and in Germany as DIN EN. The number of the standard and its content is then identical throughout Europe. However not all EN standards are Harmonised and it is necessary to refer to the standard to establish its relationship with Directives.

Transposed Harmonised European Standards, which are intended to remove technical barriers to trade and to be recognised throughout Europe and beyond. They enjoy a quasi-legal status under the European Directives and working to them is the easiest way for a manufacturer to demonstrate compliance with the 'essential safety requirements' addressed by the standard.

## Standards

The LEEA COPSULE (Code of Practice for the Safe Use of Lifting Equipment) aligns itself to, or quotes, Transposed Harmonised European (CEN) Standards, International (ISO) or National (BS) standards where they exist, as the COPSULE working group consider that these standards set a benchmark level of safety and performance in use.

Throughout your training course, references made to standards relate to the current issue in print, unless the date of the standard is fully quoted.

## Codes of Practice

A Code of Practice is a set of written rules which explains how people working in a particular profession should behave, or a set of standards agreed on by a group of professionals who do a particular job.

There are various types of Codes of Practice:

23

- ACoP (Approved Code of Practice)
- RCoP (Recommended Code of Practice)
- A 'trade' or 'professional' Code of Practice
- Technical Publications
- Safety Information Sheets

## Approved Codes of Practice

The Regulations which provide the detailed requirements in respect of the general duties set out in HSWA do not themselves specify how employers and others should meet those requirements. This is the role of the Approved Codes of Practice (ACoPs). They detail how to comply with the legal requirements.

ACoPs are issued by the Health and Safety Executive with the consent of the relevant government minister and following consultation with government departments, employers' and employees' organisations, and expert opinion in the subject area.

There are ACoPs accompanying some of the health and safety regulations and they have a particular significance, in addition to simply providing guidance on how to comply with the requirements of the regulations. This lies in the fact that contravention of the advice in a code of practice is admissible in evidence to prove a breach of the statutory provisions as set out in HSWA itself and the associated regulations.

The introduction to ACoPs contains the following statement:

“Although failure to comply with any provision of the code is not actually an offence, such a failure may be used in criminal proceedings as evidence that a person has contravened a regulation to which the provision relates. In such a case, however, it will be open to that person to satisfy the court that he has complied with the regulation in some other way.”

It is important not to confuse Regulations with Approved Codes of Practice (ACoPs). ACoPs do not state legal requirements and, therefore, you cannot be prosecuted for failing to comply with any guidance contained in them. However, if you do not comply with them, this may be used as evidence of non-compliance with the Regulations, unless you can prove otherwise.

Examples of Approved Codes of Practice are:

ACoP L113 - LOLER ACoP (Lifting Operations and Lifting Equipment Regulations)

ACoP L22 - PUWER ACoP (Provision and Use of Work Equipment Regulations)

## The LEEA COPSULES

COPSULE is a Recommended Code of Practice.

First published in 1981, the Code has expanded in stages as more sections have been added.

The 8th Edition (April 2014) reflects the changes to legislation arising from the new European Machinery Directive which came into force on 29th December 2009 and includes a new section dealing with electric overhead travelling cranes.

COPSULE is a practical guide covering manual and power operated lifting machines and structures, such as jib cranes and mobile gantries, together with a wide range of below hook equipment, from general purpose slings and lifting accessories, to the various types of vacuum and magnetic lifters.

COPSULE is available from LEEA on our website at [www.leeaint.com](http://www.leeaint.com)

### Guidance Notes

Additional guidance on particular Regulations is also provided in Approved Codes of Practice.

The guidance materials from the HSE provide a further source of advice on effective measures which may be taken to meet the requirements of the corresponding Regulation.

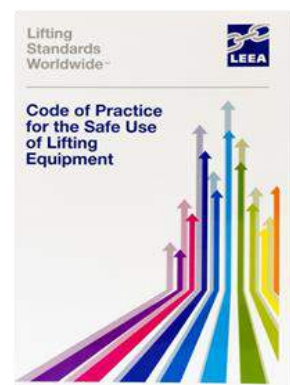

## Summary

As we have already seen in Module 1 (Legislation), the HSWA is an enabling Act. That is, it prescribes general duties only and doesn't say exactly what employers and others are required to do in order to meet those duties.

The detail is provided by the Regulations. These provide exact specifications of what those who have duties under the Act are required to do to. However, whilst they tell you what you have to do, they do not tell you how to do it.

The detail of this is provided by Approved Codes of Practice. These set out exactly how the requirements of the regulations may be complied with. Those responsible under the Act do not have to do things in exactly the way specified by the ACoP but, if they do not, they have to be able to show that the way in which they are operating has the same effect of meeting the requirements.

Notes:

### 3. MATERIALS

The material used in the manufacture of lifting equipment must be:

- Strong
- Capable of resisting shock loads, and therefore ductile
- Hard to resist wear
- Capable of being easily worked by forging, casting or machining
- Sometimes the material has to be capable of being welded
- Able to resist corrosion

#### Material Properties

Lifting equipment requires a balance of physical and chemical properties in order to make it suitable for purpose. We will look at the following properties which are most important:

##### Strength

Strength is a measure of how well a material can resist being deformed from its original shape. Typically, metals are specified for their tensile strength, or their resistance to being pulled apart, but compressive strength is also a legitimate material property describing resistance to being squeezed.

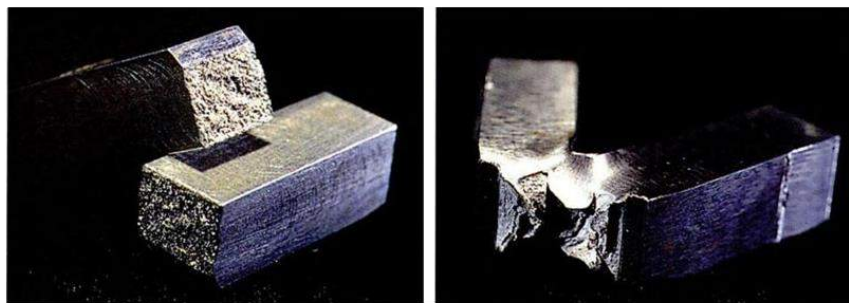

##### Ductility

Ductility is a mechanical property that describes the extent in which solid materials can be plastically deformed under tensile stress without fracture.



##### Malleability

Malleability is similar to ductility but it is a material's ability to deform under compressive stress. A good example of this is the manufacture of wire for wire ropes.

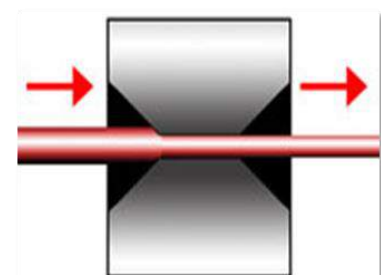

**Brittleness**

Brittleness is the tendency of a material to fracture or fail upon the application of a relatively small amount of force, impact, or shock. Brittleness is the opposite of toughness.



**Elasticity**

The ability of a material to return to its original dimensions after the removal of stress. A good example of this is a spring.



27

**Plasticity**

The ability of a material to retain its new dimensions once stress is removed. A good example of this is a stretched chain link.



**Toughness**

Toughness is the ability of a material to absorb energy and plastically deform without fracturing.

Toughness is the opposite of brittleness.

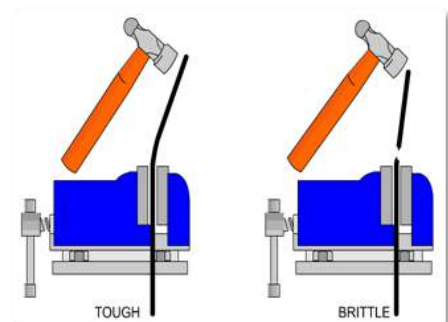

Notes:

### Hardness

Hardness is a measure of how resistant solid matter is to various kinds of permanent shape change when a compressive force is applied.

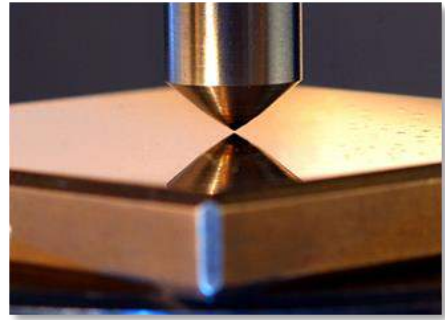

### Corrosion

This is the electrochemical oxidation of metals in reaction with an oxidant such as oxygen. Rusting, the formation of iron oxides, is a well-known example of electrochemical corrosion. This type of damage typically produces oxide(s) or salt(s) of the original metal.



Notes:



## Materials Used for Lifting Equipment

Materials used for the manufacture of lifting equipment are typically grouped into 3 categories:

- Metals
- Polymers
- Natural Products

Metals are the primary group of materials used for lifting equipment manufacture.



## Metals

Metal is made from metal ores, which have to be mined and processed to transform them into usable materials. Pure metals are usually blended with other metals to change their basic properties. A mixture of metals is known as an alloy.

29

There are two types of metals:

- **Ferrous** – ferrous metals include steel and pig iron (with a carbon content of a few percent) and alloys of iron with other metals (such as molybdenum, chromium, nickel etc.)
- **Non-Ferrous** - non-ferrous metal and its alloys do not contain iron in large amounts

The most common type of ferrous metal - known as low carbon steel - is relatively easy to machine, it is fairly tough and inexpensive to produce.

## Iron and Steel

### Iron

Pure iron is soft and easily shaped. Pure iron is too soft for many uses.

Iron from the blast furnace is an alloy of about 96% iron with carbon and some other impurities. It is hard, but too brittle for most uses. So, most iron from the blast furnace is converted into steel by removing some of the carbon.



## Steel

Carbon is removed by blowing oxygen into the molten metal. It reacts with the carbon producing carbon monoxide and carbon dioxide. These escape from the molten metal. Enough oxygen is used to achieve steel with the desired carbon content. Other metals (alloys) are often added, such as vanadium and chromium which would alter the physical properties of the steel, such as toughness, ductility and hardness.

### Carbon Steel

There are three classes of carbon steels are used in various ways in the manufacture of lifting equipment:

- Low carbon steels – known as mild steels
- Medium carbon steels – known as higher tensile steels
- High carbon steels – known as high tensile steels

The quantity of carbon present will affect the tensile strength, with the form and distribution of the carbon affecting the mechanical properties. Typical amounts are 0.25% -0.33% for Higher Tensile Steel

Mild steel is considered unsuitable for use in the manufacture of lifting gear, i.e. chains and fittings. It is however used to fabricated items, such as grabs, trolleys, spreaders etc.

Mild steel is recognisable by a grade mark of 3 or, more usually, no mark at all.

### Higher Tensile Steel

Manufacture chain and fittings resulting in a product one-third stronger than mild steel and recognised by grade marks 4, 04 or M. (Eyebolts are still produced at this grade)

30

### High Tensile Steel

High tensile steel has limited use in lifting equipment. It's hard wearing properties make it suitable for use as components such as drive shafts, wheel axles and sheave pins.

### Alloy Steel

The properties of a metal are changed by including other elements, such as carbon.

Steel is an alloy of iron and small amounts of carbon. Its mechanical properties can be varied depending on the required use.

Alloy steel contains a quantity of some other metal alloyed with the iron, usually chromium, nickel, manganese, tungsten, or vanadium. Its characteristics are altered by the addition of these elements.

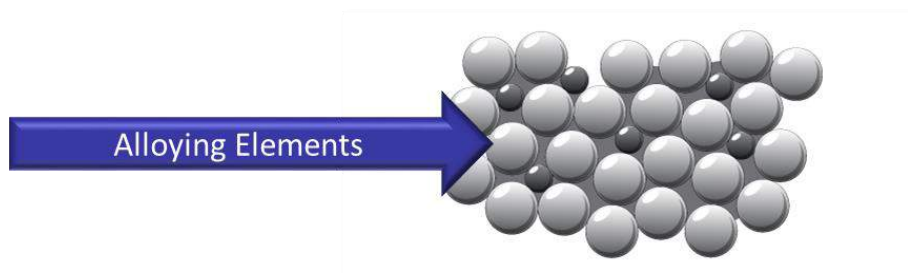

Alloys contain atoms of different sizes, which distort the regular arrangements of atoms. This results in a stiffer molecular structure so the atoms cannot move so easily.

## Other Alloys

### Copper and its Alloys

Ferrules for use on stainless steel wire ropes and tubing for oil systems are two good examples. Copper is a good electrical conductor; it is used for electric cables, power supply system's etc.

### Brass

An alloy of copper and zinc and can contain anything up to 40% zinc to give the desired properties.

### Bronze

An alloy of copper and tin. The range of alloys can contain anything up to 18% tin to give the desired properties.

### Monel Metal

An alloy containing nickel and copper with small percentages of manganese and iron. Good mechanical properties and excellent corrosion resistance. Monel metal is easily welded (although this is very expensive) and therefore tends to be considered where steel gear cannot be used under any circumstances, such as acidic conditions.

31

### Aluminium

Aluminium is very light (one third that of steel) and has good corrosion resistance.

Its typical uses are jacks, jaw winch casings, hand chain hoist covers, flat webbing sling eyes and, most notably, for ferrules for wire rope eyes.

Mobile Lifting Frames and profile runway beams are also manufactured from lightweight aluminium extrusions, e.g. light crane systems produced by many manufacturers.

Notes:

## Strain Age Embrittlement

Alloy steel may contain impurities or additional elements to produce the required properties.

It is impossible to prevent the molten iron from partial oxidation.

Oxides in the finished steel can produce a form of brittleness known as strain age embrittlement. If the steel is over-strained, followed by resting in warm conditions, the steel may become very brittle.

Addition of elements such as **manganese, silicon or aluminium** which attract oxygen, will de-oxidise the steel and produce a steel known as 'killed steel'. This eliminates strain age embrittlement.

## Steel Grades Used in Lifting Equipment

Grade <b>4 (M)</b> has a breaking strength of	<b>400 N/mm<sup>2</sup></b>
Grade <b>6 (S)</b> has a breaking strength of	<b>600 N/mm<sup>2</sup></b> (BS EN 818 states <b>630 N/mm<sup>2</sup></b> )
Grade <b>8 (T)</b> has a breaking strength of	<b>800 N/mm<sup>2</sup></b>
Grade <b>10 (V)</b> has a breaking strength of	<b>1000 N/mm<sup>2</sup></b>
Grade <b>12 (W)</b> has a breaking strength of	<b>1200 N/mm<sup>2</sup></b>

## Polymers

Polymers are of two types:

- **Natural Polymers** such as shellac, wool, silk and natural rubber have been used for centuries. A variety of other natural polymers exist, such as cellulose, which is the main constituent of wood and paper
- **Synthetic Polymers** are materials such as synthetic rubber, resin, nylon, polyvinyl chloride (PVC or vinyl), polypropylene, polyamide, polyester and many more

Polymer products are lightweight which makes them ideal for moving around from job to job. The properties of polymers can be altered by introducing additives such as plasticisers and stabilisers.

In the lifting equipment industry, polymers are commonly used for roundslings and flat webbing slings, ropes, gears, bushes and sheaves.

Nylon compounds, often in association with latex and rubber, are also used to manufacture wear seals, pressure seals and oil seals.

## Natural Products

### Natural Fibres

Fibre rope slings are the traditional form of textile sling whose origins are recorded in the earliest history of lifting equipment. Although their use has declined in recent years in favour of the newer forms of textile slings, i.e. flat woven webbing slings and roundslings, they may still be found in general use throughout industry. Natural fibres are produced from grasses and other leaves that are spun to form ropes.

Fibre rope slings are produced from cut lengths of rope which are then hand spliced.

Common natural fibres for rope slings include manila, hemp and sisal.



Notes:

## 4. BASIC HEAT TREATMENT

When a piece of steel is worked, for example by bending, forging or welding, stresses are set up between the grains and their shape is altered. Heat treatment can be used to relieve those stresses and return the grains to their original shape, or change the size and structure of the grains.



Heat treatment is classed as any thermal treatment that alters the physical and chemical properties of a material. For example:

- Increase strength (hardening a material)
- Decrease strength (soften a material)
- Complete (through) or surface hardening of a material
- Toughening a material by tempering
- Stress relieving a material to remove residual stress
- Annealing a material after cold working to soften the material or to refine its grains

34

Metallic materials consist of a microstructure of small crystals called grains or crystallites. The nature of the grains (i.e. grain size and composition) is one of the most effective factors that can determine the overall mechanical behaviour of the metal.

Although each of these processes bring about different results in metal, all of them involve three basic steps: heating, soaking, and cooling.

Through a variety of heating, soaking (holding a material at a predetermined temperature for a specific period of time) and then cooling it, the microstructures of a material can be changed to produce desired characteristics.

Heat treatment can therefore change properties of materials, such as:

- Toughness
- Brittleness
- Ductility
- Hardness

We will consider the subject of heat treatment in detail on the LEEA Lifting Equipment General Advanced Programme training course.

Notes:

## 5. UNITS OF MEASURE



### What is a Unit of Measure?

A unit of measure can be described as a standardised quantity of a physical property, used to determine multiple quantities of a given property. For example:

- Weight
- Length
- Mass
- Force

Different systems of units are based on different choices of a set of fundamental units. The most widely used system of units is the International System of Units, or SI. There are seven SI base units. All other SI units can be derived from these base units.

36

Under the SI system when marking lifting equipment only one decimal point is used for fractions of a tonne e.g. 2.1t, apart from when marking 0.25 which is always to two decimal places.

e.g. 2.1t, 2.2t, 2.25t, 2.3t, 2.4t, 2.5t, 2.6t, 2.7t, 2.8t, 2.9t

Note: Some manufacturers also use .75

### SI Base Units

- **Metre** for length
- **Kilogram** for mass
- **Second** for time
- **Ampere** for electrical current
- **Kelvin** for temperature
- **Candela** for luminous intensity
- **Mole** for amount of substance

### Imperial Units (Examples)

- **Thou, inch, foot** and **yard** for length
- **Acre** for area
- **Fluid ounce, pint** and **gallon** for volume
- **Pound, stone, hundredweight** and **Ton** for weight

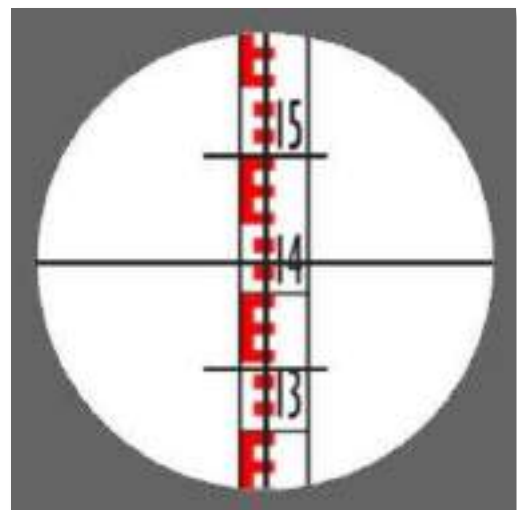

## Conversions

Some countries use different versions of the same measurement. For example:

1 Ton (U.S.)	= 2000 lbs (pounds)	= 907.185 kg (kilogrammes)	= 0.907 tonne (metric)
1 tonne (metric)	= 1000 kg (kilogrammes)	= 2204.62 lbs (pounds) <b>Rounded to 2204 lbs</b>	
1 Ton (imperial)	= 1016 kg (kilogrammes)	= 2239.9 lbs (pounds) <b>Rounded to 2240 lbs</b>	
1 cwt (hundred weight)	= 50 Kg		

### Hundredweight

Occasionally, lifting accessories may be found in service today with a marked safe working load or working load limit of 'cwt'.

1 hundredweight (cwt) = 50 kg

Hence, a marked load limit of 2 Ton 1 cwt = 2050kg, rounded down to 2t.

The hundredweight was established in the imperial measurement system in which 1 Ton is divided into 20 subdivisions, each being a hundredweight.

37

### Other useful conversions for the potential lifting equipment inspector:

1 kg	= 2.2. lbs
1 inch	= 25.4 mm
1 foot	= 12 inches
12 inches	= 304.8 mm
10 kN	= 1000 kg

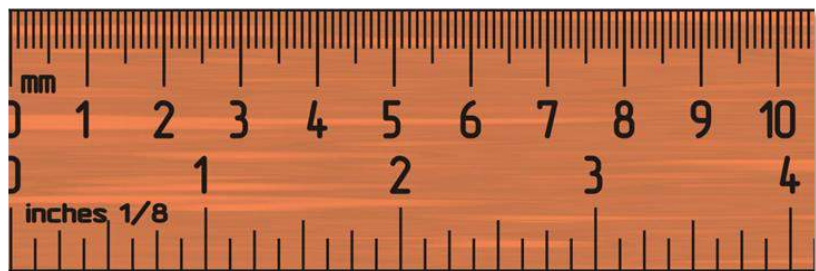

Notes:



## 6. BASIC FORCE, STRESS AND STRAIN

This unit looks at stress and strain in simple terms as they relate to lifting equipment.

It is unlikely that you will be called upon to carry out stress calculations as a lifting equipment examiner, however, it is important to have an understanding of their effects on the equipment being examined and possibly tested.

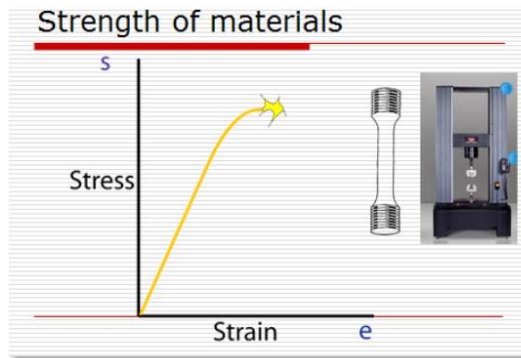

### Stress

When a force is applied to an item, the material that it is made from tries to resist the force. For a given material, the larger the cross-sectional area, the better it is able to resist the force due to the limiting factor being the stress not the amount of force.

38

Stress is the force per unit area. The SI unit for stress is the Newton per square metre, expressed as  $N/m^2$ . The accepted multiples used are  $kN/m^2$  and  $MN/m^2$ .

When calculating stress, the material section is usually measured in mm giving an answer in  $N/mm^2$ . This is easy to convert as  $1 N/mm^2 = 1MN/m^2$ . Strictly speaking the SI unit of stress has its own name which is Pascal, It is abbreviated to Pa.  $1Pa = 1N/m^2$ . This unit was used for a while in standards but has now fallen out of favour and recent standards use  $N/m^2$  or the accepted multiples.

Stress is determined by the force per unit area, i.e. stress is force divided by the cross sectional area of the item.

**Note:**  $1 kgf/mm^2 = 9.81 MN/m^2$

Notes:

## Strain

The force on the item puts the material from which the item is made under stress. To resist that stress, the material deforms. If it is in tension it gets longer and if it is in compression it gets shorter. The way that deformation is measured is by relating the amount of deformation to the original length.

The relative deformation is called Strain. The strain is determined by dividing the change in length by the original length.

## Loading Conditions

Lifting equipment may be subjected to single or multiple types of stress:

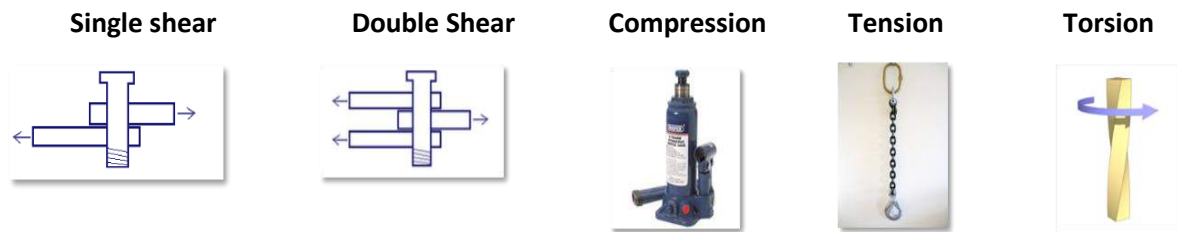

## Basics of Force, Stress and Strain

Basic formulae for the calculation of stress and strain:

$$\text{Stress} = \text{load (Force)} \div \text{cross sectional area}$$

$$\text{Strain} = \text{change in length} \div \text{original length}$$

Notes:

## The Tensile Test

The tensile test, also known as tension test, is probably the most fundamental type of mechanical test you can perform on material.

The tensile test reveals a great amount of information about the material and quantifies the important properties of the material. Lifting equipment examiners need to know these properties and how they are determined in order to understand various material specifications and relate these to their suitability for making lifting equipment.

A standard size specimen of the material to be tested is machined to a predetermined size. The cross section of the specimen is usually round, square or rectangular. For metals, a piece of sufficient thickness can be obtained so that it can be easily machined, a round specimen is commonly used. For sheet and plate stock, a flat specimen is usually used.

From the tensile test we can use the results to determine how a material will react under tensile loading. Typical properties revealed include the elastic limit, yield point, ultimate tensile strength and elongation/reduction in cross sectional area of the material under test.

A tensile load is applied to the specimen until it fractures. During the test, the load required to make a certain elongation on the material is recorded. A load/elongation curve is plotted by a recorder so that the tensile behaviour of the material can be obtained. An engineering stress-strain curve can then be produced:

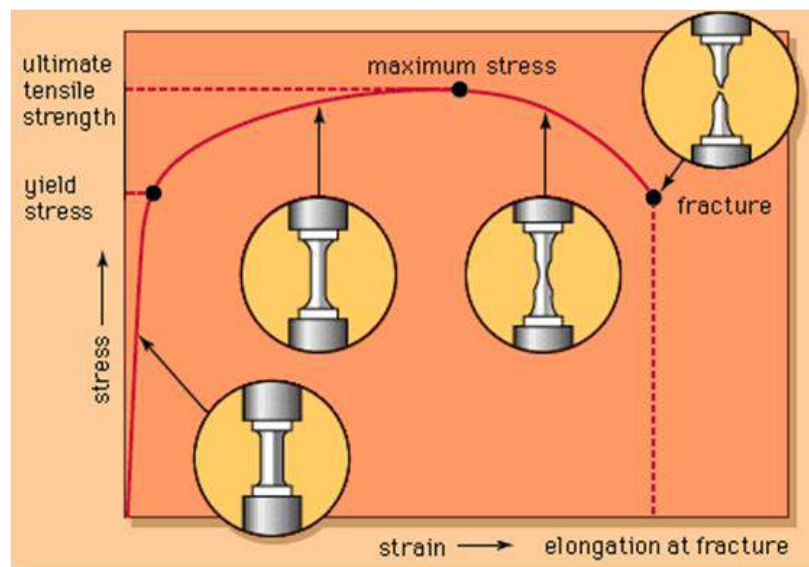

Notes:

## Tensile Test Result

The result is a Load/Extension diagram. This is also a diagram of Stress/Strain as the load results in stress and the extension is a measure of the strain.

Five definite points can be seen as the line of the graph is produced.

- A. Limit of Proportionality
- B. Elastic Limit
- C. Yield Point
- D. Tensile Strength
- E. Ultimate Breaking Stress

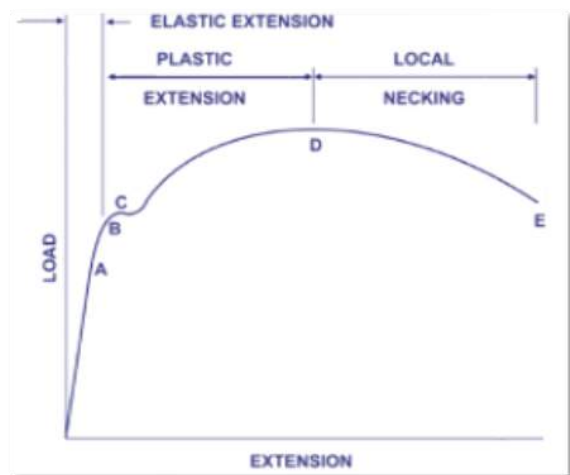
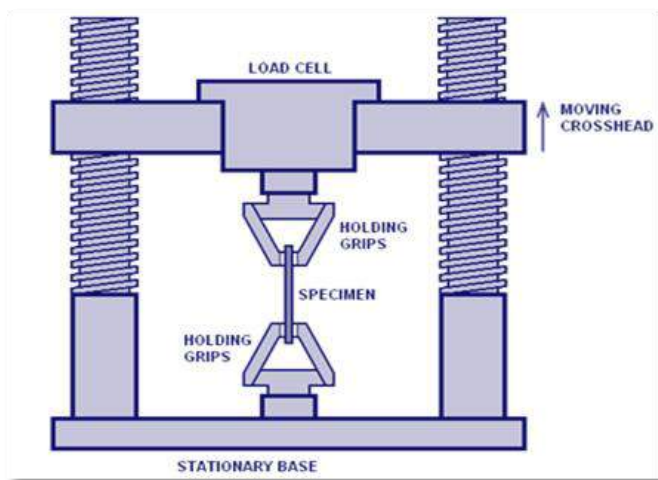

41

## Tensile Test Definitions

### Limit of Proportionality

Initially as the force is applied the stress and strain are proportional until point A is reached. This is the point at which the graph is no longer a straight line. This point is known as the Limit of Proportionality.

### The Elastic Limit

This is the point up to which the material remains elastic. Within the elastic limit the test piece will return to its original dimensions if the load is removed. (With mild steel this point practically corresponds with the Limit of Proportionality. This is not generally true of other materials or for materials that have been overstrained). When this point has been exceeded the extension is permanent and is referred to as Plastic Deformation.

### Yield Point

Slightly above the elastic limit, the Yield Point is reached when a sudden permanent extension, B to C, occurs without any increase in load. (Sometimes there is a slight drop in the load, due to the extension, giving an upper and lower yield point).

## Tensile Strength

The Tensile Strength is reached at this point. When this is passed the cross-sectional area becomes noticeably smaller and 'necking' occurs. This is the point of maximum load.

## Ultimate Breaking Stress

This is the actual breaking load where an increase in stress is obtained with a reduction in load. Although the value is smaller than the tensile strength this gives a false impression of what actually occurred. From points D to E the section of the test piece considerably reduces as it 'necks' - thereby effectively increasing the stress. However, as the graph records the stress as load over the original cross-sectional area, it appears to decrease

## Tensile Test Results

We can see from the tensile test graph opposite that there is a clear difference between a ductile material and a brittle material under the same tensile test.

The brittle test piece withstands deformation until the stress applied is at a relatively high level. It then yields, deforms and fractures.

The ductile test piece withstands deformation but yields at a lower level of stress than the brittle test piece. This is because the ductile material is not as strong as the brittle material.

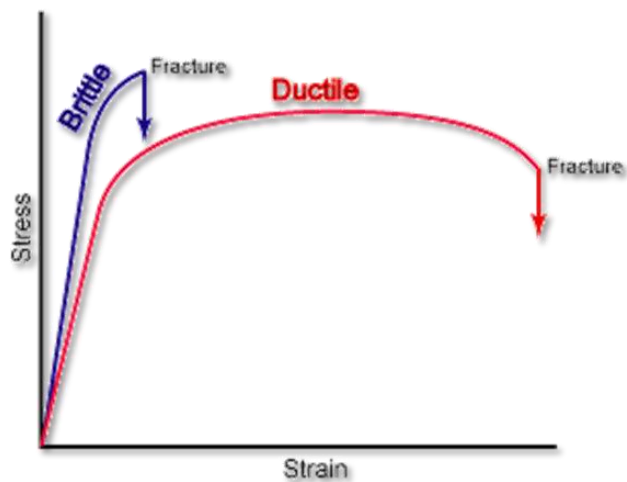

The ductile material then continues to elongate, reaching its maximum tensile stress and eventually fracturing.

Notes:

## 7. BASIC MECHANICS OF SIMPLE MACHINES

In engineering science, a machine can be defined as:

**‘Apparatus using mechanical power and having several parts, each with a definite function and together performing a particular task.’**

The simplest example is the lever, for even though it has no moving parts it meets the description.

The single sheave pulley block, which in its basic form, serves only to reverse the direction of the force is the simplest moving machine.

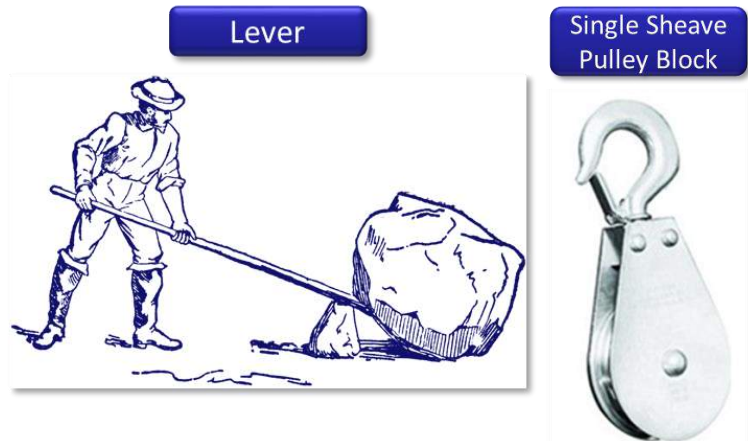

### Weight and Force

Although not strictly true, we will consider weight and force to be equal and expressed in the same units.

In a lifting machine a small weight or force is used to lift a larger weight or force. We call the force required to do the lifting, the effort, and the force being lifted, the load.

43

If we consider the single pulley and ignore friction, then if the load and effort are equal they will be in balance and remain stationary, that is to say be in Equilibrium.

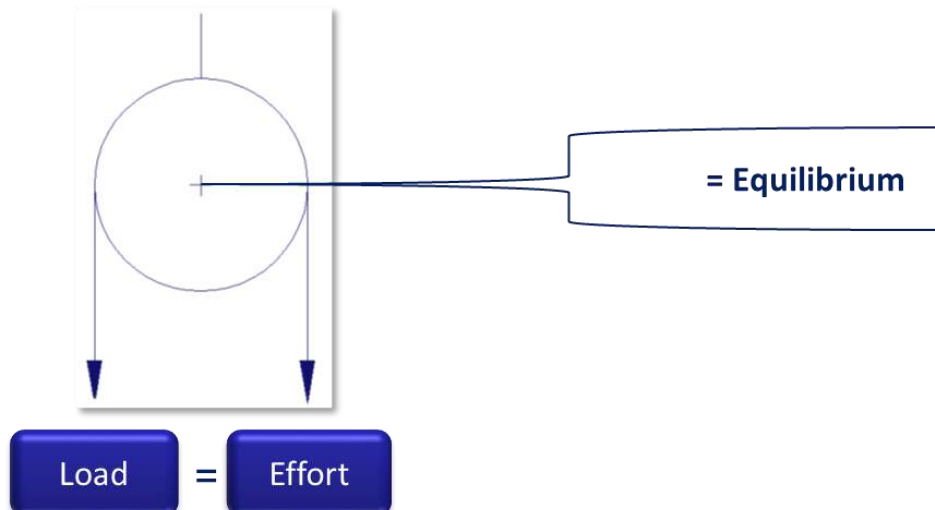

## The Lever and Moments of Force

At the beginning of this module, we mentioned that a lever may be considered as the most basic of machines.

There are many examples of the Lever in our everyday life, some are obvious others not so obvious, e.g. a spanner is an obvious example but a less obvious example is a jib crane. When a force is applied to a Lever it gives it a turning effect, which is known as the **Moment of Force** or **Turning Moment**.

**Moment of Force = Force x shortest distance to the line of action of the force**

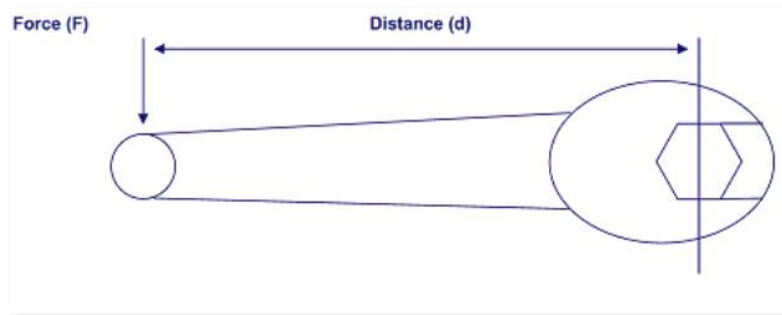

When we apply a force (F) on the spanner at a distance (d) from the centre of the bolt, the turning moment on the bolt is **F x d**

## Torque

Torque is important to the examiner and tester.

For example, the nuts of wire rope grips must be set to the correct torque, as must the foundation bolts of crane structures. These are set using a Torque Wrench, which allows the nuts to be tightened to a known torque.

In the course of our duties it is often necessary to check that nuts have been correctly tightened to the required torque.

Notes:

## The Couple

This type of Turning Moment is known as a Couple, where two equal and parallel forces are applied symmetrically about a point.

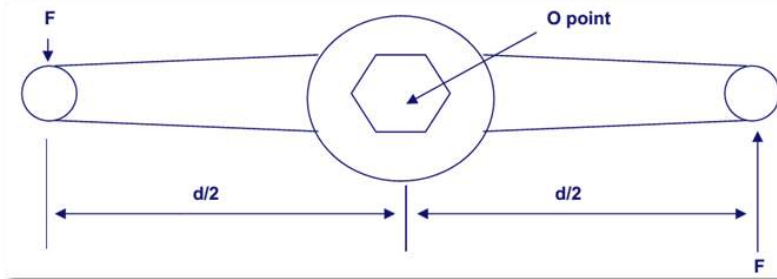

Here they act about a bolt centre (O).

The forces here are acting anti clockwise and would cause the bolt to turn. If however the forces were applied in opposite directions the lever would remain stationary, that is in Equilibrium, as the Anti clockwise Moment about point O = Clockwise Moment about point O. Point 'O' is the Pivot Point or Fulcrum about which the forces act.

## Mechanical Advantage

45

Any increase in the effort will move the load. In more complicated machines, e.g. a hand chain hoist, the effort required to move the load is usually much smaller than the load. Their relationship is known as the Mechanical Advantage. The mechanical advantage allows the device to perform the task for which it was designed.

If we consider the Mechanical Advantage of a simple winch, we can see that by increasing the lines of cable between the winch and the vehicle being pulled, we can pull more than the working load limit of the winch, e.g:

- 1t WLL winch and 1 line of cable = 1t Max. tow weight
- 1t WLL winch and 2 lines of cable = 2t Max. tow weight
- 1t WLL winch and 3 lines of cable = 3t Max. tow weight

(ignoring friction)

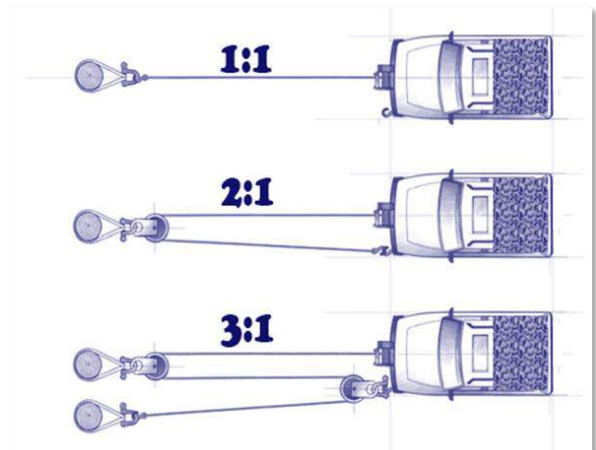

Notes:



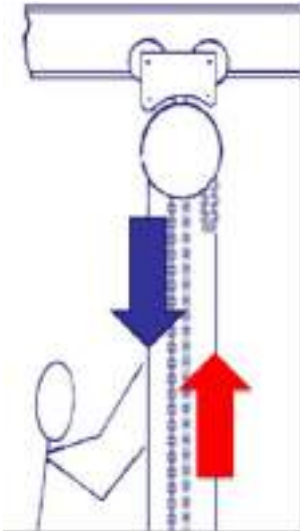

A chain hoist is operated by hand.

An operator will pull down on one of the chain loops on one side of the chain. This will turn a pulley mechanism inside the chain hoist housing. When this pulley turns, it will lift up the end of the other chain which usually has a hook on the end.

By pulling down on one chain, the manual hoist is actually able to increase the mechanical work that is being done. This is caused by the gear ratio inside the manual chain hoist.

Typically, the force exerted on the hand chain can be multiplied by the gearbox as much as 30 times.

In our opening comments we saw that the relationship of Load (W) to Effort (P) is known as the Mechanical Advantage (MA):

$$\text{Mechanical Advantage} = \frac{\text{Load}}{\text{Effort}} \text{ or } \text{MA} = \frac{W}{P}$$

Since the units of load and effort are the same MA has no units and is a simple ratio.

If we know the load to be lifted and the effort applied to a machine we can calculate the Mechanical advantage.

Notes:

## Velocity Ratio

The machine can move very large forces by applying only small ones.

Unfortunately, as we all know, you never get something for nothing and in order to move the load a short distance it is necessary for the effort to travel a greater distance.

The relationship between these movements is called the Velocity Ratio (VR).

$$VR = \frac{\text{Distance moved by effort}}{\text{Distance moved by load}}$$

The illustration opposite shows a series of pulleys where the load travels 1 metre for 4 metres of line pulled through the system.

$$VR = 4 \div 1 = 4$$

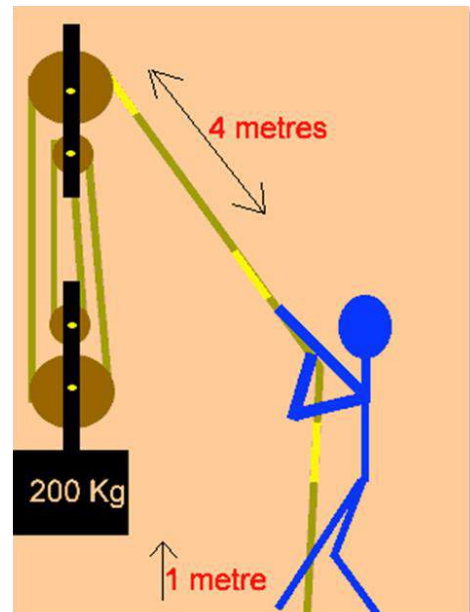

## Efficiency

No matter how well a machine is designed we can never get out more in total than we put in, in fact we get out far less. This is due in the main to friction, which is the enemy of movement. For example, **in a simple pulley a loss of between 4% and 9% of the force is accounted for by friction in the sheave**, therefore the more sheaves the greater the loss and the lower the 'efficiency' as the friction is cumulative.

Efficiency is then expressed as a percentage of the 'work done', i.e.  **$MA \div VR \times 100\%$**

### Example

A machine has a Mechanical Advantage of:

$$\text{Load (300kg)} \div \text{Effort (30kg)} = 10$$

**Velocity ratio** can then be calculated as:

$$\text{Distance moved by effort (50m)} \div \text{Distance moved by load (2m)} = 25$$

**Efficiency** is:

$$\text{Mechanical Advantage} \div \text{Velocity Ratio} \times 100$$

So efficiency can be calculated as:

$$10 \div 25 (\times 100) = \mathbf{40\% \text{ efficiency}}$$

## 8. METHODS OF MANUFACTURE

The vast majority of lifting equipment is manufactured from metals but steels are the most common. When the materials are in use, it affects the mechanical and physical properties of the metal. Corrective treatments are sometimes necessary to restore them. Treatment is usually by one of the common heat treatment processes which is used to give properties most suitable to the purpose for which the product is intended. It is important to have an understanding of the production methods and the faults that can occur in the processing.



### Steel Production

Modern steel production comes from both recycled as well as the tradition raw materials, iron ore, coal and limestone.

Two processes; basic oxygen steelmaking (BOS) and electric arc furnaces (EAF) account for virtually all steel production.

Notes:

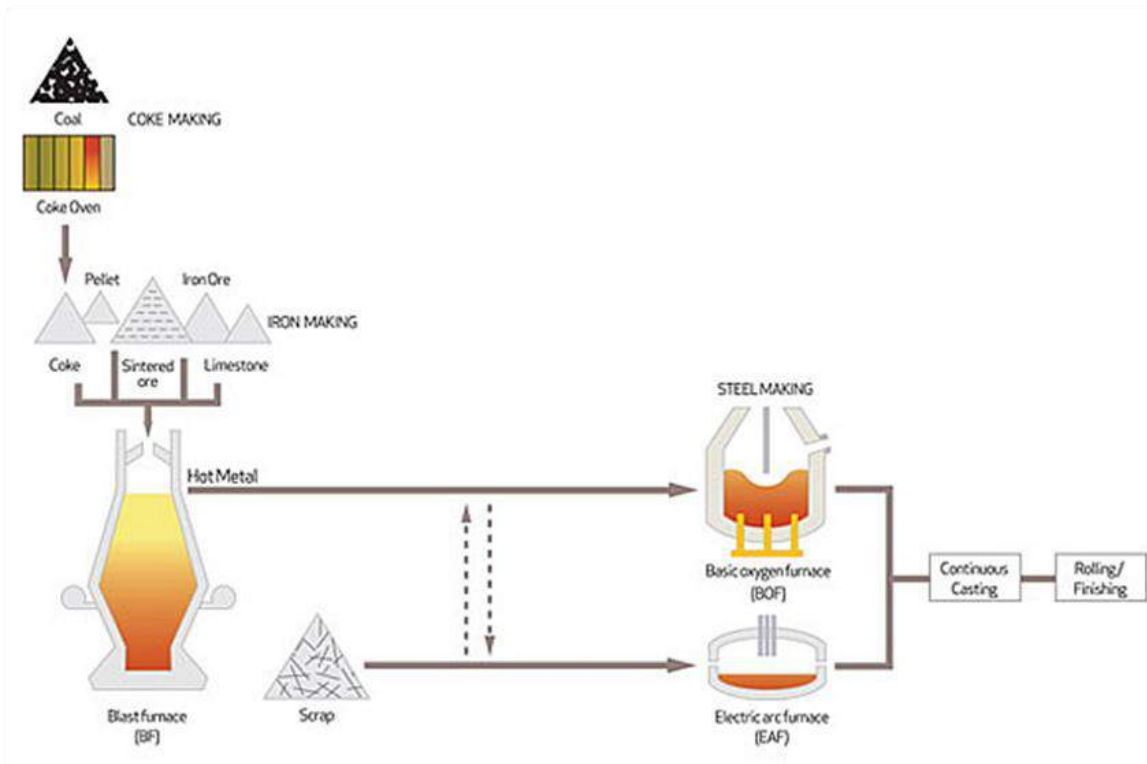

### Stage 1 – Iron Making

The raw inputs iron ore, coke and lime are melted in a blast furnace. The resulting molten iron - also referred to as 'hot metal' - still contains 4-4.5% carbon and other impurities that make it brittle.

49

### Stage 2 – Primary Steelmaking

Primary steelmaking methods differ between basic oxygen steelmaking and electric arc furnace methods. BOS methods add recycled scrap steel to the molten iron in a converter. At high temperatures, oxygen is blown through the metal, which reduces the carbon content to between 0-1.5%. EAF methods, alternatively, feed recycled steel scrap through use high power electric arcs (temperatures up to 1650 °C) to melt the metal and convert it to high quality steel.

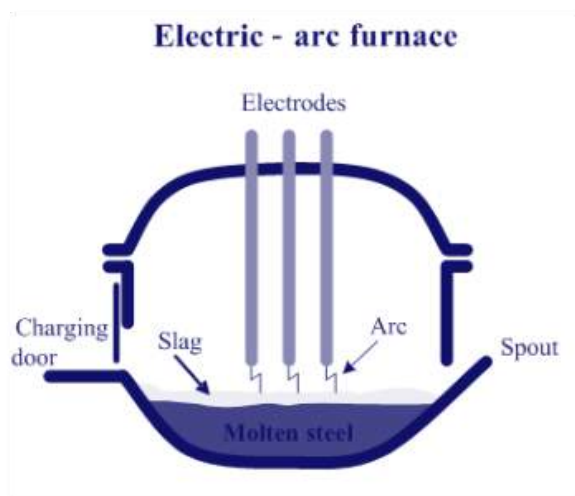
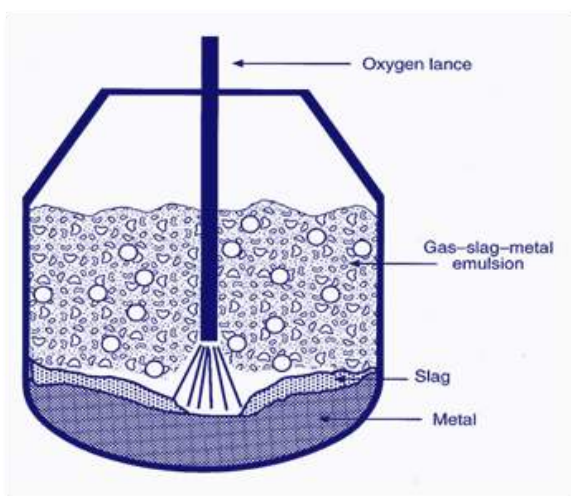

### Stage 3 – Secondary Steelmaking

Secondary steelmaking involves treating the molten steel produced from both BOS and EAF routes to adjust the steel composition. This is done by adding or removing certain elements and/or manipulating the temperature and production environment. Depending on the types of steel required, various secondary steelmaking processes can be used.

### Stage 4 – Continuous Casting

In this step, the molten steel is cast into a cooled mould causing a thin steel shell to solidify. The shell strand is withdrawn using guided rolls and fully cooled and solidified. The strand is cut into desired lengths depending on application; slabs for flat products (plate and strip), blooms for sections (beams), billets for long products (wires) or thin strips.

### Stage 5 – Primary Forming

The steel that is cast is then formed into various shapes, often by hot rolling, a process that eliminates cast defects and achieves the required shape and surface quality. Hot rolled products are divided into flat products, long products, seamless tubes, and specialty products.



### Stage 6 – Manufacturing, Fabrication, and Finishing

Finally, secondary forming techniques give the steel its final shape and properties.

## Refining and Rolling

Following initial production, ingots of cooled steel are reheated to a working temperature so that they become malleable, and are rolled out to refine their structure.

Refining increases the strength, ductility and toughness of the steel. This results from a breaking down of the coarser 'as cast' crystals of the ingot into much smaller ones by the action of the rollers. In addition, pockets of gas, which became trapped during pouring and can cause sponginess or blowholes in the ingot, are welded together by the rolling.

Steel sections are produced by further rolling processes. Although other finishing processes are sometimes used, it is rolled steel sections that the lifting equipment examiner will normally encounter. These include plate, flat, round, angle, channel and beam sections. The material can either be finished in the hot rolled state or, for some sections, subjected to a further cold rolling process.

Cold rolling has the effect of giving better dimensional accuracy and surface finish, whilst increasing the strength of the material. However, it reduces toughness and is more expensive to produce.

Notes:

## Forging

Forging ranges from simple hand work, as carried out by the village blacksmith, to the large mechanised forging processes used in mass production or for producing very large components (e.g. over 100 tonnes).

Many items of lifting equipment are produced by forging, including hooks, shackles and the like. The main object of forging is to bring the steel, as nearly as possible, to the desired shape and size. In other words, to produce a finished, or near finished, item.



In hand forging, the work is manipulated by the blacksmith with a hammer on an anvil using a few simple tools. The quality of the product is wholly dependent on the blacksmith's skill.

To achieve this, the three basic process stages are the same, whether for hand or mechanised forging:

1. **Drawing out** – reducing the section thereby increasing the length

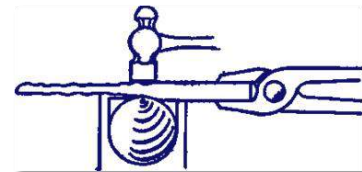

1

2. **Swaging** – forming of the section between dies

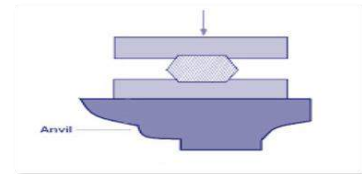

2

3. **Upsetting** – increasing the section thickness

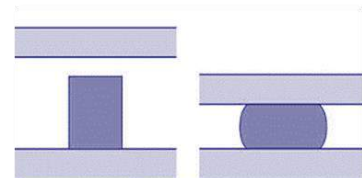

3

For mass production of forged components of the same shape, a process known as 'drop forging' is employed.

- Excess material is squeezed out as 'flash'
- Can be identified by the remains of the flash line around the component

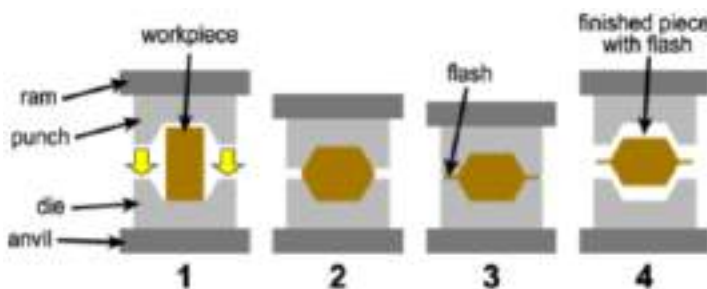



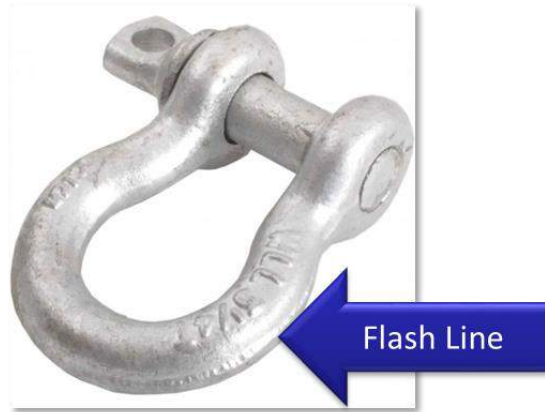

## Common Forging Faults

### Burning

Where the forged component has been heated for too long at too high a temperature. Oxide penetration of the crystals has taken place, which can be recognised by a glazed appearance.

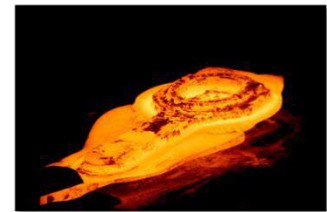

### Gall Marks

Caused by faulty manipulation of the tools, resulting in a lapping over of the material. If they have been hammered shut, they are difficult to see.



### Surface Cracks

Where the component has been over-stressed in manufacture, particularly on outside bends.

### Laminated Material

Will again act as a stress raiser which will eventually crack. This is often difficult to detect as its appearance will differ with its position and the methods of working applied to the material. Often it will look like a discoloured line running along or across the item.

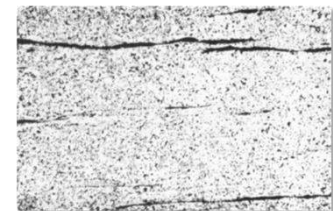

### Weld Faults

Must be considered when looking at welded rings and links. Weld cracks can develop during manufacture or in service. Other manufacturing weld faults are lack of penetration, appearing as a lap between the weld and the parent material, undercutting, gas blow holes and slag inclusions. These may be difficult to identify in links which have been welded before the final forging process.

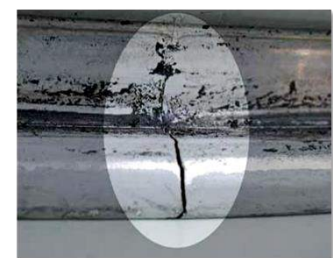

Notes:

## Casting

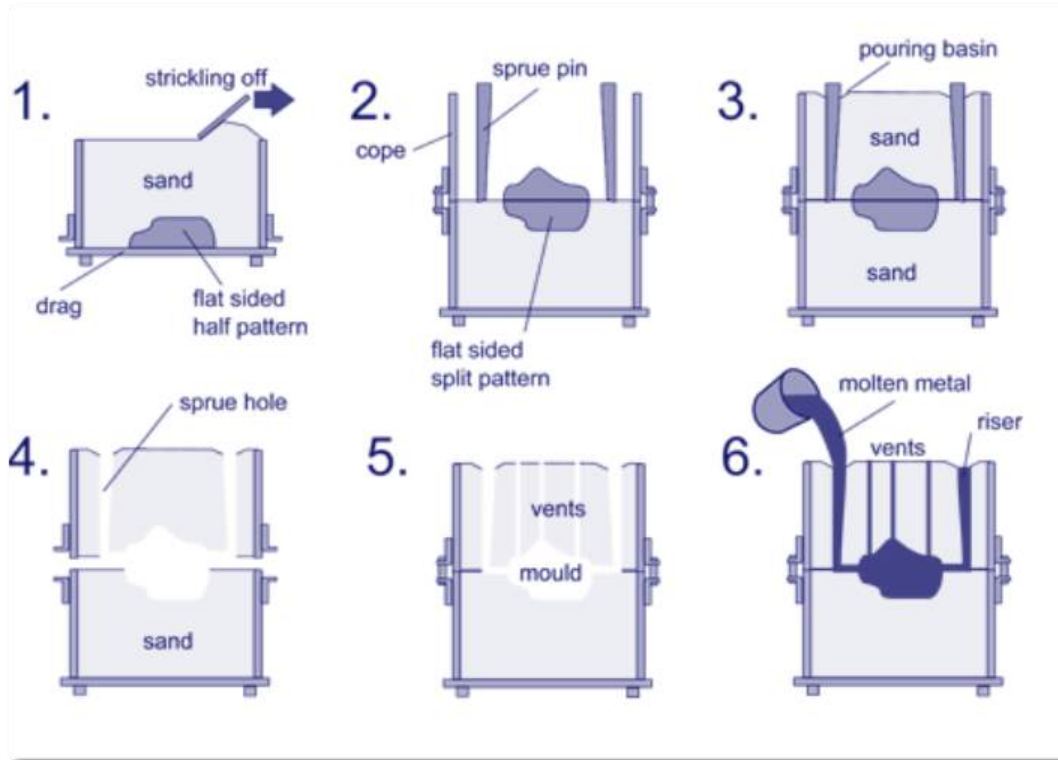

Sand Casting is a very common form of casting used for lifting equipment. It involves packing a moulding material (traditionally a mixture of sand and clay) around a pattern of the casting. This is usually made of a hardwood and will be larger than the requirements of the finished casting to allow for shrinkage. The mould is then split so that the pattern can be removed.

53

This process can be used for a large range of sizes and for small or large production runs. It is the cheapest casting process available for small production runs and can sometimes be economical for large production runs.

The surface finish and tolerances of the finished casting are poor. This form of casting can significantly alter the mechanical properties of the material being cast.

Notes:



## Common Casting Faults

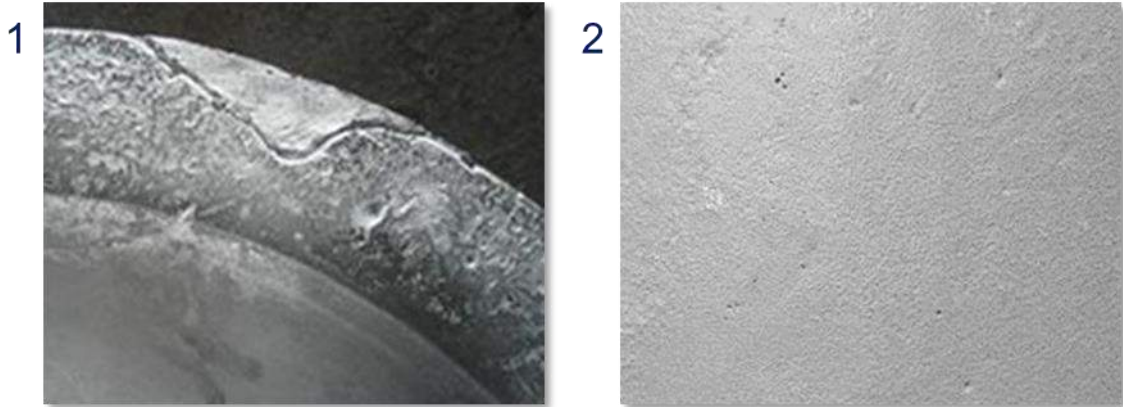

1. The **Cold Shut** is a crack with round edges. It occurs when molten metals of uneven temperatures meet and do not fuse together (too low a temperature)
2. The **Blowhole** is a small cavity defect which can be a series of pinholes. Pinholes are tiny holes. Surface blowholes can be seen after the cast has been machined to its finished size

## Welding



Welding is a technique used for joining metallic parts, usually through the application of heat.

Welders work with a lot of different metals, alloys and materials, heating, melting and joining these 'composites' together.

There are several different ways to weld, including Gas Metal Arc (MIG), Tungsten Arc (TIG), OxyFuel and Submerged Arc Welding (SAW).

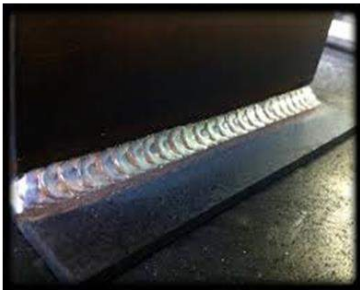

Lifting Beams, Spreader Beams, Overhead Cranes and supporting structures usually incorporate welding in their manufacture.

## Welding Faults

There are many types of welding faults. We will look at these in more detail during the LEEA Runways and Crane Structures Advanced Programme training course.

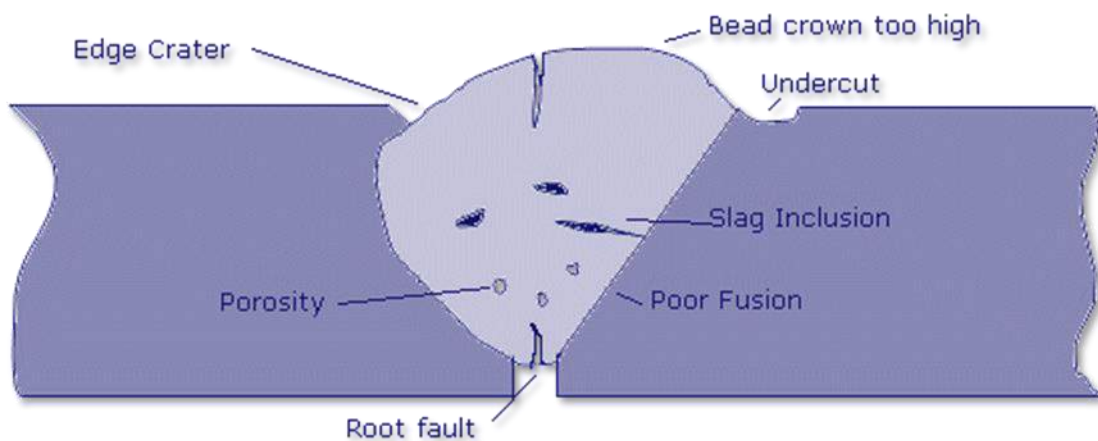
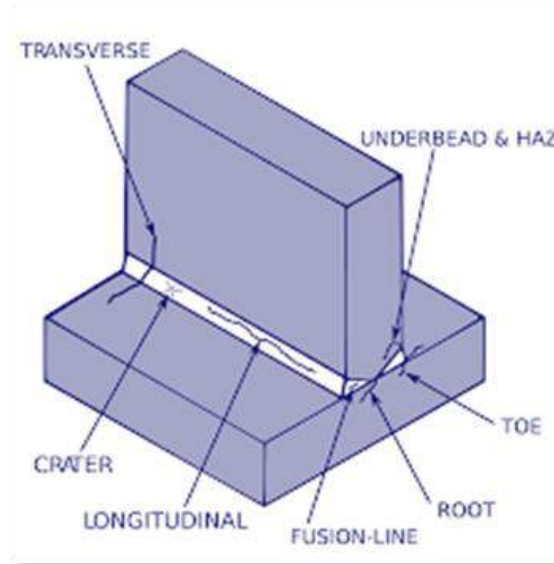

Notes:

## 9. VERIFICATION OF LIFTING EQUIPMENT

All lifting equipment must be verified:

- i. To ensure it is safe before first use, and
- ii. Periodically once it is in service to ensure it remains safe to use

Until the end of the twentieth century, all of the various UK regulations, and therefore the standards, called for lifting equipment to be proof load tested and examined to ensure this was the case. This was irrespective of the logic or need for such a test. Users were then required to retain the test certificate and examination reports.



Modern legislation, standards and codes of practice take a more sensible approach.

For certain products, proof load testing remains valid. However, for many common items, this is not the case and other tests are more meaningful.

Standards give the verification methods for new products, although it is no longer necessary for the user to be given the results.

For in-service equipment, LOLER places the duty for deciding if, and what, tests are necessary on the competent person making a thorough examination. It requires the details of any tests made to be included on the examination report. Note the words 'any test'. The report needs to include any functional, light load, non-destructive tests etc., not just a proof load test.

### Types of Verification

There are many types of verification and test available to the examiner:

- Dimensional Verification
- Operational Test
- Light Load Test
- SWL and Deflection Measurement
- Proof Load Test
- Breaking Load Test/Minimum Breaking Load
- Hardness Test
- Dye Penetration
- MPI
- Radiography (x-ray)
- Eddy Current
- Electromagnetic Wire Rope Examination
- Etc.



## Test Machines and Force/Load Measuring Equipment

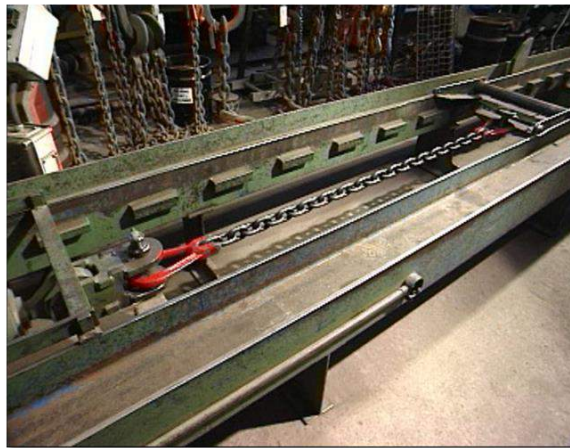

Many of the product standards and codes of practice which require the application of a load, or force, lay down the accuracy to which the test load or force must comply. For example, BS EN 818-1 for chain requires an accuracy of  $\pm 1\%$ .

The LEEA Technical Requirements for Members, Document reference LEEA 044, dated 6th May 2010. It requires that test machines and load cells are calibrated and verified by a competent person, or authority, in accordance with BS EN ISO 7500-1 at intervals not exceeding 12 months. It further requires that the accuracy of the applied load/force must be within that required by the standard being worked to and, in all cases, within  $\pm 2\%$  of the nominal load/force.

57

BS EN ISO 7500-1 has various classes or grades of machines: 0.5, 1.0 or 2.0. This relates directly to the accuracy. Grade 0.5 =  $\pm 0.5\%$ , 1.0 =  $\pm 1\%$  and 2.0 =  $\pm 2\%$ . This information will be given on the certificate of calibration and verification. In some cases, dependent on the design and construction of a test machine, or load measuring device, two grades may be shown. For example, grade 1.0 for one range of readings, grade 2.0 for a further range of readings.

The certificate will also give the Lower Limit of Calibration. This will be expressed as a load or force, depending on the units in which the machine or device is calibrated. This is the minimum load/force that can be read from the display within the required accuracy. Test loads below this cannot be measured with this equipment. In some cases, there may also be a similar restriction on the upper limit.

The person performing any form of load test must be aware of the limitations for use imposed on the test machine, or load/force measuring equipment, and ensure that the accuracy of the applied load meets the requirements of the standard being worked to.

Notes:



## Dimensional Measuring Equipment

Only the most basic of dimensional measuring equipment, such as a tape or rule, is usually called for in the verification of lifting equipment. This should be graduated to national standards in increments of 1 mm.



For certain items, a Vernier gauge may be necessary. In this case a graduation of 0.1 mm is usually sufficient when examining general lifting equipment.

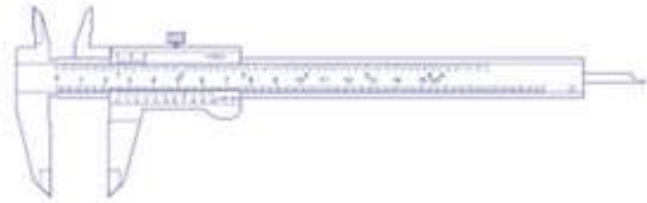

LEEA Technical Requirements requires that a procedure is in place for checking and verifying measuring devices at appropriate periods. For tapes and rules, it will probably only be necessary to regularly check them to ensure that they are undamaged. However, precision measuring equipment will require periodic verification.

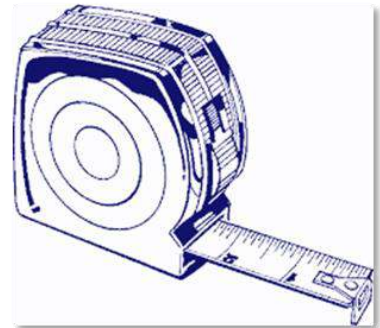

## Crack Detection

When dealing with general lifting equipment, usually only basic crack detection (such as dye penetrate or magnetic particle) is performed to examine welds. Trained operatives are required in order to perform the tests and interpret the results. The tests are relatively inexpensive, both in terms of the equipment and the labour necessary to perform the tests.



For more detailed crack detection examinations, particularly on high value items or where additional safety requirements require a higher degree of examination, other methods used are eddy current, radiography and ultrasonic. These are more expensive to perform and call for a high degree of training and skill to interpret the results.



### Dye Penetrant

Dye Penetrant crack detection is used to locate cracks, porosity, and other defects that break the surface of a material and have enough volume to trap and hold the penetrant material. Liquid penetrant testing is used to inspect large areas very efficiently and will work on most nonporous materials.

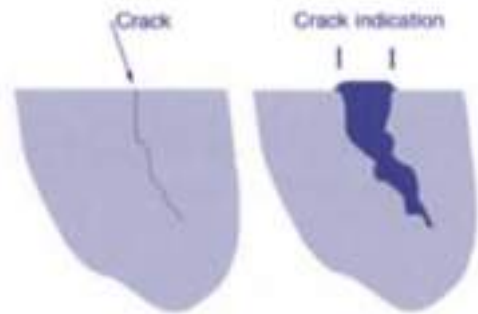

### Magnetic Particle Testing

Used for the detection of surface cracks and laminations in ferrous/magnetic materials and is primarily used for crack detection. The specimen is magnetized and if the material is sound, the magnetic flux is predominantly inside the material. If there is a surface-breaking flaw, the magnetic field is distorted, causing local magnetic flux leakage around the flaw. This leakage flux is displayed by covering the surface with very fine iron particles applied either dry or suspended in a liquid.



### Eddy Current Testing

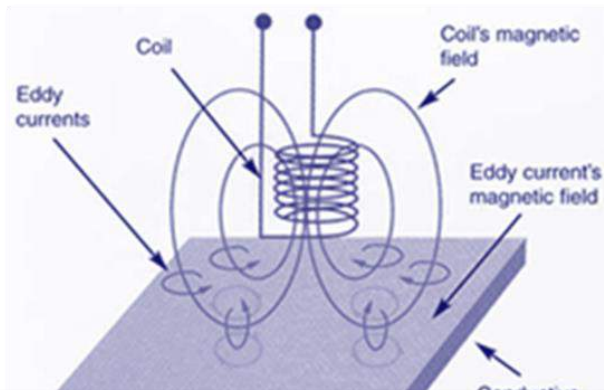

Eddy Current is used to detect surface and near-surface flaws in conductive materials, such as the metals. Eddy current inspection is also used to sort materials based on electrical conductivity and magnetic permeability, and measures the thickness of thin sheets of metal and nonconductive coatings such as paint. Eddy Current detects surface and near surface defects.

### Ultrasonic Testing

Ultrasonic Testing is used to locate surface and subsurface defects in many materials including metals, plastics, and wood. Ultrasonic inspection is also used to measure the thickness of materials and otherwise characterize properties of material based on sound velocity and attenuation measurements.

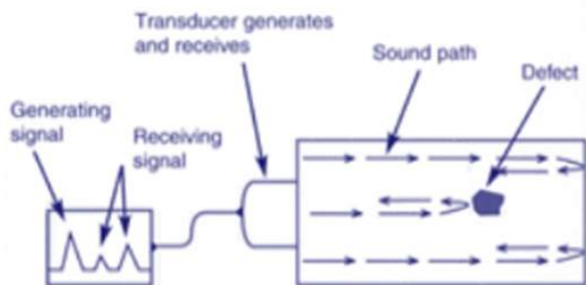

### Radiographic Testing

Radiography (RT) monitors the varying transmission of ionising radiation through a material with the aid of photographic film or fluorescent screens to detect changes in density and thickness. It will locate internal and surface-breaking defects.

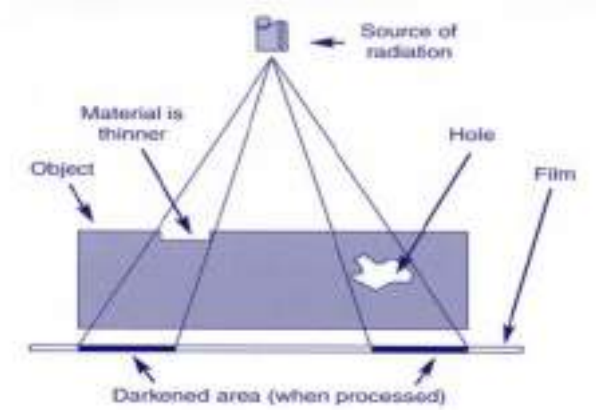

### Electromagnetic Wire Rope Examination

This is a fast method of detecting defects in long lengths of wire rope. The rope is passed through a magnetic field. Breaks and disturbances in the magnetic field are detected and a printout of the field is given.

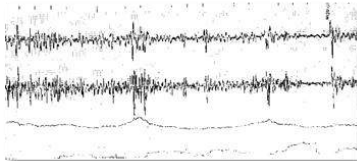

The test involves using an instrument to examine ferromagnetic wire rope products in which the magnetic flux and magnetic flux leakage methods are used. If properly applied, the magnetic flux method is capable of detecting the presence, location, and magnitude of metal loss from wear, broken wires, and corrosion, and the magnetic flux leakage method is capable of detecting the presence and location of flaws such as broken wires and corrosion pitting.

### Hardness Testing

Indentation methods are used to verify the hardness of lifting equipment following heat treatment or where equipment is used in conditions that might affect the heat treatment. There are three basic methods: Vickers, Brinell and Rockwell. Brinell is the most common method used in the lifting equipment industry.

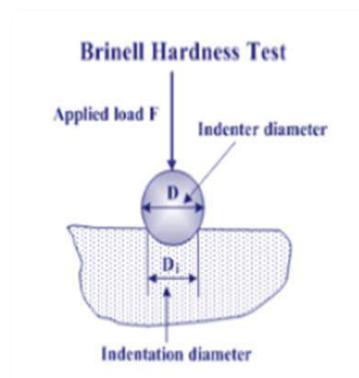

The Brinell Test

### Charpy Impact Testing

The Charpy impact test, also known as the Charpy V-notch test, is a test which determines the amount of energy absorbed by a material during fracture. This absorbed energy is a measure of a given material's notch toughness and acts as a tool to study temperature dependent ductile to brittle transition.

A specimen is supported at its two ends on an anvil. Struck on the opposite face to the notch by a pendulum, the specimen is fractured and the pendulum swings through. The height of the swing measures the amount of energy absorbed during fracture. Three specimens are tested at any one temperature.

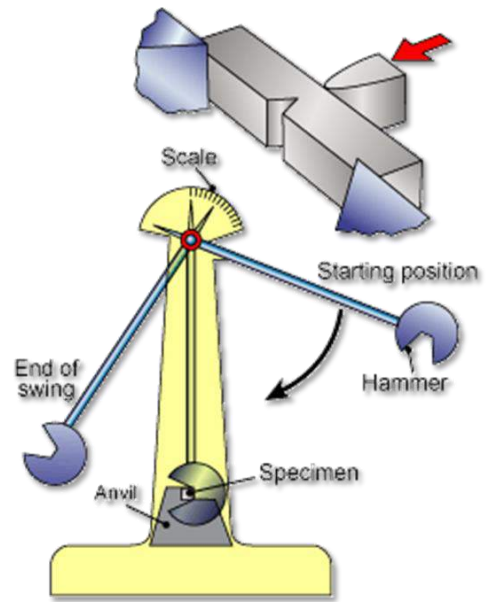

### Izod Impact Testing

The Izod Impact test is similar to the Charpy test but in this test, the material is held vertically in a vice type jaw and is in cantilever.

Izod impact is defined as the kinetic energy needed to initiate fracture and continue the fracture until the specimen is broken. Izod specimens are notched to prevent deformation of the specimen upon impact. This test can be used as a quick and easy quality control check to determine if a material meets specific impact properties or to compare materials for general toughness.

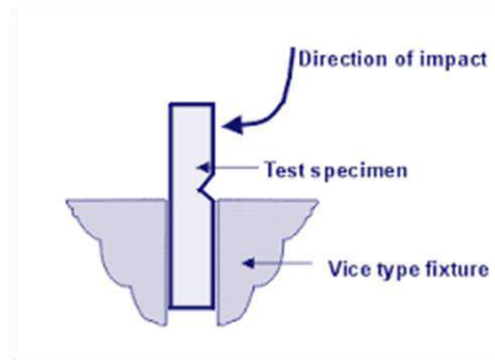
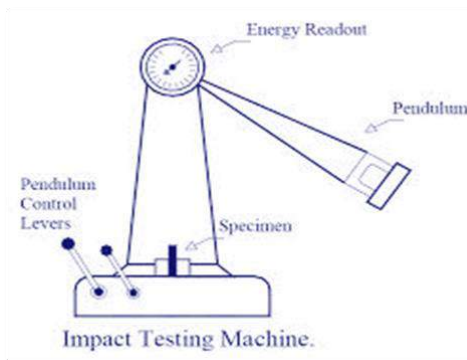

Notes:



### The Bend Test

The Bend Test is a simple and inexpensive qualitative test that can be used to evaluate both the ductility and soundness of a material. It is often used as a quality control test for butt-welded joints, having the advantage of simplicity of both test piece and equipment.

The test can terminate at a given angle of bend over a specified radius or continue until the specimen legs are in contact. The bend angle can be measured while the specimen is under the bending force or after removal of the force as when performing a free-bend test. Product requirements for the material being tested determine the method used.

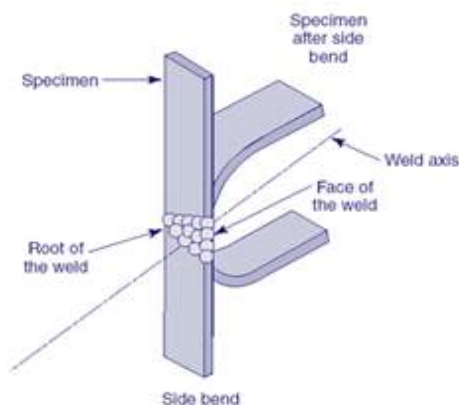

### Marking of Lifting Equipment

Sometimes it may be necessary to re-mark equipment but this can induce stress raisers.

Mark on selected areas where effects are minimised  
Stamping should neither be too sharp or excessively deep

Where standards do not specify size of marking, LEEA recommends the following size stamps with a material diameter up to and including:



<b>12.5 mm</b>	-	<b>3 mm stamp</b>
<b>12.6 -26 mm</b>	-	<b>4.5 mm stamp</b>
<b>26 mm +</b>	-	<b>6 mm stamp</b>

Notes:

## 10. RATING AND MARKING OF LIFTING EQUIPMENT

How do we establish the maximum load that an item may lift in any particular circumstance?

The principles for rating the various items are much the same, however we will look more closely at slings as they require a more detailed explanation.



### Rating of Lifting Accessories

The terms used in the legislation, the standards, found in manufacturers' literature and in various codes of practice are in everyday use.

63

We need to understand the meaning of these terms:

#### Lifting Equipment

This term is used in two different ways in LOLER. It is a generic term used to cover all lifting accessories and appliances, but also has a more specific meaning covering lifting appliances and their anchorages and fixings.

#### Lifting Accessories

Any device such as a sling, shackle, eyebolt, clamp, spreader beam etc used to connect the load to a lifting appliance but which is not itself part of the load or the appliance. At one time lifting accessories were referred to as 'lifting gear' or 'lifting tackle'. Although both these terms are still in common use, 'lifting accessories' is the only term used in the Supply of Machinery (Safety) Regulations and LOLER. In reference to lifting accessories we will often use the term 'lifting gear' or simply 'gear' in the text.

#### Lifting Machine/Lifting Appliance

A device or mechanism, such as a crane, crab, winch, pulley block, gin wheel, chain block, which does the work in lifting the load or provides the means of movement, or the supporting structure and anchoring devices for such a mechanism, e.g. runway, gantry etc, which may also permit a suspended load to be moved in the horizontal plane. These items are covered by the term 'lifting equipment' in LOLER.

#### Working Load Limit (WLL sometimes called maximum SWL)

The maximum load or mass that an item of lifting equipment is designed to sustain, i.e. raise, lower or suspend. This is the load required to be marked on an item by the product standards.

### Safe Working Load (SWL)

The maximum load or mass (as certified by a competent person) that an item of lifting equipment may raise, lower or suspend under particular service conditions. It is the SWL which is required to be marked on the item by LOLER and which appears on any report of thorough examination.

### The Minimum Breaking (or failure) Load (MBL)

The minimum breaking load is the calculated load at which a sample of the item will break or fail. From this value is derived the WLL etc. In order to ensure that this value has been achieved for some products, e.g. wire rope, a sample may be tested to destruction and the actual breaking load recorded, or the wire from which the rope is made is tested and the aggregate breaking load is calculated. Other items are designed so as to sustain the WLL plus a minimum factor of safety, e.g. a roundsling, however they may fail if this is increased by only a tiny amount. For practical purposes we can consider these tests to be the same. For a new product a sample must not fail under test at a lesser amount than the minimum specified in the relevant standard.

The MBL should be expressed in the SI unit of force (Newtons) or Mass (tonnes, kilograms), as required by the relevant standard.

### Factor of Safety (FOS), Coefficient of Utilisation, Working Coefficient

These terms all have much the same meaning, but perhaps Factor of Safety describes the function better than the more recent terms, which are replacing it in standards and legislation. It is a factor which is applied to the MBL to determine the WLL. It varies with the product to take account of the susceptibility to damage and considers the type of stresses the item will meet in normal use.

Where the conditions of use are more severe than those considered by the product standard, e.g. in a chemical environment, the user will apply an increased FOS, so reducing the value of the SWL from that of the WLL.



Notes:

## SWL and WLL

Some confusion exists as to the WLL and SWL. The WLL is determined by the designer/manufacturer and is based on the mechanical properties of the item. A competent person specifies the SWL, based on the use to which the item will be put and will be dependant on:

- Whether the load is dead or alive
- The consequences of failure, e.g. when carrying radioactive material the risk is high and a greater factor of safety is called for
- How the load is applied, e.g. slowly or suddenly
- The degree of possible misjudgement of weights or angles
- The duty cycle and working environment
- Any other factors which affect the safe working life of the item or the safety of the lifting operation

The marked SWL normally has the same value as the WLL, but it may be less. For instance, in mining and nuclear power stations the WLL is often significantly reduced to obtain the SWL, as there are particular dangers associated with these activities and these call for higher safety margins than in, say, an engineering works.

For new equipment, the WLL/SWL should be expressed in SI units of mass, i.e. tonnes and kilograms. Older items may still be found in service which are marked in the imperial units of tons and hundredweights.

Manufacturers of standard or series produced items, who do not know the application in which the item will be used, specify the WLL, leaving the individual users to decide whether or not the 'factor of safety' is sufficient for their particular application. Where an item is being specially manufactured for a specific application the designer is able to take all of the relevant matters into account and can use the applicable factors, thus he is able to specify the SWL which is to be marked on the item.

## Rating of Slings

Each of the different material types of sling listed opposite may be found in any one of 5 different basic configurations for general purpose slings, i.e. single leg, two leg, three leg, four leg and endless slings.

Although examples may be found, roundslings, webbing slings and fibre rope slings are not common in the three leg and four leg configurations.

Selection of a suitable sling configuration depends predominantly on the type of load and examples of the use of the different types are given below. For certain types of load such as wooden cases, drums, long pipes logs etc., special slings are available and recommended.

Wire Rope Slings



Chain Slings



Fibre Ropes



Webbing Slings



Round Slings



When a multi-leg sling is used with the sling legs at an angle, the load in the individual sling legs will increase as the angle to the vertical (included angle between the legs) becomes greater.

Harmonised European Standards measure the angle between the leg and the vertical  $\beta$  (beta).

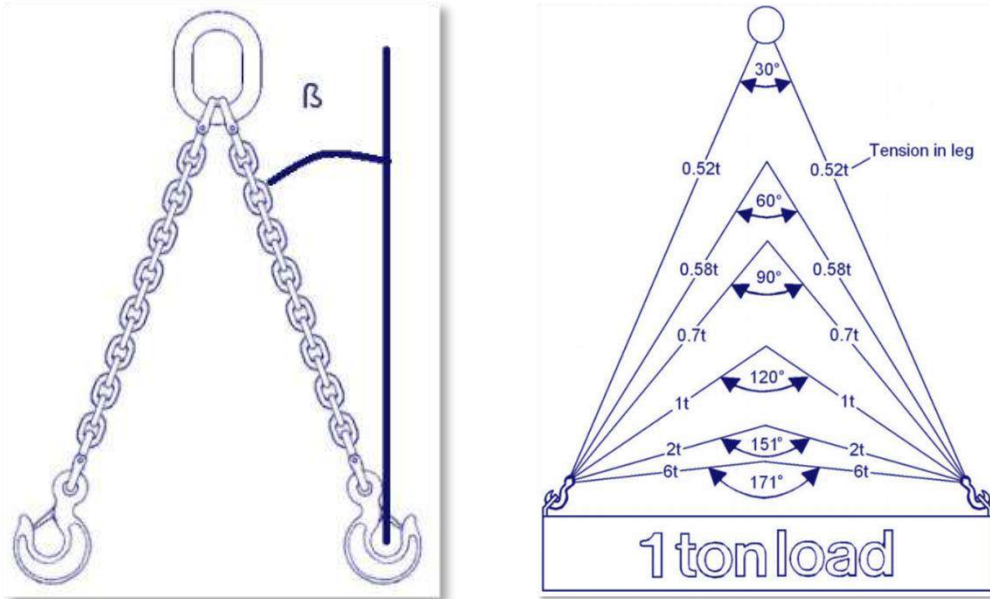

At the present time, many multi-leg slings in service will be marked with the rating expressed at the included angle or range of angles, e.g. 0-90°.

In the case of new multi-leg slings to the Harmonised European BS EN standards, the rating will be expressed at the range of angles of a leg to the vertical, e.g. 0-45°.

If a sling is to be used safely, allowance must be made for this angle and this is achieved by rating the sling in one of two ways. This matter is discussed in some detail in BS 6166, which specifies the methods and factors to be used in calculating the safe working load. The two methods of rating are often known as the ‘uniform load method’ and the ‘trigonometric method’.

Notes:

## The Uniform Load Method

The uniform load method is the simpler option, having inherent safety advantages, permitting only one working load limit up to an angle of 45° to the vertical (90° included angle) and a reduced working load limit at angles between 45° and 60° to the vertical (90° and 120° included angle). This is the method which should be used for all multipurpose slings and is the only method used for them in Harmonised European standards.

Working load limits are derived from the following:

<b>Single leg sling:</b>	<b>1.0</b> x WLL of a single leg
<b>Two leg sling</b> 0-45° (included angle 0-90°)	<b>1.4</b> x WLL of a single leg
<b>Two leg sling</b> 45°-60° (included angle 90°-120°)	<b>1.0</b> x WLL of a single leg
<b>Three and four leg sling</b> 0-45° (included angle 0-90°)	<b>2.1</b> x WLL of a single leg*
<b>Three and four leg sling</b> 45°-60° (included angle 90°-120°)	<b>1.5</b> x WLL of a single leg

\*In older British Standards covering textile slings, this factor is given as 2.0.

67

Recent British and European standards, where the uniform load method has been used, rate a multipurpose four leg sling at the same working load limit as a three leg sling of the same size and grade. This is on the assumption that the load might be taken by only three of the four legs; the fourth leg will balance the load.

**Note:** For calculation purposes using the Uniform Method of load rating, the 4th leg of the sling is redundant.

### Calculating a Mode Factor

The mode factor for various sling angles is derived from the cosine of the angle to the vertical and is used as follows:

### The Uniform Load Method Design Factors

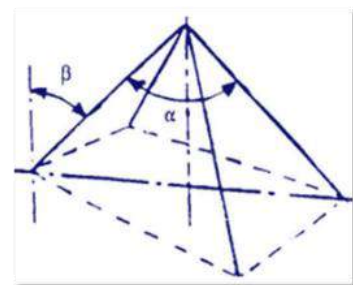
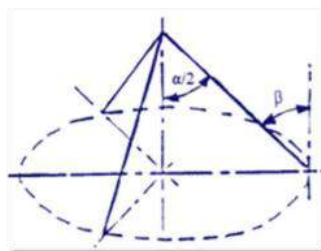
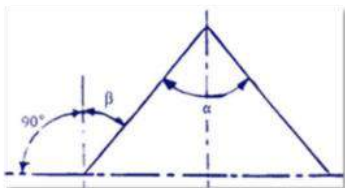



The following chart shows the design factors that should be applied to the WLL of a single leg to establish the WLL of multi-leg sling assemblies or where a number of single slings are being used in combination.

	0-45° (0-90°)	45°-60° (90°-120°)
2-leg sling	1.4	1.0
3 and 4-leg sling	2.1	1.5

## The Trigonometric Method

The trigonometric method provides for a variation in the working load limit as the angle to the vertical (or the angle between the sling legs) varies. This method is the one which was traditionally used in the United Kingdom but in order to use it for multipurpose applications, the operative must be provided with tables showing the safe working loads at various angles for each size of chain, rope, etc. It also requires the operative to be trained in judging a range of angles and has the inherent danger that if he should misjudge these, the sling may well be overloaded.

Although the uniform load method was introduced several years ago, some manufacturers continued to rate and mark multipurpose slings by the trigonometric method. Slings intended for multipurpose use marked this way will not comply with the requirements of Harmonised standards and it is strongly recommended that this method should be used only for slings designed for a single purpose, as specified in BS 6166 Part 1. Working load limits are derived from the following:

<b>Single leg sling</b>	1 x WLL of a single leg
<b>Two leg sling</b>	2 x WLL of a single leg x $\cos \beta$
<b>Three leg sling</b>	2.1 x WLL of a single leg x $\cos \beta$
<b>Four leg sling</b>	1.5 x WLL of a single leg x $\cos \beta$

$\beta$  is equal to the angle between the sling leg and the vertical (i.e. half the included angle  $\alpha$ )

Notes:

## Rating of Slings

The uniform load method simplifies matters by removing the need for tables and reducing the need for the operative to estimate angles. Whilst the uniform load method of rating is most easily applied to equipment such as multi-leg slings, it may, with advantage, also be applied to such items as eyebolts when used in pairs.

The current trend in British and international standards is in favour of the uniform load method and it is the only method used in Harmonised standards for multipurpose slings, largely on the grounds of safety and simplicity. It is therefore recommended that, in accordance with BS 6166, the uniform load method is used for all multipurpose applications and that the trigonometric method should be restricted to slings designed and used for a single purpose.

It should be clearly understood however that whilst equipment designed to be used under the trigonometric method may be re-rated and marked according to the uniform load method, the reverse is not always possible and may be dangerous. It is therefore recommended that, to avoid confusion, all items of a given type (e.g. all chain slings) at the location should be rated and marked by the same method.

### Multi-Leg Slings (User Information)

If a multi leg sling is used with less than its actual number of legs attached to the load, then obviously the safe working load of the sling must be reduced. The amount by which it should be reduced can be calculated exactly, but it is rather complex, as a number of factors need to be taken into account including the method of rating. An easy way of ensuring that the sling is never overloaded is to reduce the safe working load from that marked on the sling according to the number of legs in use.

eg a 4 leg sling with only 2 legs in use,  
REDUCED SWL =  $\frac{2}{4}$  ie  $\frac{1}{2}$  x SWL MARKED

a 3 leg sling with only 2 legs in use,  
REDUCED SWL =  $\frac{2}{3}$  x SWL MARKED









This inevitably means that in some cases the sling will be under-utilised. If maximum utilisation is required, then reference should be made to a person who understands the factors involved and can therefore perform the necessary calculations.

Notes:



## Mode Factors

As we looked at in Module 1 (Legislation), Mode Factors are used in order to rate lifting accessories. The Mode Factor is applied by the user (slinger or rigger) and takes into account the geometry of a sling assembly to obtain the maximum load it may lift for a particular mode of use. The following table is taken from the LEEA COPSULE, Table 1A5.1, page 1-42:

<b>MODE FACTORS</b> <b>Maximum load to be lifted = mode factor x SWL marked on the sling</b> <b>Key: NP = non preferred, NA = not applicable</b>								
1	2	3	4	5	6	7	8	9
Material	Single leg in line 	Single leg choked 	Single leg basket 	Single leg back hooked 	Single leg halshed 	Endless in line 	Endless Choked 	Endless basket 0-90° 
Chain	1	0.8	1.4	1	NP	NP	1	NP
Wire rope	1	0.8	1.4	1	1.6	NP	1	1.4
Webbing	1	0.8	1.4	NA	NP	1	0.8	1.4
Fibre rope	1	0.8	1.4	1	1.6	1	0.8	1.4
Roundslings	NA	NA	NA	NA	NA	1	0.8	1.4

## Rating of Lifting Accessories

Endless slings have fewer variations of use but it should be remembered that the slinging factor for endless chain and wire rope slings assumes choke hitch, whereas the standard rating for textile slings assumes a straight pull.

In all cases, it is also assumed that, at the points of attachment to both the lifting appliance and the load, the radius around which the sling passes are large enough to avoid damage to the sling. In the case of chain and wire rope endless slings, the rating takes account of the chain and wire rope being bent around itself on the bight.

For rating of other types of lifting accessories, we will visit each during the appropriate modules within this course.

## 11. WIRE ROPE AND WIRE ROPE SLINGS

Wire rope is a good medium for making slings, which are lighter than the equivalent capacity chain slings, and for use as winch wires and hoist ropes. It is capable of use at far higher speeds than chain. Due to its construction there are a large number of small wires at the surface and so it is more susceptible to damage than chain. Further, if a wire rope sling is bent around a corner of the load or repeatedly used to lift identical loads, the rope will take on a permanent set.



We will consider the construction of wire ropes and, in particular, BS EN 12385-4: 2002, Steel Wire Ropes – Safety – Stranded Ropes for General Lifting Applications, as this covers the construction of ropes used to make slings and used for most common hoist applications. We should just note here that other constructions of wire rope, for specific applications such as elevator ropes, are covered by other parts of BS EN 12385.

### Wire Rope

Wire ropes are made by spinning together a number of wires to form a strand; these strands are then spun around a core to form a wire rope. There are many constructions of wire rope. A variety of wire sections, wire diameters and methods of spinning the wires together are used to obtain very different rope characteristics, with different properties for specific duties.

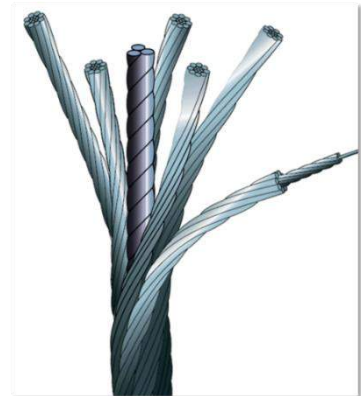

The more wires in a strand, the more flexible the resulting rope will be, with fewer wires the rope will be stiffer but more resistant to wear and damage.

### Strand Construction

For sling manufacture and common hoist applications, ropes formed from round section wire are used. Although slings and winch wires can be made from any suitable six or eight stranded ropes, six stranded are by far the more common. We will look at six stranded ropes, but note that exactly the same principles apply to eight stranded ropes.

Wire ropes are usually described by using a shorthand notation, starting with the size, then the number of strands, the number of wires in each strand and then the core.

e.g. **13mm 6 x 36 FC** is 13mm rope with 6 strands of 36 wires with Fibre Core

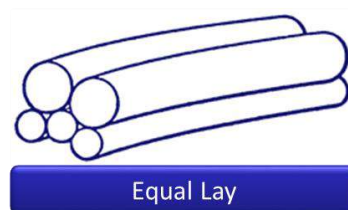
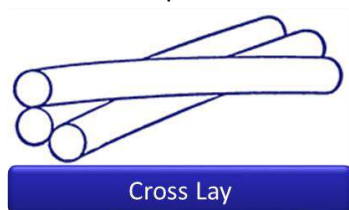

A strand is made from a number of single wires twisted together. A single wire, known as a **king wire**, is taken and then the remainder of the required number of wires are laid (twisted) around this to form a strand. There are two ways in which the strands in a rope can be laid up, Cross Lay and Equal Lay.

Note that BS EN 12385 refers to equal lay as parallel lay.

## Rope Construction

For small diameter slings, up to 13mm, the most common construction is 6 x 19 (6 strands of 19 wires) but as this would be too stiff for larger sizes, from 16mm to 48mm, the rope used is 6 x 36 (6 strands of 36 wires).

For slings above 48mm the construction is commonly 6 x 41 (6 strands of 41 wires).

The more individual wires in the same diameter rope will make the rope more flexible.

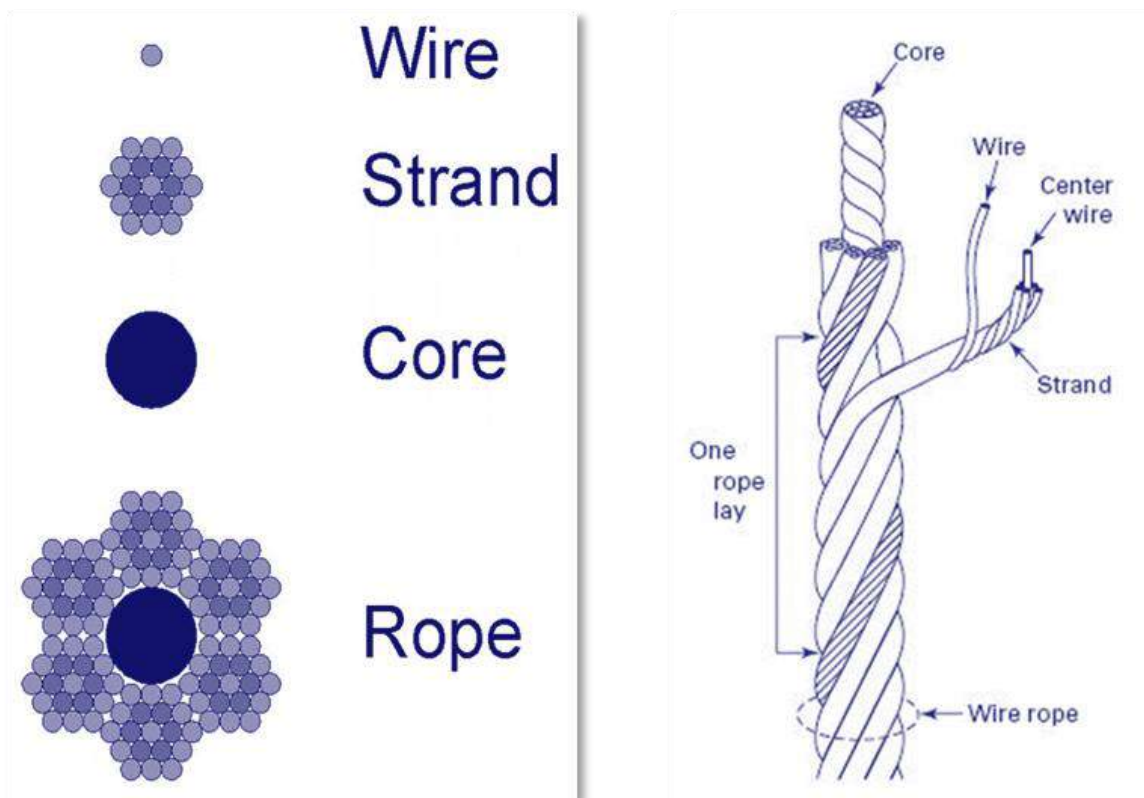

## Wire Rope Lay

### Cross Lay

Wire rope manufacturers began making wire ropes with wires of the same diameter; to do this they twisted the wires in two operations with the pitch of the helix in each layer being different. This is known as cross lay as the wires in each layer cross over each other.

In cross lay ropes high local pressure occurs between the wires due to their crossing over. This causes 'nicking', which will eventually lead to breakage and results in a rope with a relatively low breaking load. Their use is now very limited and none of the ropes we are concerned with in these studies are cross lay.

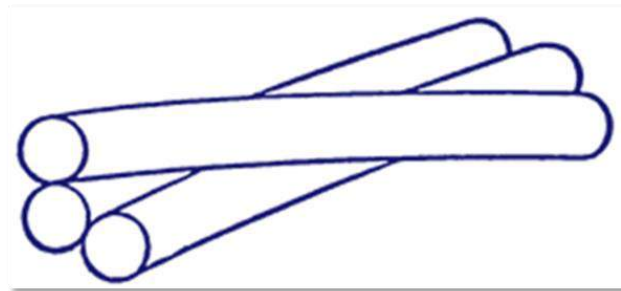

### Equal Lay

The problem of wires crossing one another is overcome by using wires of differing sizes to form the strands and to twist them together in one operation. Strands of this form are known as equal lay or parallel lay. The wires are laid together at the same length of lay so that the covering wires lay exactly along the valleys or crowns of the underlying wires. As a result, there is continuous line contact between adjacent wires.

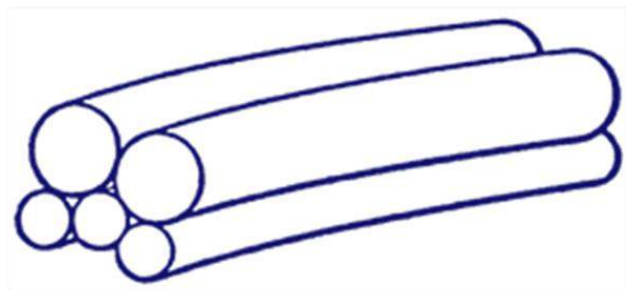

Notes:

## Wire Rope Strand Lay

There are three basic methods of laying up a strand: 'Seale', 'Filler' and 'Warrington'. A fourth, hybrid method is known as 'Warrington-Seale'.

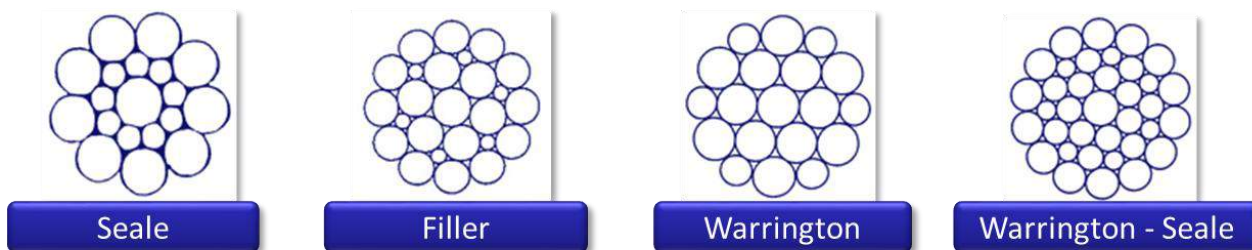

## Wire Rope Construction

### Seale Construction

A number of wires - nine in the opposite representation - are laid over a king wire. The same number of larger diameter wires is then laid in the valleys formed by the inner layer so the length of lay is exactly the same.

### Filler Construction

A number of wires - six in the opposite representation - are laid over a king wire. The same number of much smaller filler wires is laid into the valleys, thus doubling the number of valleys. Large diameter outer wires are then laid in the new valleys that have been formed, twelve in the illustration. The lay length of both the inner and outer wires will be the same.

### Warrington Construction

A number of wires - six in the representation opposite - are laid over a king wire. The same number of identical wires is laid in the valleys formed by the first layer of wires and a similar number of small wires are laid along the crowns of the inner wires. The lay length of both the inner and outer wires will be the same.

### Warrington-Seale Construction (or Combined Parallel Lay)

It is common practice to combine the attributes of the Warrington construction with that of the Seale construction. These ropes are commonly known as Warrington-Seale construction and are referred to in the BS EN 12385 series of standards as Combined Parallel Lay ropes.

The basic construction of the strand is Warrington laid with a further, outer, layer of large wires laid over the large and small wire layer so that each one lies in the valley between the alternate large and small wires.



# Wire Rope Strand Direction and Lay

## Direction of Strand and Rope Lay

**Lay direction of strand:** The direction right (z) or left (s) corresponding to the direction of lay of the outer layer of wires in relation to the longitudinal axis of the strand.

**Lay direction of rope:** The direction right (Z) or left (S) corresponding to the direction of lay of the outer strands in relation to the longitudinal axis of a stranded rope or the direction of lay of the outer wires in relation to the longitudinal axis of a spiral rope.

**Regular lay:** Stranded rope in which the direction of lay of the wires in the outer strands is in the opposite direction to the lay of the outer strands in the rope.

Right Hand Ordinary Lay is designated sZ and Left Hand Ordinary Lay is designated zS.

This type of lay is sometimes referred to as 'regular' lay.

**Lang's lay:** Stranded rope in which the direction of lay of the wires in the outer strands is the same as that of the outer strands in the rope.

Right Lang's Lay is designated zZ and Left Lang lay is designated sS.

## Wire Rope - Lang's Lay and Ordinary Lay

Wire Rope

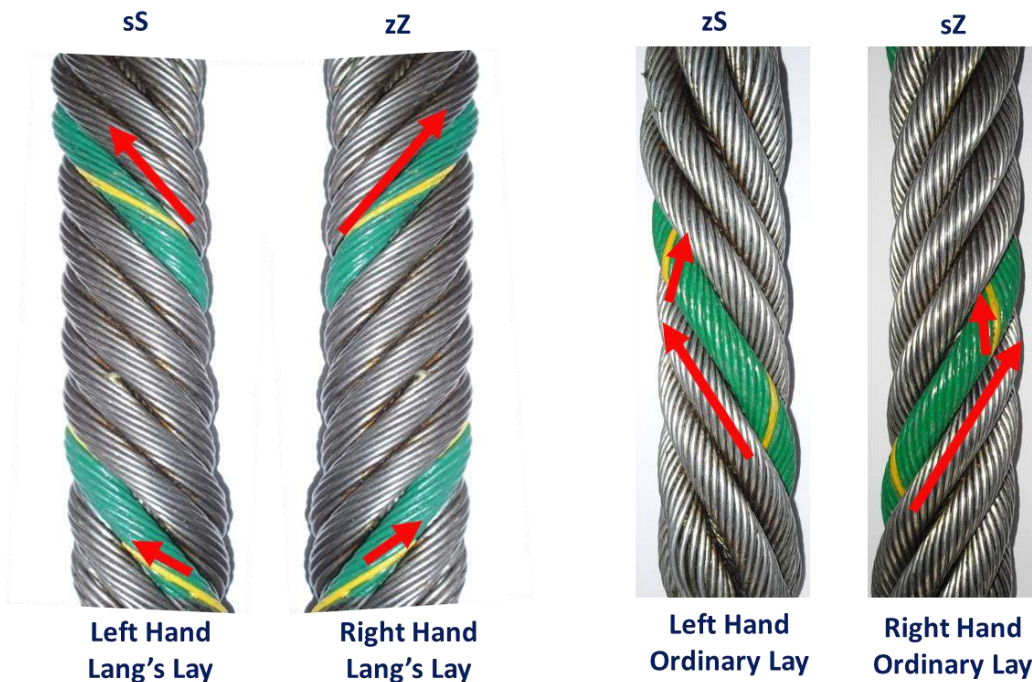

## Forming

### Pre-Forming

When both the strands and rope are being laid a process known as pre-forming can be applied.

If the strands and rope are made from straight wires, unless the free ends are seized with a suitable soft wire, they will try to straighten out. If a non-pre-formed wire rope is to be cut it must be seized both sides of where the cut is to be made or the cut ends will unravel and it will be unusable. Non preformed ropes have advantages for certain applications, but this one characteristic makes it difficult to handle during manufacturing. As a result, it is generally not used for this purpose.



Pre-Forming

## Wire Rope Grades

### Grade of Rope

Wire ropes are made in various grades, dependent on the tensile strength of the wire used in their construction.

- Rope grade 1770 is manufactured from wires with a tensile strength in N/mm<sup>2</sup> of minimum 1570 and maximum 1960
- Rope grade 1960 is manufactured from wires with a tensile strength in N/mm<sup>2</sup> of minimum 1770 and maximum 2160

These are the only two grades of wire rope used to manufacture general purpose slings and so consideration will be limited to these. Obviously the higher the grade, the stronger the wire rope will be.

## Wire Rope Finish and Coatings

The wires used to make wire rope are drawn to size from rolled steel rod. Wire drawing is a process of reducing the wire diameter in stages by drawing it through dies until the finished size is achieved. During this process, or immediately following this process, heat treatment and different protective finishes can be given to the wire.

A wire which is drawn will be smooth and will appear to have a slight shine to its surface. This is known as bright finish and a wire rope made from such wires is also known as bright wire. The surface will react with the oxygen in the atmosphere (oxidise) and will eventually rust. The speed of oxidation will depend on the conditions of storage and of use. Special dressings can be added to delay this in some applications.

Coatings and plating can be added to the wire during manufacture to provide protection from oxidation. The most common of these finishes is galvanising, where a surface coat of zinc is given to the wire.



BS EN 12385 uses the symbol 'U' to denote uncoated or bright finish. For zinc finishes the symbol will depend on the class of the coated finish. For example, class A zinc finish is designated 'A'.

## Wire Rope Slings

Wire rope slings are very popular for general lifting duties, however, they are more susceptible to damage than chain slings.

They have the advantage that, due to their rigidity, they can be easily passed under loads when slinging.

As with any lifting media, slings of all configurations can be assembled from wire rope and will be found in service. Those working in the offshore industry will be familiar with the 'five leg' slings attached to offshore containers. These are actually a four legged wire rope sling with a pendant sling attached to the master link. However, in general industry, by far the most common type of wire rope sling in service is the single leg.



## Standards

77

Wire rope slings are now manufactured to BS EN 13414-1: 2003, Steel wire rope slings – Safety – Slings for general service.

This is a harmonised European standard and replaces BS 1290.

The rating of slings in BS EN 13414-1 takes account of the termination efficiency before applying a factor of safety of 5:1.

BS EN 13414-1 calls for multi-leg slings to be rated and marked with their WLL expressed in terms of the inclination angle to the vertical (e.g. 0-45°)



The following standards are also relevant:

- BS EN 12385** - Steel wire ropes – Safety
- BS EN 13411** - Terminations for steel wire ropes – Safety
- BS EN 1677** - Components for slings – Safety

## Single Part Leg

A single part leg is the leg of a sling formed by a single part of wire rope.

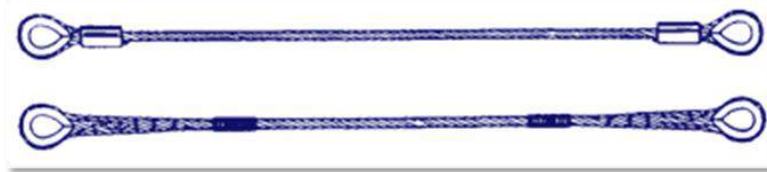

## Double Part Leg

A double part leg is the leg of a sling formed by two parts of wire rope when constructed as a grommet, spliced endless or ferrule secured endless with the two parts in parallel contact having a thimble seized at each end.

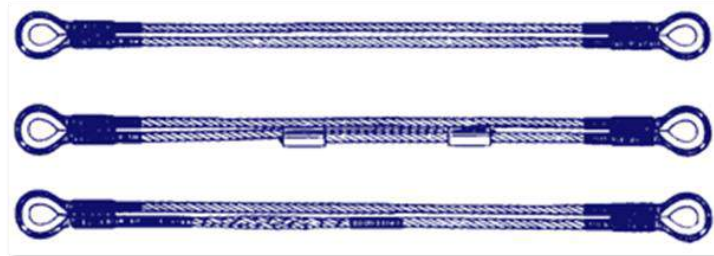

78

## Thimble Eyes

### Thimbles

A thimble is a protective insert which is fitted to the eye of a sling leg at the time of manufacture.

Thimbles are fitted where it is desirable to protect the eye from the worst effects of abrasion and point loading.

Two common types of thimble are used in the construction of slings. The **teardrop shaped thimble**, which is used where sling legs are to attach to other fittings, and the **reeving thimble**, which is designed to permit the passage of one eye through the other so that the sling may be used in choke hitch. A similar protective inset, known as the stirrup or half thimble, is designed to protect the wire rope of a soft eye when the sling is used in choke hitch.



## Hand Spliced Eye

A hand spliced eye is an eye formed at the end of a sling by the traditional method of threading the individual strands of the rope back along the main body of the rope in a prescribed pattern.



Whilst this type of eye is now less popular than the more modern ferrule secured eye, it is still available and preferred by some users.

## Common Sling Assemblies

The most commonly used wire rope sling assemblies are illustrated in this subsection of the code. Other special assemblies may be devised for lifting specific unusually shaped loads. Sling legs may be single part or double part with hand spliced or ferrule secured eyes.

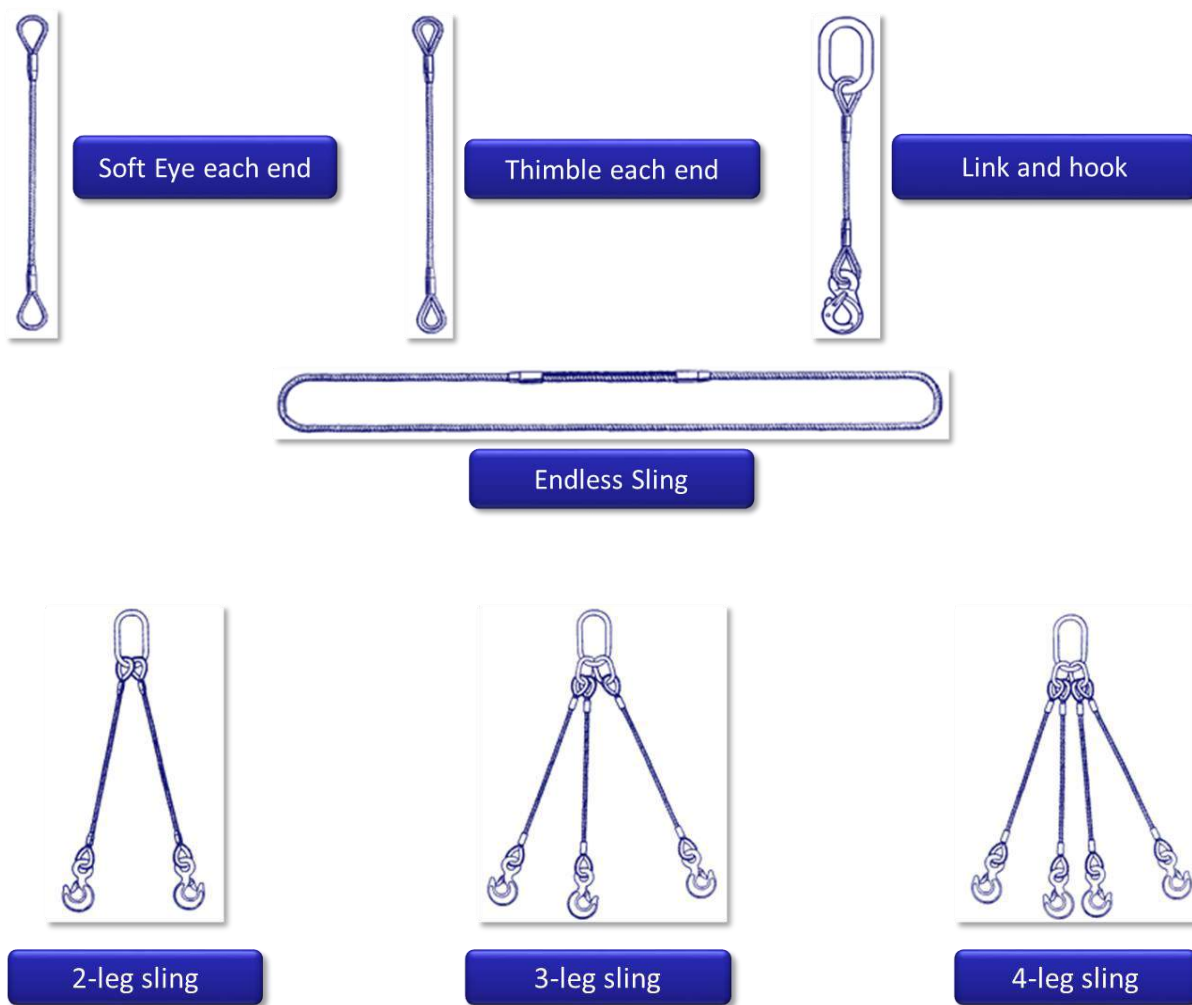

## Terminal Fittings

A range of terminal fittings are available for wire rope slings. Here are a few examples:



Shackle



Master Link



Hook



C Hook

## Eye Terminations

There are two ways that eyes can be made, ferrule secured (sometimes incorrectly referred to as a mechanical splice) and hand spliced.

BS EN 13414-1 does not specify how to make these eye terminations, but requires them to be made in accordance with BS EN 13411-2 and 3.



The Turn Back Loop



The Flemish Eye

### Turn Back Loop

The turn back loop is the cheaper option to manufacture and therefore is perhaps used more commonly for general purpose slings. With this method, an aluminium ferrule is used to secure the eye made in the end of the rope.

The eye is simply formed by passing the ferrule over the rope, bending the rope back on itself to form the eye, pulling the ferrule back over the returning tail end of the rope and then pressing the ferrule. Under pressure the aluminium flows into the rope formation, making a homogeneous joint.



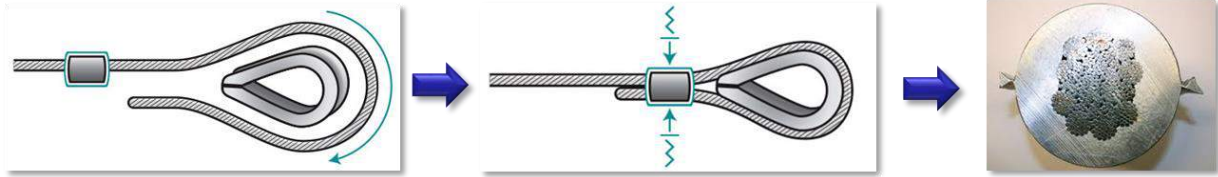

### Ferrule Secured Eyes

When square cut ferrules are used, in order to ensure that the rope is fully engaged within the ferrule it is necessary for a small amount of the tail to protrude through the ferrule. The standard says that the length of this should be no more than one half of the rope diameter. However, if the rope has been cut by a heat process a portion of the rope will have become annealed (softened) in the heat affected area. The protruding tail in this case should be no more than an amount equal to one diameter of the rope, and positioned so that none of the annealed section is within the ferrule.



### Tapered Ferrules

Tapered ferrules are also available from some manufacturers. In this case the tail end remains within the ferrule and it is essential that the ferrule manufacturer's instructions for fitting are followed. Often, the manufacturer of the ferrule will provide a small view hole in the ferrule to enable the tail end to be seen.

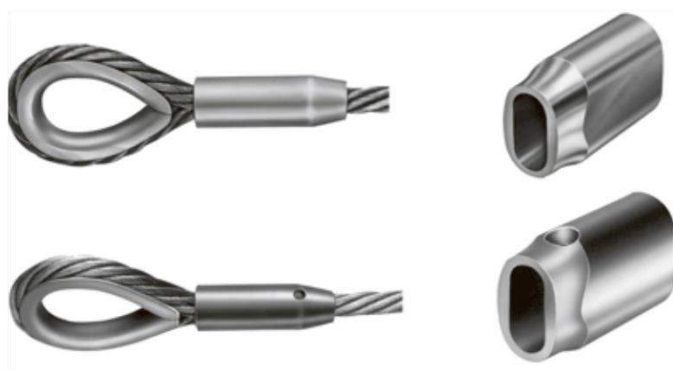

## Soft Sling Eyes

A simple loop in the wire, with no protective thimble, is known as a soft eye. BS EN 13411-3 requires the length of the soft eye ( $h$ ) to be at least fifteen times the diameter of the rope and the width ( $h/2$ ) to be half the length of the eye.

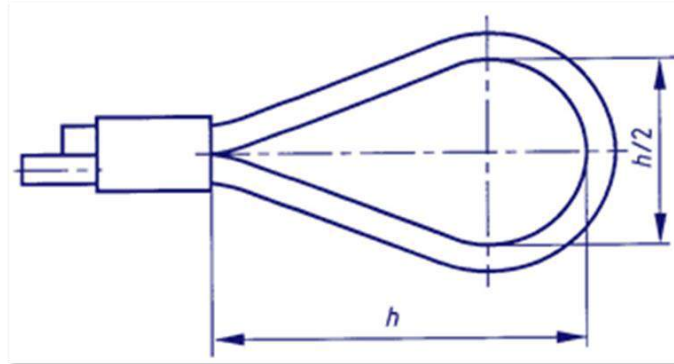

## Flemish Eye

A tapered steel ferrule is passed over the rope. The standing part of the rope is then taken and three strands are unravelled and opened so that a 'Y' formation is made. Care has to be taken to ensure that the strands still lay together as they had in the rope.

The leg of the 'Y' that includes the core is bent to form an eye so that the ends of the strands sit against the undisturbed part of the rope at the bottom of the 'Y'. The remaining three strands are then re-laid into the rope in the opposite direction, taking up the position they originally had in the rope so that the lay of the strands is not disturbed.

The ends of the strands are then evenly distributed around the intact standing part of the rope to complete the eye. The ferrule is then slid back over the distributed wires without displacing the strands and then pressed. In this case the ferrule compresses and grips the rope.



Notes:

## Stirrups

The minimum peripheral length of a soft eye should be four times the rope lay length. This is so as to ensure that the lay of the rope is not disturbed.

It is extremely difficult to fit thimbles when making Flemish eyes. If the sling is to be used in a choked situation then a protective attachment, known as a stirrup thimble, is commonly used to protect the rope from damage.

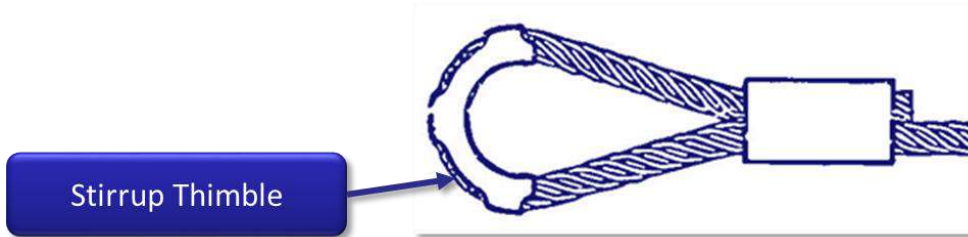

## Hand Spliced Eyes

Hand splicing is the old method of making eyes in wire ropes, and slings with spliced eyes were once common. Slings with spliced eyes can occasionally be found in service. The requirements for spliced eyes are given in BS EN 13411-2.

83

The rope is bent to form an eye. The strands in the end of the rope are separated and then tucked back into the standing part of the rope against the lay. This is done in such a way that they lock and do not slip when a load is applied. There must be at least five load carrying tucks. At least three of these must be made with the full strand and the remaining tucks with at least 50% of the wires. This is known as a 'Five Tuck Splice' or sometimes as a 'Docks Splice'.





## Five Tuck Splice

A well-formed 'five tuck' splice will tighten into the rope when a load is applied, which increases the efficiency of the splice. The tester and examiner must however be alert to a form of splice, known as the 'Liverpool Splice'. In a Liverpool Splice, the strands are tucked into the body of the rope with the lay and it will open up and release the load if the rope or load is allowed to rotate. The 'five tuck' splice is therefore the only type of splice acceptable for lifting applications.



The Five Tuck Splice

## Wire Rope Grips

For many years it has been common practice to make temporary eyes in wire rope, particularly winch wires, by using clamp type grips, commonly known as bulldog grips.

This practice has always been questionable as the safety of the resulting eye has depended on several variable factors, i.e. the number of grips used, the spacing of the grips, which way round they are fitted and their tightness. These factors are heightened by the fact that a wide range of types and patterns of grip are freely available on the market and have often been fitted by untrained persons.



## Single and 2-Part Wire Rope Slings

Although not mentioned in BS EN 13414-1, another method is sometimes used to produce sling legs, known as two-part sling legs. It is not a very common way of producing sling legs, but is used for very large capacity slings, so the tester and examiner needs to be aware of it. An endless sling is produced, as above, and then a thimble is bound at each end, as shown below:

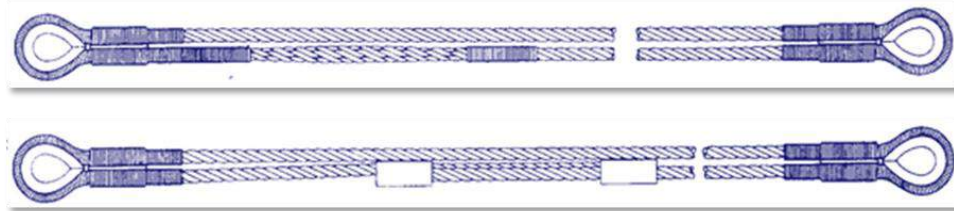

The thimbles that are used must be two or three sizes larger than would normally be used for the rope diameter. The looped sling leg will take a greater load than a single part sling made from the same size rope and a thimble for the actual rope diameter would collapse under the increased load it has to take. In order to make the thimble fit the rope it is necessary to serve the rope with wire or spun yarn.

A sling leg produced by this method is not capable of twice the WLL of a single part of the rope, as one might expect, but is in the order of 25% less than this. This is due to the increased stress due to the rope being bent around such a tight radius.

As this method of producing sling legs is not covered by standards, the manufacturer must produce a full technical file in order to comply with the requirements of the Machinery Directive. Their instructions for use, maintenance and examination must be sought and followed.

85

The British Standard BS EN 13411 Terminations for steel wire ropes Part 5:U-bolt wire rope grips was introduced in 2003. This standard gives the fitting instructions, torque and number of grips required and the safety requirements for the use of wire rope grips.

## Rating of Wire Rope Slings

Multi-leg wire rope slings to BS EN 13414-1 are rated by the uniform load method.

It was also the method used for slings to BS 1290; however, the way of expressing the WLL is different. BS 1290 adopted the UK traditional way of expressing this as SWL at the included angle (e.g. SWL 1t 0-90°), but BS EN 13414-1 expresses it as WLL at the inclination angle to the vertical, (e.g. WLL 1t 0-45°)

As mentioned at the start of this unit, BS EN 13414-1 gives the WLL for the made up slings which takes the efficiency of the splice or joint into account before the WLL is calculated. This was not the case with BS 1290 which merely applied the 5:1 FOS to the breaking load of the rope.

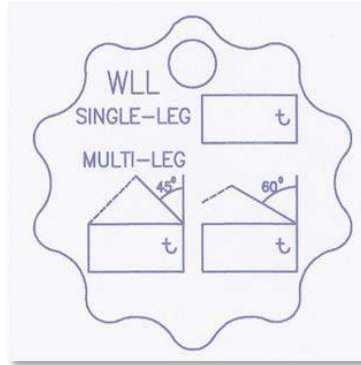

## Verification of Wire Rope Slings

BS 1290 required the sling manufacturer to carry out a proof load test on all sling legs, other than spliced legs, at twice the WLL. In real terms this was a rather pointless test; a badly made ferrule secured eye, or even one using the wrong size ferrule, would often hold the proof load.

BS EN 13414-1 has a very different, but perhaps more meaningful, verification regime relating back to the other standards used. The rope must be confirmed as being the correct construction, diameter and grade and this must be checked against the rope supplier's documentation. The WLL of links and terminal fittings must be checked against the supplier's documentation to verify the correct WLL and grade. The ferrule secured eyes or splices must be checked in accordance with the respective standard covering them.

86

In the case of ferrule secured eyes, BS EN 13411-3 requires the verification of ferrules and ferrule secured eyes to be made at various stages.

1. The correct selection of the ferrule for the particular rope size must be checked against the ferrule manufacturer's instructions and documentation
2. The forming of the eye must be checked against the requirements of the standard by visual examination and measurement
3. The pressing of the ferrule is verified by visual examination and the finished dimensions of the ferrule confirmed against the manufacturer's instructions and a table given in the standard

The dimensions of an un-pressed ferrule are known and matched to the appropriate pressing dies and wire rope size. It is therefore known what the correct dimensions of the pressed ferrule will be. If the wrong size ferrule and/or dies are used, the length and diameter of the pressed ferrule will vary. Checking this way is a far better way of ensuring the joint has been made correctly and will be capable of entering service safely than putting a load on which might not reveal these matters.

## Manufacturer's Documentation

In the case of a new sling, the manufacturer is required to supply documents in accordance with relevant legislation and relevant standards:

- EC Declaration of Conformity (LEEA 047 version 2 dated 23 February 2015)
- Manufacturers Certificate (guidance EN 13414 -1, -2, -3)
- Manufacturer's instructions for use. (guidance SI.2.3)

**Note:** the EC Declaration of Conformity and Manufacturers Certificate can be issued as a single document.

## Manufacturer's Documentation and Marking Requirements

### Manufacturers Certificate

The certificate shall contain at least the following information.

- The name and address of the manufacturer or where applicable the authorized representative
- The number and part of this European Standard; i.e. EN 13414-1
- The description of the sling including all component parts
- The WLL and the appropriate angle(s) to the vertical for multi-leg slings
- The static test coefficient(s) used for design of component(s) (e.g. hook; link; shackle)

### Markings

There are multiple markings that have to be present on a wire rope sling. We will study this subject in the LEEA Lifting Equipment General Advanced Programme.

Notes:

## 12. CHAIN AND CHAIN SLINGS

Steel chain is a very common product that is generally 5 to 6 times heavier than wire rope. Chain also tends to have a longer working life than that of wire rope as it is very robust and is less susceptible to damage in use.



### Chain

The first stage of manufacturing load chain is to draw a bar of steel through a die, compressing it and thereby increasing its strength.

Once the bar has been drawn to the desired dimension and strength, it is stored on spools ready for use in the chain manufacturing production line.

Chain is then made by passing lengths of steel bar into a machine that uses a series of automated processes to shape, form and weld each link into the finished chain.

Following welding, the chain will undergo a process of heat treatment to achieve the desired material properties such as strength, ductility and toughness.

Once the chain has been tested it is issued with the manufacturers documentation and placed in controlled storage ready for dispatch.

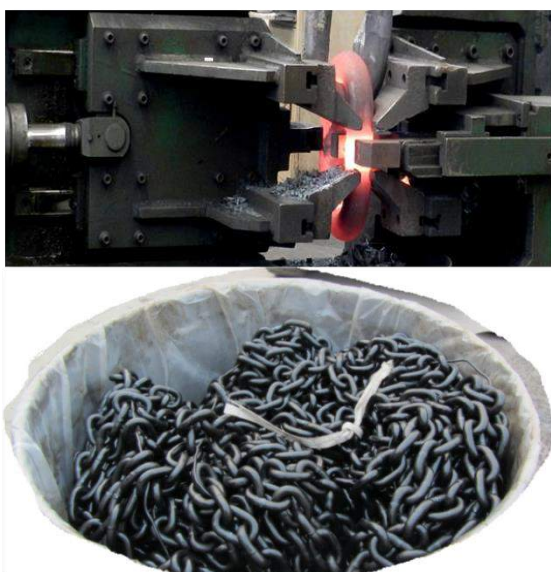
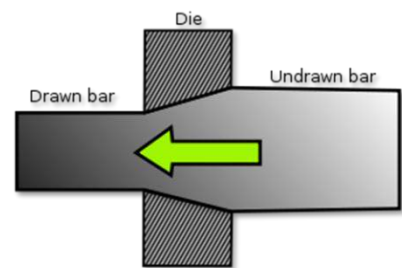



## Chain and Chain Sling Standards

The first sections of BS EN 818 were introduced into the UK during 1997. The final part of the standard was issued in 2002.

BS EN 818 is the harmonised European Standard for chain and chain slings. It has been prepared to enable manufacturers to demonstrate that they are meeting the essential safety requirements of the European Machinery Directive and reflects the state of the art.

- Chain intended for use in chain sling assembly is graded using numbers
  - BS EN 818 currently uses grade 4 and 8 steel for chain manufacture
  - The grade of chain intended for sling manufacture formerly known as grade T is now grade marked 8
  
- Chain intended as load chain for lifting appliances is letter graded
  - BS EN 818-7 covers grade T chain (calibrated chain as it was previously known) of three types: T, DAT and DT

## Medium and Fine Tolerance Chain

Medium tolerance chain, intended for sling manufacture, needs to be more ductile to withstand shock loading. However, in use it is not subject to wear and can therefore have a softer skin. As it does not mate with other, moving, parts it does not need to have such a precise pitch.

89

When chain is produced by machine the links are marginally misshapen, the sides having a slight curve. When the manufacturer 'calibrates' it by the application of a force, the links bed down on each other and the sides of the link straighten. As a result the chain extends by a marginal amount.

In the case of load chains it is vital that the links are of precise size and form so that they engage correctly in the pocketed load wheels of the appliance. This is achieved by manufacturing the chain to a calculated undersize. The finished chain is then subjected to an increased force, which pulls it to the required even shape, size and pitch.

Various finishing treatments are then given to fine tolerance chain to increase its wear resistance (e.g. case hardening). The loss of some ductility due to the manufacturing and finishing processes is relatively unimportant for load chains. However these features are undesirable in a sling chain where it is less likely to wear. Sling chain is more liable to be shock loaded, so good ductility is essential.

Fine tolerance chain may be recognised in two ways. The calibrating process has the effect of removing all of the residual scale from the heat treatment process and many of the finish treatments include corrosion resistant finishes. As a result it has a bright finish and of course there is also the grade mark.

**Note:** Slings made in the UK between 1981 and 1997 may show the letter 'T' as a grade mark. Students should therefore make themselves familiar in the recognition of fine tolerance and medium tolerance chains by looking at as many examples as possible.



Medium Tolerance



Fine Tolerance

### Medium Tolerance

Medium Tolerance chain is used only for chain slings.

In accordance with BS EN 818-4 and 818-5, the grades used are 4 and 8.

Grade 4 chain slings are covered by BS EN 818-5

Grade 8 chain slings are covered by BS EN 818-4

Medium Tolerance chain is more ductile than Fine Tolerance chain and tolerates a degree of shock loading.

### Fine Tolerance

Fine Tolerance chain is used only for lifting appliance applications (hoists)

In accordance with BS EN 818-7, the grades used are T, DT and DAT.

Fine Tolerance chain is less ductile than Medium Tolerance chain.

Notes:



## Manufacturer's Test Requirements

Each of the British Standards specified the proof load/force that had to be applied by the chain manufacturer.

Following the completion of all of the manufacturing processes, chain manufacturers test the chain and issue a master test certificate. This also gives the traceability back to the production, heat treatment and finishing batch. They also carry out random tests to destruction, by tensile loading, bend test and by fatigue testing to ensure the properties and qualities of the finished chain have been achieved and remain consistent.

In the case of grade 8 Medium Tolerance chain, the manufacturers test force is higher than the customary 2 x WLL. It is actually set at 2.5 x WLL. It is intended that this is the initial test, which is not repeated.

The proof load for Fine Tolerance load chains is set at different percentages due to their duties.

## Manufacture of Chain Slings

At one time certain types of chain sling were made from, or included, long link chain. It should be noted that the European Machinery Directive only permits the use of short link chain for lifting purposes. The use of long link chain is therefore prohibited.

91

Modern chain slings are assembled from components which have mechanical fixings, such as spiral roll pins, to retain them. Older chain slings, and currently a few for special applications, were assembled by a blacksmith and had welded joining links.

Although, in theory, both methods of assembly may be applied to any grade of chain, in practice it will be found that only grade 4 are generally produced by welding and grades 8 by mechanical assembly. In certain circumstances grade 8 welded slings may be produced, but their use is rare.

## Welded Assembly Chain Slings

- Extremely rare to find in service
- Usually supplied where higher grades of chain cannot be used
- Standard chain is used and a blacksmith will use welded joining links to attach a range of fittings (e.g. hooks, rings and links)
- The welding method used is Atomic Hydrogen
- Heat treatment is necessary after manufacture as the material structure of the components is affected by the welding process
- Each sling is then tested on completion of manufacture or repair
- Grade 4 chain to BS EN 818-3 is used for welded assembly chain slings
- Suitable for use in high temperature and acidic environments where grade 8 cannot be used due to softening and hydrogen embrittlement (we will look at this in more detail in the Lifting Equipment General Advanced Programme training course)



## Mechanical Assembly Chain Slings

- For well over 30 years now nearly all of the chain slings supplied in the UK have been mechanically assembled grade 8 (originally known as grade T)
- Although not yet covered by the standards, grade 10 has entered and established itself in this market
- Can be assembled and repaired easily and quickly
- Standard master links and an extensive range of fittings are available which can be assembled onto chain quickly using special couplers or clevis and load pin arrangements on the component itself
- BS EN 818-4 covers Grade 8 mechanically assembled chain slings
- Fittings for mechanically assembled slings are available in many types, all covered by BS EN 1677



92

## Chain Sling Fittings

- A full range of fittings is available with the clevis form of chain connection, such as hooks, shackles and egg links
- This system of assembly minimises the number of components necessary to assemble a sling, as the terminal fittings locate directly onto the chain
- For the connection of the chain to master links a simple shackle like coupler is available in some systems
- With clevis attachment the end link of the chain is passed into the jaw of the clevis
- A load pin is passed through the clevis and chain, on which the chain seats
- Spiral roll pins or circlip type fixings are used to lock the load pin in position

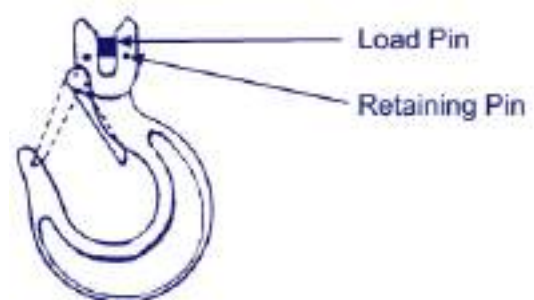

## Coupling Assembly



- Some systems employ fittings with large eyes through which half a coupler is passed; the other half of the coupler is passed through the end link of the chain. Couplers are available for chain to chain, chain to eye type fitting and chain to master link attachment
- The two halves of the coupler fit together and a locking/load pin passes through the centre to hold them together
- The locking pin is kept in position by a central retaining collar, spring clips or circlip type fixings
- The general assembly procedure is shown opposite
- Students are advised to obtain as many different manufacturers catalogues as possible and study the range of fittings available as well as the assembly methods employed

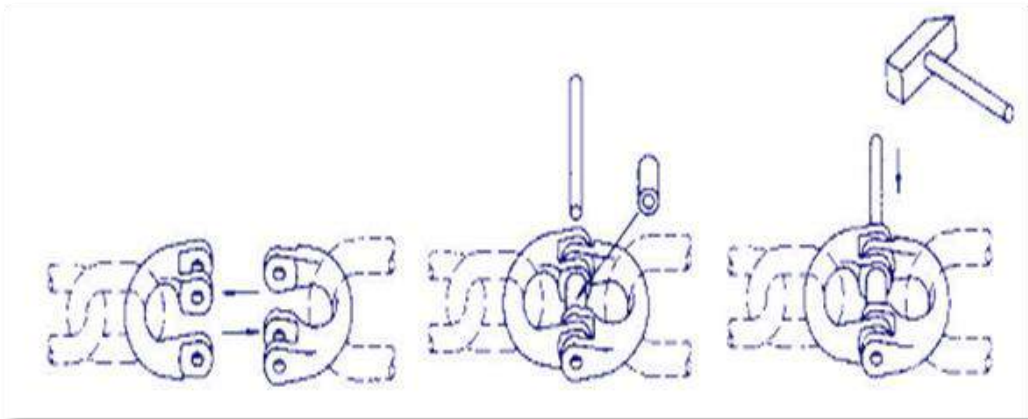

Mechanically assembled chain system components are supplied by the system manufacturer in the hardened and tempered condition. As the assembly of the sling does not affect the material condition no further heat treatment is necessary, indeed it would be dangerous to do so.

The components are also verified by an appropriate method and certified by the manufacturer. Assembled slings do not therefore need to be proof tested, but only thoroughly examined to ensure that they are correctly assembled and that no damage has occurred during handling and assembly. Indeed, with a system in compliance with the relevant standards, it is not possible to test a made up sling without damaging it beyond use.

Notes:

## Rating of Chain Slings

There are two methods of rating multi-leg slings, the trigonometric method and the uniform load method.

Older general purpose slings may occasionally still be found rated by the trigonometric method. However, since the publication of BS 6166 in 1986, it should be reserved for use on single purpose slings, i.e. slings that will and can only be used in one way, such as the top chain of a spreader.

The uniform load method should be used for all general purpose slings. Whilst this has been the recommendation since 1986 the practice has not always been followed.

**The uniform load method is the only method specified for general purpose chain slings in BS EN 818-4, therefore they must be rated this way.**

We will visit the topic of rating chain slings in further detail in the Lifting Equipment General Advanced Programme training course.

## Manufacturer's Documentation for Chain Slings

### Manufacturers Certificate

The certificate shall contain at least the following information.

94

Each assembled chain sling shall be provided with a dated certificate stating conformance with EN 818-4 and giving a least the following minimum information:

- Name of the chain sling manufacturer or supplier including date of issue of the certificate and authentication
- Number and part of the standard, e.g. EN 818-4 or EN 818-5
- The identification number or symbol of the chain sling
- A description of the chain sling, to include a list of all component parts
- The nominal size of the chain and the grade mark
- The nominal length
- The working load limit

For chain slings of **welded construction** the following information is required in addition to the minimum information above:

- The value of the manufacturing proof force(s) applied
- The name of the person or establishment that carried out the manufacturing proof force test and final examination

For chain slings **joined by mechanical devices** the following information is required in addition to the minimum information above:

- In the case of chain slings proof tested following assembly the following information:
  - The name of the person or establishment that carried out the manufacturing proof force test and final examination
  - The value of the manufacturing proof force applied
- In the case of chain slings not proof tested following assembly, the name of the competent person or establishment that carried out the visual examination

## Markings

### Marking Requirements

Markings should appear every 20th link, or at intervals of 1 metre (3ft in the case of the imperial standards), whichever is the lesser distance. The links must be stamped or embossed on the least stressed part of the chain - the side of the link opposite the weld. If stamps are used to mark the chain they must have a concave surface and the indentation should be such that it does not impair the mechanical properties of the chain link.

The grade mark indicates both the material from which the chain, or item, is made.

The chain sling details may be marked on the main ring or master link. Often this is not practicable, in which case it should be on a tag fitted to the upper terminal fitting in such a way that it does not obstruct the free movement of any part of the sling or become damaged when the sling is in correct use. If the latter method is used, the identification number of the sling, which is traceable to the records, should also be marked on the upper link or ring so that if the tag is lost the information can be retrieved.

We will look at marking requirements in further detail during the Lifting Equipment General Advanced Programme training course.

Notes:

## 13. TEXTILE SLINGS – FIBRE ROPE AND FIBRE ROPE SLINGS

Very few fibre rope slings are used nowadays in the UK. This is due to their bulk and the fact that reliable flat woven webbing slings and roundslings are readily available, easier to handle and are far more convenient to store. They are still used to some degree within Europe and the rest of the world.



### Fibre Used for Textile Slings

Fibre rope slings can be produced from man-made fibres and a limited range of natural fibres.

Textile slings are manufactured from three man-made fibres: Polyamide (nylon), Polyester and Polypropylene. Additionally, fibre rope slings may also be produced from manila, sisal and hemp, which are natural fibres.

New, specialist man-made fibres are now being used to produce specialised lifting slings, this has high cut and abrasion resistance, the manufacturer's advice should be obtained if the examiner are asked to inspect such slings. Although the various fibres have many common features, they react differently to temperature, chemical contact and environment.

### Effects of Temperature

Polypropylene, manila, sisal and hemp fibres are suitable for use in the temperature range  $-40^{\circ}\text{C}$  to  $80^{\circ}\text{C}$ .

Polyester and polyamide are suitable for use in the range  $-40^{\circ}\text{C}$  to  $100^{\circ}\text{C}$ .

If man-made fibres are used at higher temperatures than those given they will at first soften, begin to melt and fuse together. As the temperature rises they will char, becoming brittle and burn. Natural fibres will simply become brittle, char and burn.





## Chemical Resistance

Natural fibres have no resistance to chemical attack; however, the various man-made fibres have selective resistance to chemicals as follows:

- Polyamide is immune to the effects of alkalis, but is attacked by acids
- Polyester is resistant to acids but damaged by alkalis
- Polypropylene is little affected by acids or alkalis but is damaged by solvents, tars, paints etc.



## Ultra Violet Radiation

All textile fibres become brittle as the result of exposure to sunlight or other sources of ultra-violet radiation. This is known as solar degradation. Its effect is more pronounced in man-made fibres, but it is hard to detect until at an advanced stage. Then, very quickly, they will become brittle, turn to powder and crumble away.

During the manufacturing stage man-made fibres, intended for use in sling manufacture, are subject to a process known as stabilising. Whilst this does not prevent solar degradation it does slow down the rate of this effect.

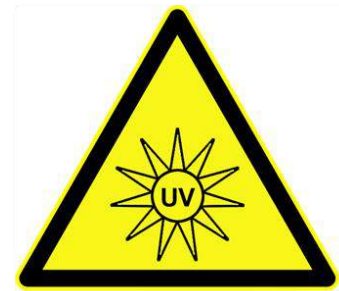

## Effects of Water

Natural fibres do not behave well when wet. There is a general, but small, loss of strength. They absorb the moisture and this increases their weight, making them more difficult to handle. Also, when the materials become wet, it will speed the natural rotting process. Unless dried and handled carefully they will be attacked by mildew, visible as black spots and staining, which will grow on the fibres and live on the cellulose, weakening the fibre. This also occurs if natural fibres are stored in damp, musty, conditions and this greatly shortens their life.



Man-made fibres do not suffer this way, as mildew will not grow on them. If any is found, it is growing on surface contamination which will have no effect on the fibres, and can usually be washed off with clean water. However water does affect manmade fibres in other ways:

- Polyamide loses about 10% of its strength when wet
- Polyester and Polypropylene is unaffected by water and therefore its strength remains unchanged when wet



## Elongation

Natural fibres have little elongation under load. However, because of the way a rope is made, a fibre rope sling will stretch when put under load as the fibres and strands bed down in the rope.

Man-made fibres elongate considerably more:

- Polyamide is highly elastic and stretches as much as 40% under load
- Polyester only stretches by approximately 5%
- Polypropylene stretches by varying amounts, usually less than Polyamide but more than Polyester

As well as being elastic, man-made fibres also have plasticity and some permanent elongation occurs every time that they come under load. Whilst this permanent elongation is small, a man-made fibre sling actually becomes slightly longer every time it is used.

## Material Identification

Visually, the various man-made fibres appear much the same. This makes identification extremely difficult. An international system of colour coded labels, which carry the information necessary to be marked on a sling (see marking), has therefore been adopted in standards as follows:

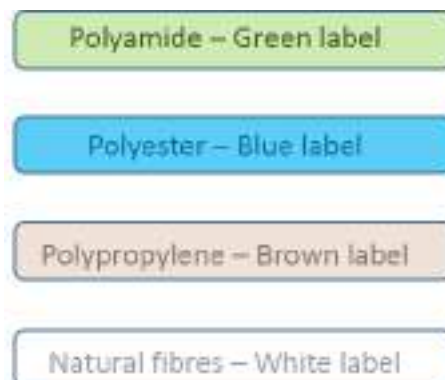

Notes:

## Fibre Rope Slings



Although the natural fibres can be recognised visually when new, when they have been in use and become soiled it is difficult to tell one from another. It is considered that their use for slings is now rare, so the sling standards ask only for the material to be stated on the label.

Although their popularity has declined greatly in modern times, in favour of more convenient forms of sling such as webbing and roundslings, a few remain in service.

Fibre rope slings are manufactured to BS EN 1492-4 – Textile slings – Safety – Lifting slings for general service made from natural and man-made fibre ropes. The standard covers slings made from ropes of Polyamide, Polyester, Polypropylene, manila, sisal and hemp. The slings are produced from cut lengths of 3, 4 or 8 strand rope which are then hand spliced. They are bulky to handle and natural fibres, in particular, are rough to the touch. Rope slings are less pliable than other types of textile sling and, unlike other textile slings, they present a hard point contact with the load. However, this is still less severe than with chain or wire rope.

## Fibre Rope Construction

Fibre ropes are spun in much the same way as wire ropes. A rope is made by spinning the fibre yarns together to form a tight strand and then spinning a number of strands, usually 3, to form a rope. In the case of man-made fibres another method is to make smaller diameter strands and then plait them to form a rope. Any one of these three constructions of rope can be used to make slings, although 3 strand is the most common.

The more strands in the rope, the more flexible the rope will be. However rope is far less pliable than webbing or roundslings. The illustration below shows a 3 strand and an 8 strand plaited rope:

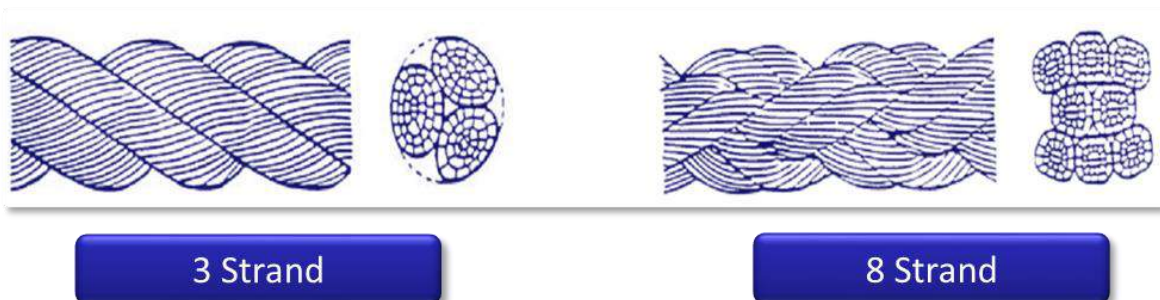

## Fibre Rope Sling Construction

Single leg, multi-leg or endless fibre rope slings can be produced. They are made by hand splicing eyes at each end of a piece of rope or by splicing one cut end of a rope to the other end forming an endless loop. In the case of multi-leg slings, the eye one end of each sling leg is made through a master-link. Where this is done the use of thimbles is advised to protect the eyes.

Eyes are produced by bending the rope to form a loop. The strands in the end of the rope are separated and then tucked back into the standing part of the rope against the lay to form the eye, in a similar way as with wire rope. This is done in such a way that they lock and do not slip when a load is applied. There are differences in the splicing requirements, depending on the type of rope used. This is due to differing coefficients of friction.

It is important that the splicing tucks are made against the lay of the rope. The 'Liverpool splice', where the tucks are with the lay, is prohibited. This is because if the rope is allowed to spin or turn under load, the splice will unravel itself. The illustration below shows a spliced eye with thimble.

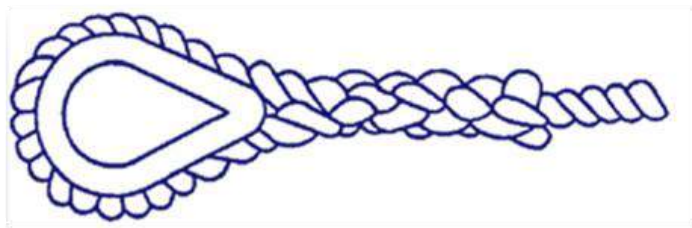

In the case of 8 stranded ropes, splices must be made fully in accordance with the rope manufacturer's instruction, which must be sought and followed. For 3 or 4 stranded ropes the standard makes the following requirements for splicing:

- **Polyamide ropes, Polyester multifilament ropes and Polypropylene monofilament ropes:** either five full tucks or four full tucks with all of the yarn followed by a further tuck with at least 50% of the yarn and a final tuck of not less than 25% of the yarn
- **Polypropylene fibrillated film and staple ropes and natural fibre ropes:** not less than four full tucks

In the case of endless slings, the splicing requirements above must be made each side of the marrying point.

## Manufacturer's Verification

The splices produced by each person will vary in efficiency to some degree. Therefore, BS EN 1492-4 requires the manufacturer's type tests to be made for each splicer as well as for each size and type of rope and each splicing method used. These tests are made on specially produced test pieces, which must sustain a force equivalent to 7 times the WLL. In the case of endless slings, the force is equivalent to 5 times the WLL.

Similar tests are made periodically from slings selected from the manufacturing batch to ensure no unexpected changes have taken place. If the specimen fails to sustain less than 90% of this force a further three samples must be selected for test. If any one of these fails, the test the batch must be rejected. All slings produced must be visually examined.



## Marking Requirement

The required marking must be on an appropriately coloured label, signifying the material from which the sling is made. The marking must give at least the following information:

- Identification mark
- WLL
- Material of the rope
- Size of the rope and the sling length
- Grade of any fittings
- Manufacturer's name
- Any marking required by legislation (i.e. the CE mark)

One of the best ways of attaching the label to rope slings is to place them around the rope and cover them with a heat shrink clear plastic sleeve. This requires the sleeve to be passed over the rope prior to splicing.

Notes:

## 14. TEXTILE WEBBING SLINGS

Flat woven webbing slings may be made from a single thickness of suitable webbing (simplex) or two layers of webbing (duplex). Unlike steel products, the initial tensile strength of the webbing is affected by several factors and these are outside of the sling manufacturers' control. BS EN 1492-1 therefore refers to the 'sewn webbing component' as being the basis for calculating the WLL.

The standard also requires that all of the material and stitching yarn, and the eye reinforcement if it is textile, are of the same man-made fibre. This is due to the varying properties of the different fibres.

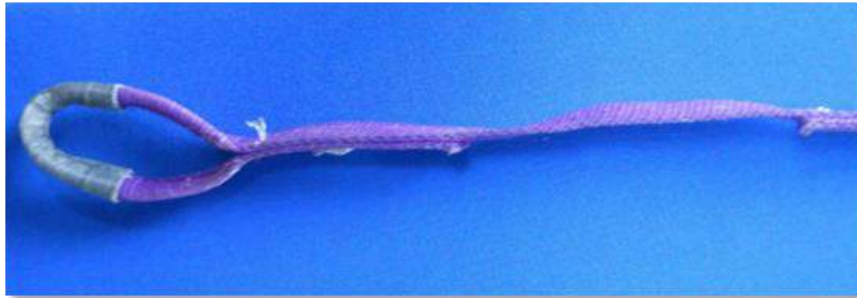

Simplex



Duplex

### Fibre Used for Textile Slings

Textile Flat webbing slings are manufactured from three man-made fibres: Polyamide (nylon), Polyester and Polypropylene

Although the various fibres have many common features, they react differently to temperature, chemical contact and environment.

## Effects of Temperature

Polypropylene is suitable for use in the temperature range  $-40^{\circ}\text{C}$  to  $80^{\circ}\text{C}$ .

Polyester and polyamide are suitable for use in the range  $-40^{\circ}\text{C}$  to  $100^{\circ}\text{C}$ .

If man-made fibres are used at higher temperatures than those given they will at first soften, begin to melt and fuse together. As the temperature rises they will char, becoming brittle and burn. Natural fibres will simply become brittle, char and burn.

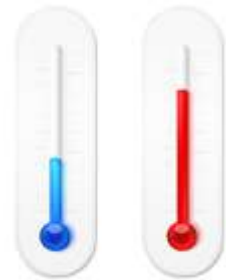

## Chemical Resistance

The various man-made fibres have selective resistance to chemicals as follows:

- Polyamide is immune to the effects of alkalis, but is attacked by acids
- Polyester is resistant to acids but damaged by alkalis
- Polypropylene is little affected by acids or alkalis but is damaged by solvents, tars, paints etc.



## Ultra Violet Radiation

All textile fibres become brittle as the result of exposure to sunlight or other sources of ultra-violet radiation. This is known as solar degradation. Its effect is more pronounced in man-made fibres, but it is hard to detect until at an advanced stage. Then, very quickly, they will become brittle, turn to powder and crumble away.

During the manufacturing stage man-made fibres, intended for use in sling manufacture, are subject to a process known as stabilising. Whilst this does not prevent solar degradation it does slow down the rate of this effect.

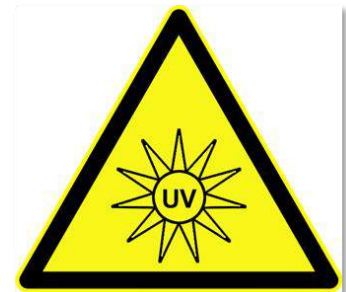

## Effects of Water

Man-made fibres do not suffer in the same way as the natural fibres that were discussed previously, as mildew will not grow on them. If any is found, it is growing on surface contamination which will have no effect on the fibres, and can usually be washed off with clean water. However, water does affect manmade fibres in other ways:



- Polyamide loses about 10% of its strength when wet
- Polyester and Polypropylene is unaffected by water and therefore its strength remains unchanged when wet



## Elongation

Man-made fibres elongate considerably more than natural fibres:

- Polyamide is highly elastic and stretches as much as 40% under load
- Polyester only stretches by approximately 5%
- Polypropylene stretches by varying amounts, usually less than Polyamide but more than Polyester

As well as being elastic, man-made fibres also have plasticity and some permanent elongation occurs every time that they come under load. Whilst this permanent elongation is small, a man-made fibre sling actually becomes slightly longer every time it is used.

## Material Identification

Visually, the various man-made fibres appear much the same. This makes identification extremely difficult. An international system of colour coded labels, which carry the information necessary to be marked on a sling (see marking), has therefore been adopted in standards as follows:

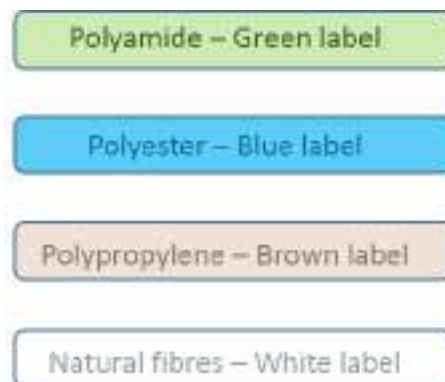

Notes:

## Flat Webbing Sling Construction

The webbing is cut, using a hot knife, so that the cut ends are sealed against fraying. Eyes are then formed at each end and are sewn. Each of the manufacturers has their own stitching patterns and this is relatively unimportant. The standard makes only two important requirements:

- The stitching must be made on a lock stitch machine, so that a cut thread cannot be unpicked or run
- The stitching must not over run a cut end or the selvage of the webbing

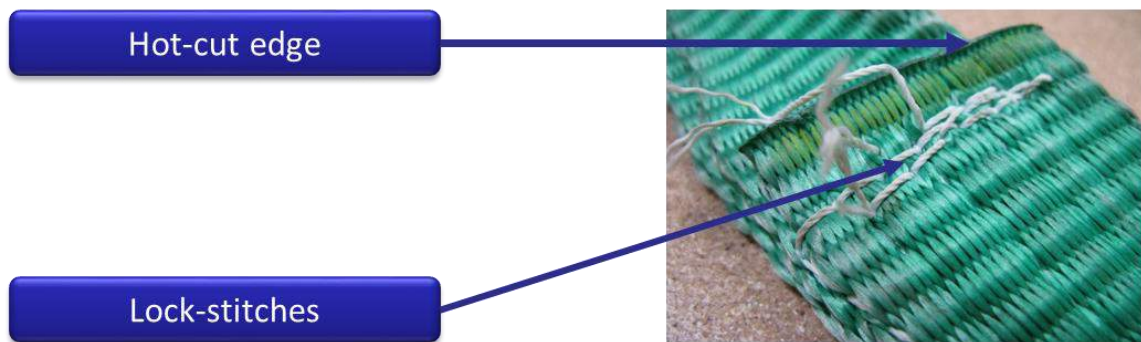

The standard requires that soft eyes are fitted with reinforcement to protect the inner surface from damage. Although some slings will be found in service with sewn in end fittings these are less common now and it will be found that the vast majority of slings have soft eyes.

105

Where metal fittings are made into eyes as part of the sling, it is a requirement of the standard that the fittings must conform to the relevant part of BS EN 1677.



Notes:

## Eye Terminations

BS EN 1492 -1 allows many types of sling eye construction. The following illustrations show the types of eyes accepted by the standard, although others may also be acceptable.

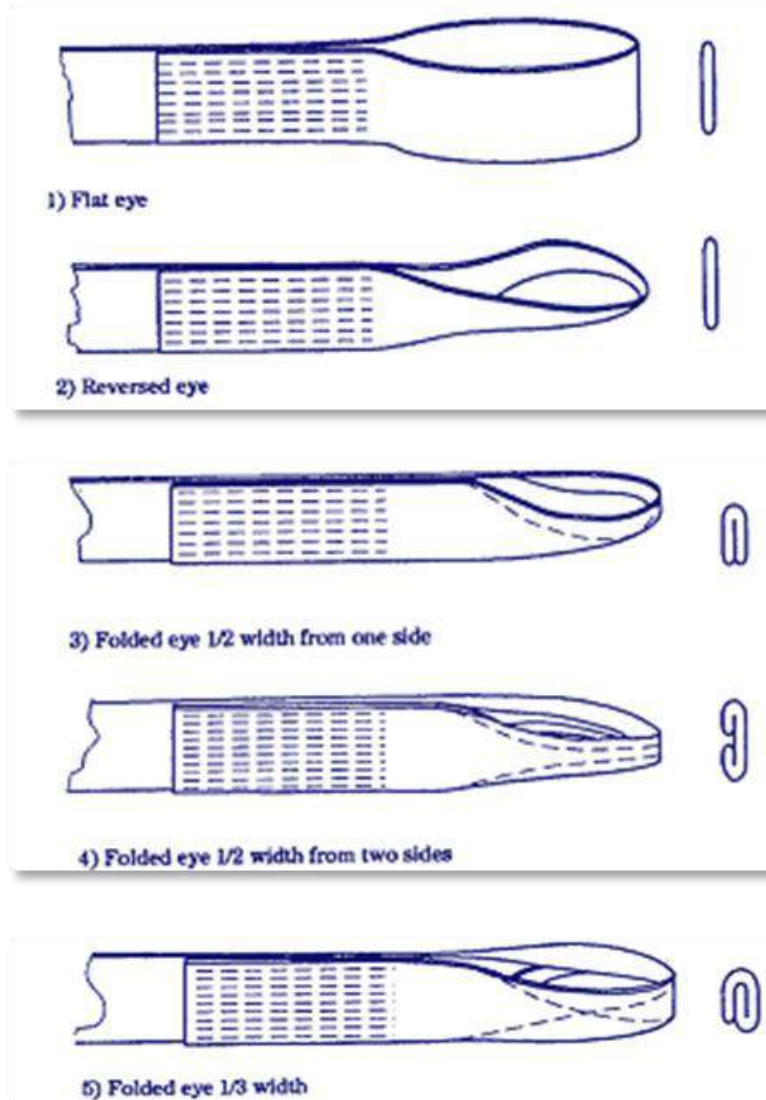

## Manufacturer's Verifications

The first representative webbing sling of each type or construction, including change of material, shall be tested to verify the WLL.

If, during testing, the webbing sling does not sustain a force equivalent to seven times the WLL, but sustains a load of not less than 90% of this force, three further samples of the same type shall be tested. If one or more of these samples does not sustain a force equivalent to seven times the WLL, slings of this type shall be deemed not to comply with BS EN 1492-1

The first representative webbing sling of each type or construction with integral fittings shall be tested to verify the interaction of the webbing sling with those fittings.

Similar tests are made periodically from slings selected from the manufacturing batch to ensure no unexpected changes have taken place. If the specimen fails to sustain less than 90% of this force a further three samples must be selected for test. If any one of these fails the test the batch must be rejected. All slings produced must be visually examined.

### Testing Intervals

With EN ISO 9001/ 9002 Quality system certification

WLL of webbing sling in straight pull	Maximum quantity per type between tests
Up to and including 3t	1000
Over 3t	500

Without EN ISO 9001/ 9002 Quality system certification

WLL of webbing sling in straight pull	Maximum quantity per type between tests
Up to and including 3t	500
Over 3t	250

### Visual and Manual Examination

Each completed webbing sling or sling assembly shall be visually and manually examined including measurement of principal dimensions. If any non-compliance with the safety requirements or if any defect is found, the sling shall be rejected.

### Test and Examination Records

The manufacturer shall retain a record of the results of all tests and examinations for inspection and reference purposes.







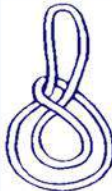

### Marking Requirements

The required marking must be on an appropriately coloured label, signifying the material from which the sling is made. The marking must give at least the following information:

- Traceability code
- WLL
- Material of the sling
- Nominal length
- Grade of any fittings
- Number and part of the standard BS EN 1492-1
- Manufacturer's name
- Marking required by legislation (i.e. the CE mark)

The information shall be marked both legibly and indelibly, on a durable label fixed directly onto the webbing sling. It shall be marked in a type size of not less than 1.5 mm in height. A section of the label shall be stitched under the cover which shall also be marked with this information for reference purposes.

## Working Load Limits and Colour Codes

WLL of webbing sling in straight lift	Colour of webbing sling	Working Load Limit in tonnes								
		Straight lift	Choked lift	Basket Hitch			2 leg sling		3 / 4 leg sling	
										
		M=1.0	M=0.8	Parallel	0°-45°	45°-60°	0°-45°	45°-60°	0°-45°	45°-60°
		1.0	0.8	M=2.0	M=1.4	M=1.0	M=1.4	M=1.0	M=2.1	M=1.5
1.0	Violet	1.0	0.8	2.0	1.4	1.0	1.4	1.0	2.1	1.5
2.0	Green	2.0	1.6	4.0	2.8	2.0	2.8	2.0	4.2	3.0
3.0	Yellow	3.0	2.4	6.0	4.2	3.0	4.2	3.0	6.3	4.5
4.0	Grey	4.0	3.2	8.0	5.6	4.0	5.6	4.0	8.4	6.0
5.0	Red	5.0	4.0	10.0	7.0	5.0	7.0	5.0	10.5	7.5
6.0	Brown	6.0	4.8	12.0	8.4	6.0	8.4	6.0	12.6	9.0
8.0	Blue	8.0	6.4	16.0	11.2	8.0	11.2	8.0	16.8	12.0
10.0	Orange	10.0	8.0	20.0	14.0	10.0	14.0	10.0	21.0	15.0
Over 10.0	Orange									

Notes:

## 15. TEXTILE ROUNDSLINGS

Man made fibre roundslings are a form of endless textile sling which is soft and pliable to use, easy to handle and especially useful of delicate loads. They are however less robust and more liable to damage than equivalent wire rope and chain slings.

The current European standard for the manufacture and verification for textile roundslings is **BS EN 1492-2**.

This standard requires textile roundslings to have a minimum factor of safety of 7:1, in line with the European Machinery Directive.

This standard covers man made fibre textile roundslings made from Polyamide (Nylon), Polyester or Polypropylene.

Where metal fittings are included as part of the sling, it is a requirement of the standard that the fittings must conform to the relevant part of BS EN 1677.

### Fibres Used for Textiles Roundslings

Textile Roundslings are manufactured from three man-made fibres: Polyamide (nylon), Polyester and Polypropylene.

109

Although the various fibres have many common features, they react differently to temperature, chemical contact and environment.

### Effects of Temperature

Polypropylene is suitable for use in the temperature range  $-40^{\circ}\text{C}$  to  $80^{\circ}\text{C}$ .

Polyester and polyamide are suitable for use in the range  $-40^{\circ}\text{C}$  to  $100^{\circ}\text{C}$ .

If man-made fibres are used at higher temperatures than those given they will at first soften, begin to melt and fuse together. As the temperature rises they will char, becoming brittle and burn.

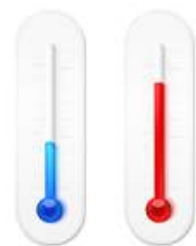

Notes:



## Chemical Resistance

The various man-made fibres have selective resistance to chemicals as follows:

- Polyamide is immune to the effects of alkalis, but is attacked by acids
- Polyester is resistant to acids but damaged by alkalis
- Polypropylene is little affected by acids or alkalis but is damaged by solvents, tars, paints etc.



## Ultra Violet Radiation

All textile fibres become brittle as the result of exposure to sunlight or other sources of ultra-violet radiation. This is known as solar degradation.

During the manufacturing stage man-made fibres, intended for use in roundsling manufacture, are subject to a process known as stabilising. Whilst this does not prevent solar degradation it does slow down the rate of this effect.

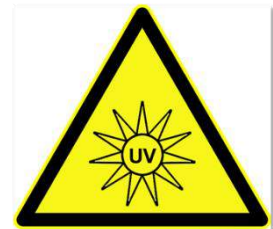

## Effects of Water

Man-made fibres do not suffer in the same way as the natural fibres that were discussed in the previous module, as mildew will not grow on them. If any is found, it is growing on surface contamination which will have no effect on the fibres, and can usually be washed off with clean water. However water does affect manmade fibres in other ways:



- Polyamide loses about 10% of its strength when wet
- Polyester and Polypropylene is unaffected by water and therefore its strength remains unchanged when wet

## Elongation

Man-made fibres elongate considerably more than natural fibres:

- Polyamide is highly elastic and stretches as much as 40% under load
- Polyester only stretches by approximately 5%
- Polypropylene stretches by varying amounts, usually less than Polyamide but more than Polyester

As well as being elastic, man-made fibres also have plasticity and some permanent elongation occurs every time that they come under load. Whilst this permanent elongation is small, a man-made fibre sling actually becomes slightly longer every time it is used.

## Material Identifications

Visually, the various man-made fibres appear much the same. This makes identification extremely difficult. An international system of colour coded labels, which carry the information necessary to be marked on a sling (see marking), has therefore been adopted in standards as follows:

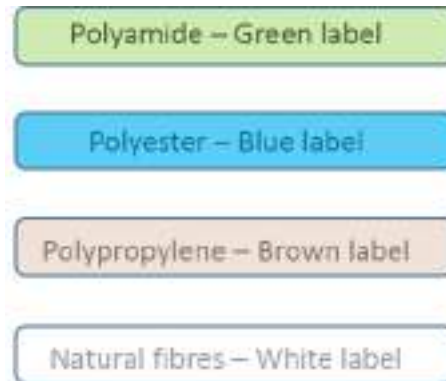

## Roundsling Construction

The core shall be formed from one or more yarns of identical parent material wound together with a minimum of 11 turns, and joined to form an endless hank. It shall be uniformly wound to ensure even distribution of the load. Any additional joins in the yarns shall be separated by at least four turns of the yarn and shall be compensated for by an extra turn per join.

111

This core is the load bearing part of the roundsling.



The cover shall be of webbing woven from identical parent material as the core, and made with the ends overlapped and sewn. The edges of the woven cover material shall be finished in such a way that they cannot unravel.

The thread of all seams shall be made of identical parent material as the cover and core, and the seam shall be made with a locking stitch machine.

The cover is intended for protection and containment of the core so is designed to be non load bearing.



## Manufacturer's Verification

The first representative roundsling of each type or construction, including change of material, shall be tested to verify the WLL.

If, during testing, the roundsling does not sustain a force equivalent to seven times the WLL, but sustains a load of not less than 90% of this force, three further samples of the same type shall be tested. If one or more of these samples does not sustain a force equivalent to seven times the WLL, slings of this type shall be deemed not to comply with BS EN 1492-2.

The first representative roundsling of each type or construction with integral fittings shall be tested to verify the interaction of the roundsling with those fittings.

If, during testing, the cover of the roundsling fails to sustain a force equivalent to two times the WLL of the roundsling, but sustains a load of not less than 90% of this force, three further samples of the same type shall be tested. If the cover of one or more of these samples does not sustain a force equivalent to two times the WLL, slings of this type shall be deemed not to comply with BS EN 1492-2.

### Testing Intervals

With EN ISO 9001/ 9002 Quality system certification

WLL Of Roundsling in straight pull	Maximum quantity per type between tests
Up to and including 3t	1000
Over 3t	500

Without EN ISO 9001/ 9002 Quality system certification

WLL Of Roundsling in straight pull	Maximum quantity per type between tests
Up to and including 3t	500
Over 3t	250

### Visual and Manual Examination

Each completed roundsling or sling assembly shall be visually and manually examined including measurement of principal dimensions. If any non-compliance with the safety requirements or if any defect is found, the sling shall be rejected.

### Test and Examination Records

The manufacturer shall retain a record of the results of all tests and examinations for inspection and reference purposes.

### Marking Requirements

The required marking must be on an appropriately coloured label, signifying the material from which the sling is made. The marking must give at least the following information:









- Traceability code
- WLL
- Material of the sling
- Nominal length
- Grade of any fittings
- Number and part of the standard BS EN 1492-2
- Manufacturer's name
- Marking required by legislation (i.e. the CE mark)









113

The information shall be marked both legibly and indelibly, on a durable label fixed directly onto the roundsling. It shall be marked in a type size of not less than 1.5 mm in height. A section of the label shall be stitched under the cover which shall also be marked with this information for reference purposes.

Notes:

## Working Load Limits and Colour Codes

WLL of roundsling in straight lift	Colour of roundsling cover	Working Load Limit in tonnes								
		Straight lift	Choked lift	Basket Hitch			2 leg sling		3 / 4 leg sling	
										
		M=1.0	M=0.8	Parallel	0°-45°	45°-60°	0°-45°	45°-60°	0°-45°	45°-60°
				M=2.0	M=1.4	M=1.0	M=1.4	M=1.0	M=2.1	M=1.5
1.0	Violet	1.0	0.8	2.0	1.4	1.0	1.4	1.0	2.1	1.5
2.0	Green	2.0	1.6	4.0	2.8	2.0	2.8	2.0	4.2	3.0
3.0	Yellow	3.0	2.4	6.0	4.2	3.0	4.2	3.0	6.3	4.5
4.0	Grey	4.0	3.2	8.0	5.6	4.0	5.6	4.0	8.4	6.0
5.0	Red	5.0	4.0	10.0	7.0	5.0	7.0	5.0	10.5	7.5

WLL of roundsling in straight lift	Colour of roundsling cover	Working Load Limit in tonnes								
		Straight lift	Choked lift	Basket Hitch			2 leg sling		3 / 4 leg sling	
										
		M=1.0	M=0.8	Parallel	0°-45°	45°-60°	0°-45°	45°-60°	0°-45°	45°-60°
				M=2.0	M=1.4	M=1.0	M=1.4	M=1.0	M=2.1	M=1.5
6.0	Brown	6.0	4.8	12.0	8.4	6.0	8.4	6.0	12.6	9.0
8.0	Blue	8.0	6.4	16.0	11.2	8.0	11.2	8.0	16.8	12.0
10.0	Orange	10.0	8.0	20.0	14.0	10.0	14.0	10.0	21.0	15.0
Over 10.0	Orange									

## 16. COMPONENTS FOR SLINGS

Components are covered by the Harmonised European Standard BS EN 1677 series. covering components that are normally supplied as part of a sling (chain, wire rope and textile materials) but occasionally components may be used for other applications, therefore it is important that a components design criteria is checked to ensure that it is fit for the intended use.

These standards control the general design and manufacturing criteria to be applied by the manufacturer, but given the opportunity for manufacturers to adopt their own designs, material specifications and material sizes. As a result, whilst the items produced by individual manufacturers have much in common, they do differ in sizes and sections as permitted within the manufacturing windows of the standard. It is therefore necessary to consult the specific manufacturer's catalogues and technical literature for detailed information.

**The standard has 6 sections:**

Part 1	Forged Steel Components	Grade 8
Part 2	Forged Steel Lifting Hooks with Latch	Grade 8
Part 3	Forged Steel Self-Locking Hooks	Grade 8
Part 4	Links	Grade 8
Part 5	Forged Steel Lifting Hooks with Latch	Grade 4
Part 6	Links	Grade 4

### Manufacturing of Components

In most cases, components are manufactured by forging, mainly drop-forging. This method of manufacture was covered in module 8 of this training course.

In the case of links, some manufacturers produce them by drop forging whilst others hand forge the link by bending a bar to shape and then welding the joint. In yet other cases there is a combination of the processes. The initial bending of a bar is made by hand forging and welding, with the finishing to size achieved by drop forging.

Notes:



# Types of Components



Link



Hook with Latch



Self-Locking Hook



Component Connector



'C' Hook



Webbing Sling Hook



Foundry Hook



Swivel Hook with Latch

## Rings and Links

Rings were once used as the terminal fitting for slings. Their use has declined over the years in favour of master links.

One of the reasons for this is the advance in technology, which has seen the use of alloy steels expand greatly. This advance has resulted in a general reduction in the sizes of hooks etc. with which slings must connect. Even so, a vast amount of older equipment, particularly cranes, remain in service which have a lower grade, and therefore larger, hooks and fittings. The problem with rings is then one of size compatibility, which is largely overcome by the use of links. For example, a 120mm wide link will sit on a deep section hook that a 120mm diameter will not be capable of.

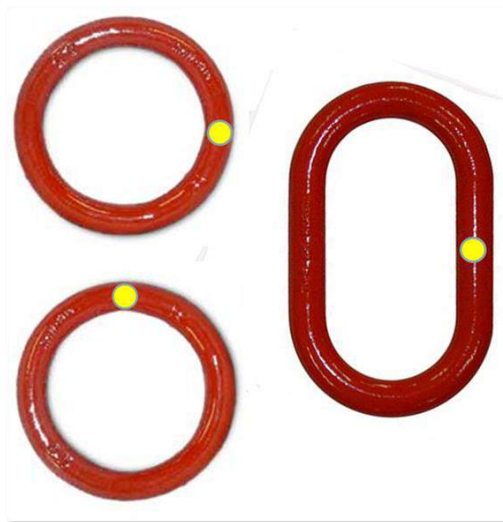
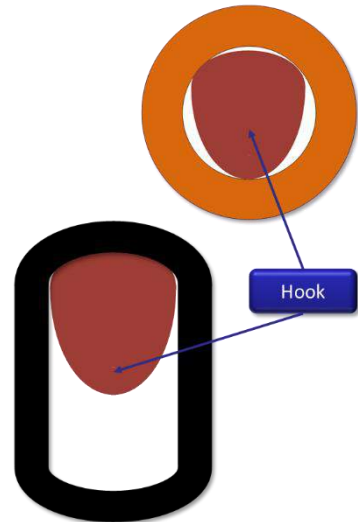

Another advantage of links compared to rings is that the weld will always remain away from the direct line of loading at the least stressed areas of the link.

Common practice for riggers was to turn the link so that the weld was at 90° to the centre line of the load, thereby reducing the stress on the weld, however the ring could turn in service and therefore the weld could reposition itself into the centre line of the load.

Due to the foregoing problem, it is considered that the use of welded rings in new equipment does not meet with the essential safety requirements laid down in the European Machinery Directive (Supply of Machinery (Safety) Regulations in the UK).

117

### Rings in Service

A large amount of older equipment remains in service which is fitted with rings and they may be found on special items. These will usually be grade 40, 4 or (M), but occasionally grade 60 or (S) may be found, particularly in mining, and former mining, areas. However, it should be noted that BS EN 1677 does not specify requirements for rings.



### Stress in Rings

The most severe loading of a ring is due to a load ( $w$ ) being applied diametrically.

A ring with an internal diameter ( $D$ ) greater than 2.55 x the diameter of the material ( $d$ ) from which it was made behaved as if it were a simply supported beam. The maximum tensile stress ( $s$ ) occurs at the extreme layers of the extrados in the line of the load. Most sling master rings are in this condition.

Where the internal diameter ( $D$ ) was less than  $2.55 \times$  the diameter of the material ( $d$ ) from which it was made, it behaved as an encastred beam. The maximum tensile stress ( $s$ ) is at the extreme layers of the intrados at right angles to the line of the load.

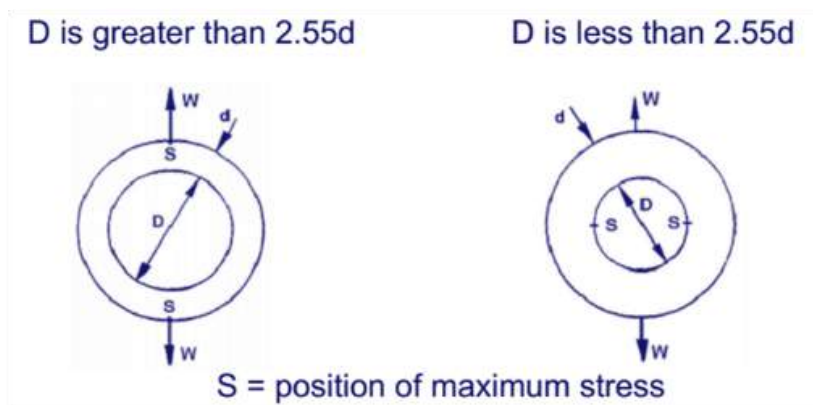

### Stress in Links

In the case of master links intended for chain sling assembly, the link section may be flattened to increase its depth and/or permit narrow jawed coupling components to be fitted to them. Often only a small area on one of the sides of a link is flattened, or further flattened, to allow narrow jawed coupling components to be fitted. The weld in a link should always be positioned centrally in one of the straight sides. This will ensure that the weld never sits on the hook or mates with other components and that it remains in a low stressed part of the link. This requires special attention during the examination, as the flattening mentioned above will often be in the area of, or opposite, the weld.

A link can be considered as a point loaded beam, the sides forming the supports, whilst the curved portion is the beam.

Links behave in a similar way to rings; where  $L$  is greater than  $2.55d$  the maximum stress occurs at the extreme outer layer (extrados) on the crown. Most sling master links are in this condition. Where  $L$  is less than  $2.55d$  the maximum stress occurs in the extreme inner (intrados) at the ends of the straight sides. Intermediate links, joining links and links fitted eyebolts are usually in this condition.

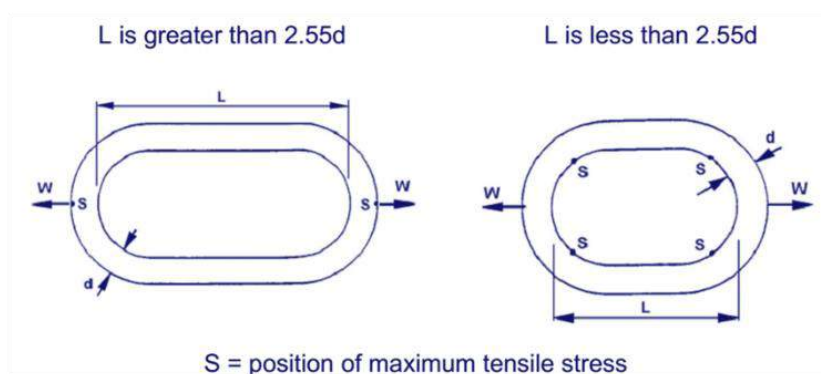

Virtually all grades of links may be found in service. Grades 4, 8 and 10 are commonly available from manufacturers for sling assembly or similar uses.

In the case of grade 8 or grade 10 links conforming to BS EN 1677-4, they will have been proof load tested at the time of manufacture, or verified by other means permitted by the standard. The proof load applied is a minimum of 2.5 x WLL and up to 70% of the radius will usually be supported during this test to prevent the link from collapsing. No alterations, cutting and welding should be carried out to these grades of material and damaged links cannot be repaired.

Grade 40, 4, M, 60 and S links can be cut and welded and repairs can be carried out by any suitably equipped workshop. It is important to note that links require hardening and tempering following welding and subsequently a proof load test at WLL x 2 must be made to prove the integrity of the work.

### Egg Links



Egg links are of an oval shape in profile, resembling that of an egg or pear, with a large diameter at one end and a smaller diameter the other.

They may still be available in grades 8 or 10, with an integral clevis through which the chain is fitted so that they are fitted in the correct position. However, in all other cases, their continued use should be questioned on the grounds of safety.

Similarly to a ring, they can easily turn in service. If they invert so that the smaller end seats on a hook, the hook will be too wide causing the link to deform and/or crack across the weld. It is therefore considered that egg links do not meet with the essential safety requirements of the Machinery Directive (Supply of Machinery (Safety) Regulations in the UK).



Notes:



## Hooks

Over the years, nearly all of the hooks fitted to lifting equipment were of trapezoidal section. The British Standard, BS 2903, covering these was withdrawn some years ago and it is left to manufacturers to adopt their own designs within the parameters of BS EN 1677-2, -3, and -5.

It is now rare to find hooks of trapezoidal section in use with lifting accessories, except in special circumstances or when dealing with older in service equipment. Even so, the general principles of hook design are well established and are followed by the manufacturers. The maximum tensile stress occurs at the extreme layers of the intrados, at right angles to the line of pull, and at the greatest distance from it. The illustration below shows four typical hooks. The long line passing through the hook indicates the line of pull and reaction. The small curved line with arrow heads indicates the position of maximum stress.

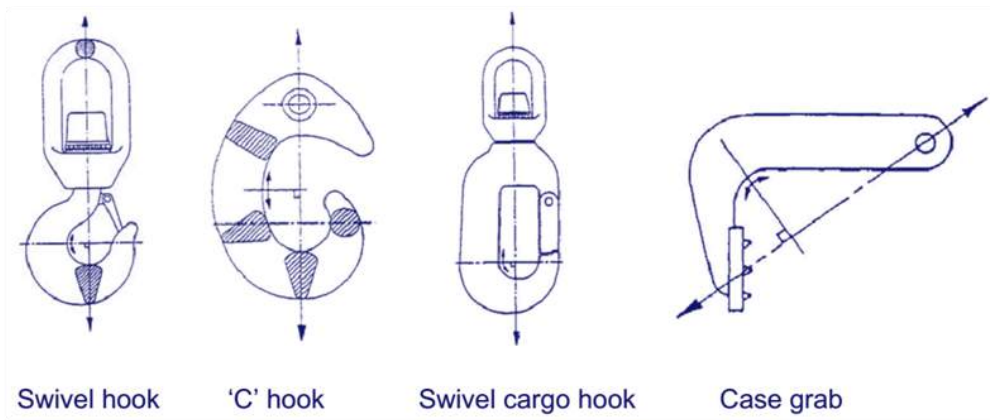

Hooks are designed so that, should they be over loaded, the hook will open slowly and transfer the point of maximum stress onto a slightly larger cross section. In this way the hook actually becomes stronger when it opens, thereby slowing the failure and giving the operative a clear visible warning. You are advised to look at as many examples of hooks as possible, and to study manufacturer's and supplier's literature to familiarise yourself with different hook designs and their uses.



Notes:

## 17. SHACKLES AND EYEBOLTS

### A Brief Introduction

#### Shackles

There are, in the main, two types of shackle used for lifting: the Bow, and Dee types. They are normally forged from various grades of steel, the higher quality alloy steels giving, size for size, a higher safe working load than those made in higher tensile steels, and correspondingly higher tensile steel shackles have a higher safe working load than those made in mild steel. Although the old British Standards BS 3032, BS 3551 and BS 6994 have been withdrawn and/or declared obsolescent for several years, overseas manufacturers and their importing agents still make shackles generally to BS 3032 available. The current Harmonised European Standard for forged steel shackles for general lifting purposes is BS EN 13889:2003, which is a standard for Dee and Bow shackles grade 6.

Shackles to the American US Federal Specification RR-C-271f are extremely popular and, in practice, it will be found that the vast majority of shackles in use today comply with its requirements. This is largely a result of the influence of the oil industry. It is very similar to the Harmonised European Standard and the shackles would meet this standard.

#### Eyebolts

Eyebolts, one of the most widely used items of lifting gear, have severe limitations in usage and a high level of accidents occur as the result of misuse. British Standard eyebolts provide an acceptable level of safety and performance when correctly used and therefore the main part of this section concerns itself in detail with British Standard eyebolts only. When eyebolts to international or other national standards are used, the limitations of usage imposed by those standards should be strictly observed.

121

The current Harmonised European Standard for eyebolts is BS EN ISO 3266:2010. This is also adopted as a British Standard covering collared eyebolts, Grade 4.

Eyebolts that comply with the current British Standard, BS 4278: 1984, will fall within the manufacturing requirements of the standard and consideration within this unit is confined to these. Note that the general matters dealt with here can also be applied to eyebolts complying with other standards. Some background information is also necessary, as many of the eyebolts found in service will be of a commercial pattern and may not be suitable for lifting applications.

#### Shackles

Shackles are probably the most common and universal lifting accessory. Their uses are extensive. They may be used to connect a load directly to a lifting appliance, for the connection of slings to the load and/or lifting appliance, as the suspension for lifting appliances or as the head fitting in certain types of pulley blocks.

The LEEA Code of Practice for the Safe Use of Lifting Equipment, Section 19, deals with shackles and you should refer to this as part of your studies.





## Eyebolts

Although eyebolts are one of the most common lifting accessories they have severe limitations in terms of usage. Often these are not fully understood, and many accidents result from misuse.

This is extensively covered in Section 20 of the LEEA Code of Practice for the Safe Use of Lifting Equipment, which should be read in conjunction with this module.



## Types of Shackle

### Dee Shackle

122

Dee shackles are generally intended for joining two items in a straight line.

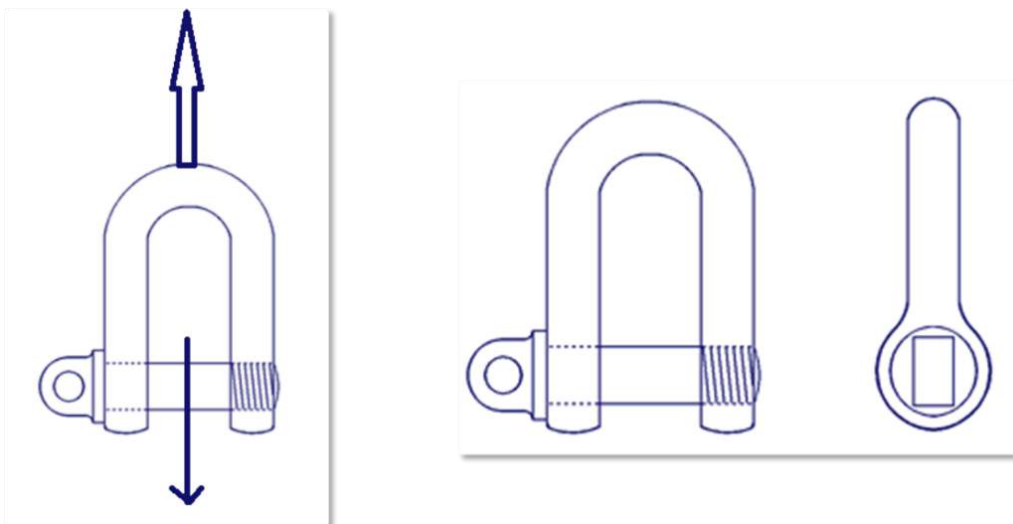

## Bow Shackle

Bow shackles are designed to enable three or more items to be joined. As a result, Bow shackles are usually used when it is necessary to connect a number of slings to hook of a lifting appliance.

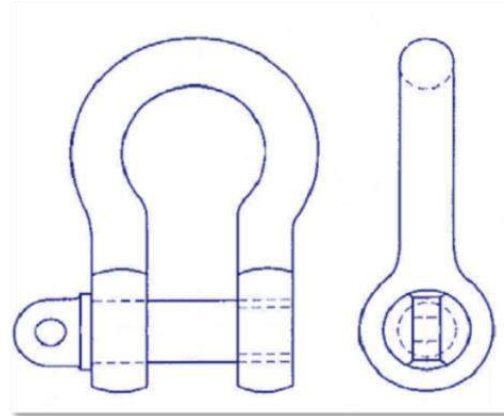
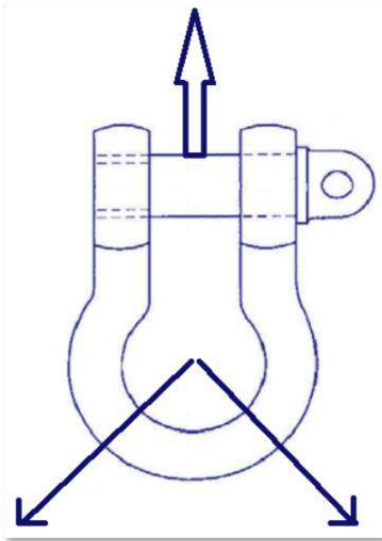

appliance.

## Types of Shackle Pin

123

There are two types of shackle pin in common use, the screw pin, and the bolt, nut and cotter pin.



Screwed pins with eye and collar are the most common type of pin and are suitable for a wide range of uses. However, if they are subject to movement and vibration (eg by a sling moving over the pin), they can loosen and unscrew.

The bolt with hexagon head, hexagon nut and split cotter pin is used where a positive connection is required as it cannot unscrew unintentionally. They are also ideal where a permanent connection is required, (e.g. connecting the top slings to a spreader beam).

Notes:

## Material Used for Shackle Manufacture

### Material Grade

Grade 6  
Identification  
Marking



As we looked at previously, BS EN 13889 standardises grade 6 shackles, although older grade 4 shackles to BS 3032 are still widely available, and shackles to grade 8 are now common in the workplace.

### Shackle Markings

BS EN 13889 requires that each shackle is legibly and indelibly marked by the manufacturer with the following information, in a way that will not damage the mechanical properties of the shackle:

- Working Load Limit in tonnes
- Grade mark
- Manufacturer's name, symbol or code
- Traceability code

Marking should be made, in order to meet the requirement not to impair the mechanical properties of the shackle, this must be in a low stress part (e.g. the straight portion of the standing leg), and not around the crown.

It also requires that pins of less than 13mm diameter are marked with either the grade mark or the traceability code and pins 13mm diameter or above are marked with the grade mark, traceability code and manufacturer's symbol.



## Stress in Shackles

A shackle is carefully designed so that the strength of the body and pin are approximately equal. In order to achieve this, the pin will be of a larger diameter than the body. The pin acts as a beam. If it is subject to a point load, it will be both in a condition of bending and of double shear. If the jaw is fully filled, so that the load is spread evenly over the full width of the pin, it will only be in double shear.

A shackle pin is at its strongest when in a condition of double shear. For a point load, the maximum tensile stress occurs at the centre on the outward facing side of the pin. Standards assume that the pin will be subject to a point load, as this is worst condition, when calculating the pin diameter.

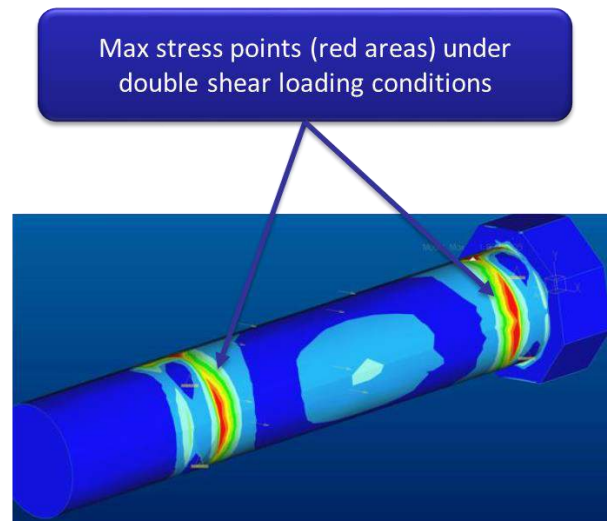

## Types of Eyebolts

### Dynamo Eyebolt

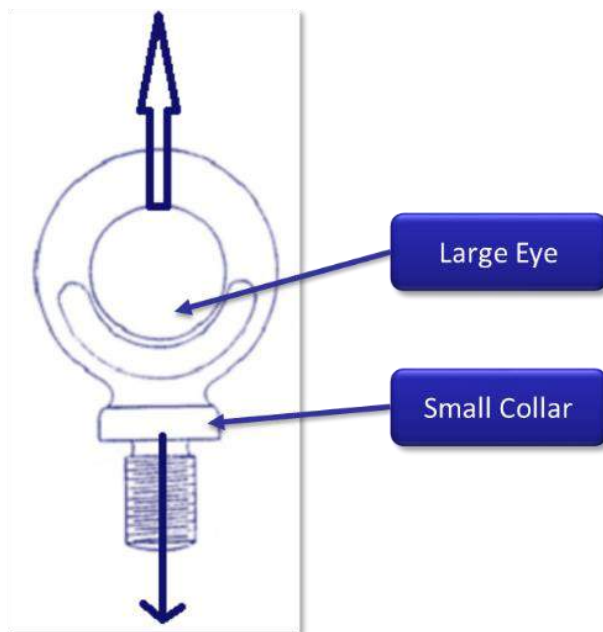

The Dynamo Eyebolt is the most basic in design and the most limited in use, this is because it only suitable for axial (directly vertical) lifting only.

Effectively it is a ring sitting on top of the shank and has only a small collar. Although it is limited to axial loads, the eye is large enough to accept a hook of the same capacity. Dynamo Eyebolts get their name from the historical use to which they are put, being fitted by electric motor manufacturers to the tapped hole over the balanced lifting point of the motor.

## Collared Eyebolt

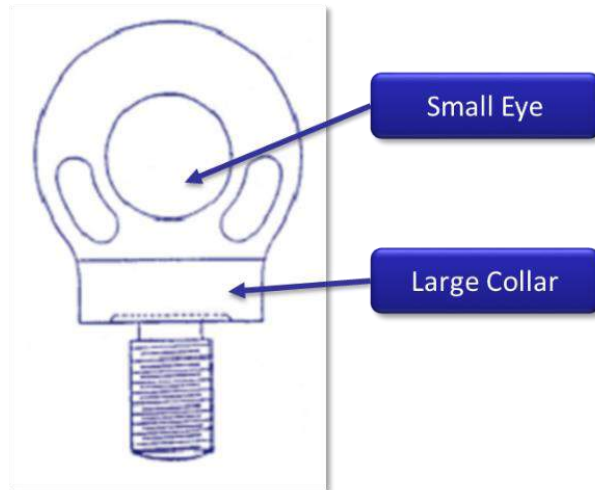

The eye is blended to the collar in one plane. However, the eye is not large enough for direct connection to a hook and it is necessary to use a shackle for connection to other components. When used in pairs of the same capacity, the plane of the eye of each eyebolt must not be inclined to the plane containing the axis of the two eyebolts by more than 5°. In order not to over stress the shank, this alignment may be achieved by use of shims up to a maximum of half of one thread in thickness. A reduction in the maximum load that may be lifted is necessary due to the angular loading. This is far more drastic than is required with the Eyebolt with Link. Although in axial loading, size for size, Collar Eyebolts have a higher SWL, their capacity when subject to angular loads is far lower.

## Eyebolt with Link

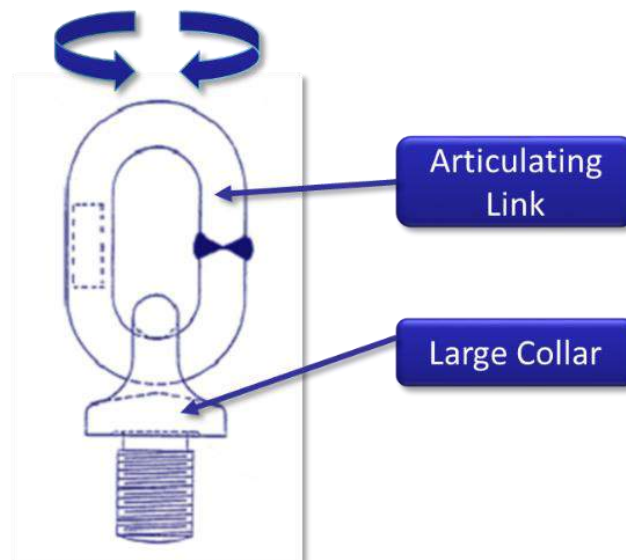

This eyebolt has advantages over the other patterns of eyebolt when the loading needs to be applied at an angle to the axis and/or the plane of the eyes. Provided that the angle of the load to the axis of the screw thread does not exceed 15° they may be loaded in any direction to the full SWL rating.

They have a small, squat, eye which is blended into the collar in all directions and a link is fitted to allow articulation and connection with other lifting components. The link is designed to accept a hook of the same capacity. Compared size for size with Collar Eyebolts, the SWL for axial load is lower. In all other arrangements, the SWLs are relatively greater than those of Collar Eyebolts when used in the same

conditions. Unlike the Collar Eyebolt, the load can be applied away from the plane of the eye, as the link will articulate to align and the collar has equal strength in all directions, making correct fitting easier.

## Material Used for Eyebolt Manufacturer

### Material Grade

Eyebolts are a single piece drop forging, the shank of which is machined and threaded. Those to BS 4278 are made from higher tensile steel, which is hardened and tempered after drop forging but prior to machining. They are therefore grade M or 4.

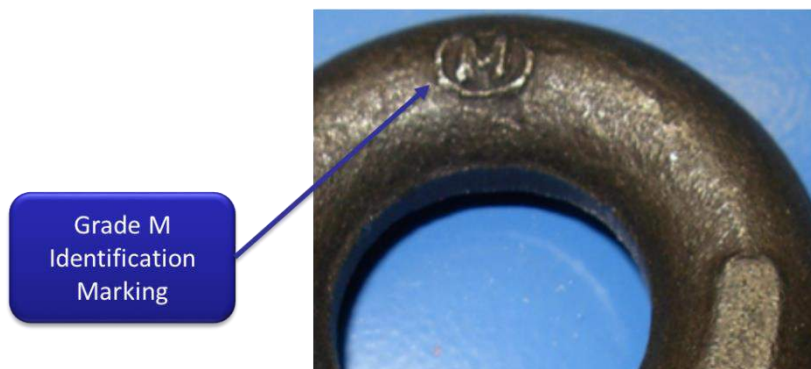

## Undercut

BS4278 and ISO3266 Collared eyebolts and BS4278 collared eyebolts with a link share an important feature: **undercut**.

The illustration below shows the underside of the collar which has a recessed area cut into the collar. This is to allow the collar to seat fully with the load. The undercut facilitates the slight raise of the load surface when a hole has been drilled and tapped into it.





## Thread Run Out

BS4278 and ISO 3266 eyebolts are made with a thread run out. The illustration below indicates the thread form finishing before it reaches the collar of the eyebolt providing a plain length of shank which will prevent stress raisers forming between thread and collar.

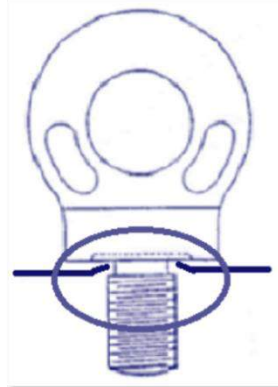

## Eyebolt Markings

The following information should be permanently and legibly marked on each eyebolt:

- Identification mark
- Safe working load
- Quality / Grade
- Screw thread type



The marking shall be either:

- On the side of the link away from the weld in the case of eyebolts with link; or
- On the raised flat areas provided or similar positions in the absence of flat areas in the case of collar and dynamo eyebolts

Additionally in all cases where the designated area is insufficient the periphery of the collar may be used if it can be done without damage to the machined face.

Notes:

## Eyebolt Screw Threads

BS 4278: 1984 states that, “Each eyebolt should be legibly and permanently marked with one of the following thread identifications as appropriate:

- ‘**M**’ to denote **ISO metric** threads, coarse series, including the accepted metric thread diameter designation, e.g. M12
- ‘**BSW**’ to denote **BS Whitworth** threads, including the accepted BSW thread diameter designation, e.g. ½BSW
- ‘**UNC**’ to denote **unified coarse** threads, including the accepted UNC thread diameter designation, e.g. ½UNC”

ISO 3266: 2010 Forges Steel Eyebolts Grade 4 for General Lifting Purposes – this standard of eyebolt only applies to ISO metric threads.

It is therefore recommended that, to avoid the possibility of mismatch, eyebolts of all types and standards and also any tapped holes not so identified should be marked with this information as soon as possible.

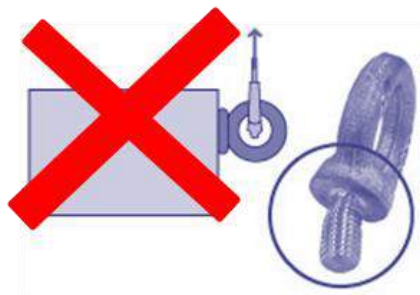
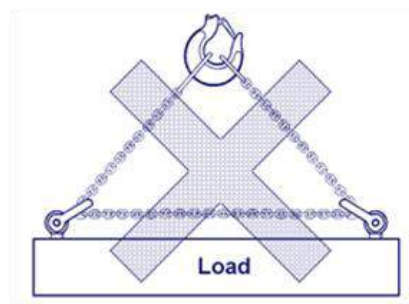
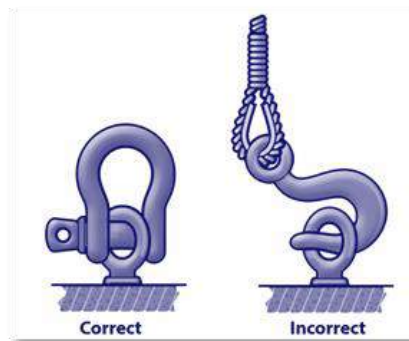

## Stresses in Eyebolts

Incorrect use of eyebolts can result in serious consequences.

It is important that users are appropriately trained in the correct use of eyebolts in order to avoid accidental loading, which may impose stresses that lead to failure.

Operatives should be familiar with the identification of suitable holes and the inspection of the hole. The training should include the method of checking the thread, establishing its fitness for purpose and highlight the dangers of incompatible threads.

Operatives should be shown the correct method of fitting eyebolts and use of shims, and the correct method of attachment to other lifting gear.

Operatives should also have a sound understanding of the ratings of eyebolts for angular loading.

## Eye Nuts and Bow Nuts

There is no British Standard for eye nuts or bow nuts for lifting purposes. Their main use is in pipe hanging and rigging applications and as a result they are usually produced in lower grade material. BS 3974: Part 1: 1974 Pipe hangers etc. gives dimensions and safe working loads for weld-less eye nuts manufactured from mild steel to BS 4360 Grade 43A. They are also produced in other grades to the manufacturers commercial specifications.

130

Eye Nuts and Bow Nuts are not usually intended for lifting purposes, however are useful in certain applications but should only be used for axial lifting.



Notes:

## 18. TURNBUCKLES

### A Brief Introduction

#### Rigging Screws and Turnbuckles

Rigging screws and turnbuckles are used to for the tensioning and fine adjustment of length in lifting assemblies and stays where chain, wire rope or textile element form the main component of the assembly. They can also be used on their own for some applications. Further uses include cargo restraint, suspension, etc.

BS 4429: 1987 covers two distinct types:

- Rigging screws, which have a tubular body, with threads in the range 8mm – 100mm
- Turnbuckles, which have an open drop forged body, with threads in the range 8mm – 72mm

The standard requires rigging screws and turnbuckles used in lifting applications to be proof-load tested and stamped with the working load limit.

US Federation Specification FF-T-791b, Type 1, Form 1 also details a range of turnbuckles in the range ¼" – 2 ¾" (0.25" – 2.75") for such lifting applications.

### The Rigging Screw

131

#### What is a Rigging Screw?

A Rigging Screw has a tubular body, internally threaded at each end, with one right hand and one left-hand thread connecting to terminal fittings of various forms, e.g. screwed eyes, hooks or forks. They are also known in some industries as bottle screws.

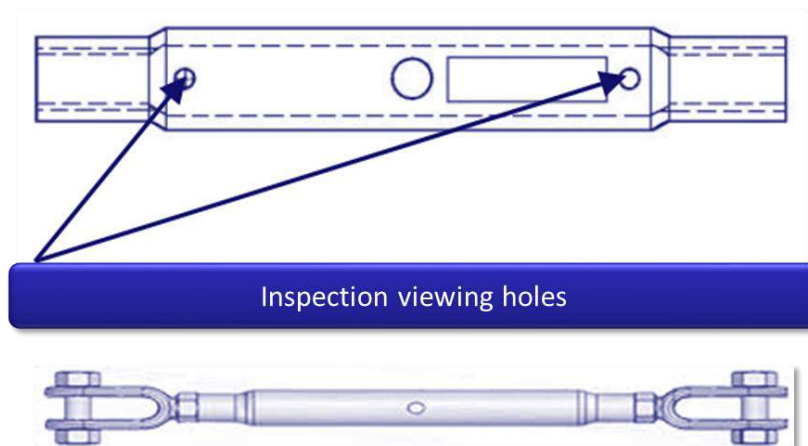

### The Turnbuckle

The principles of the operation of the turnbuckle is to have the screws operating clockwise and counter clockwise to close the eye or opening between two end fittings. It consists of an open body consisting of reins, with internally threaded bosses at each end, with one right and one left-hand thread connecting to terminal fittings of various forms, e.g. screwed eyes, hooks or forks.

©LEEA Academy

Foundation – Step Notes – August 2017 v1.7

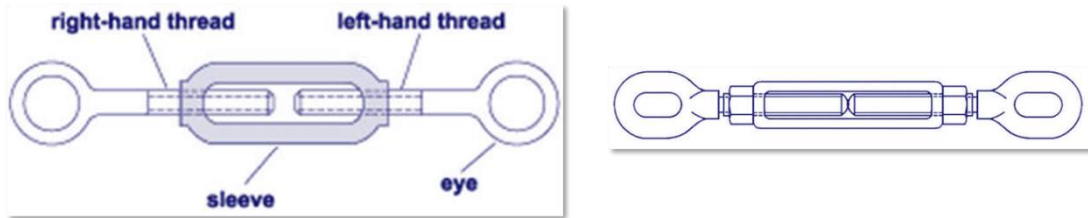
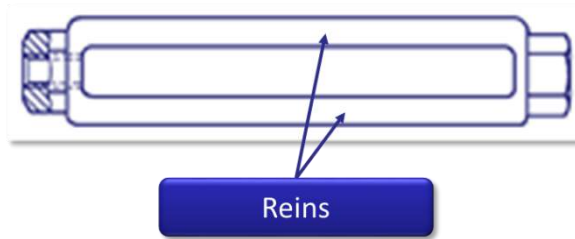

## Types of Rigging Screws and Turnbuckles

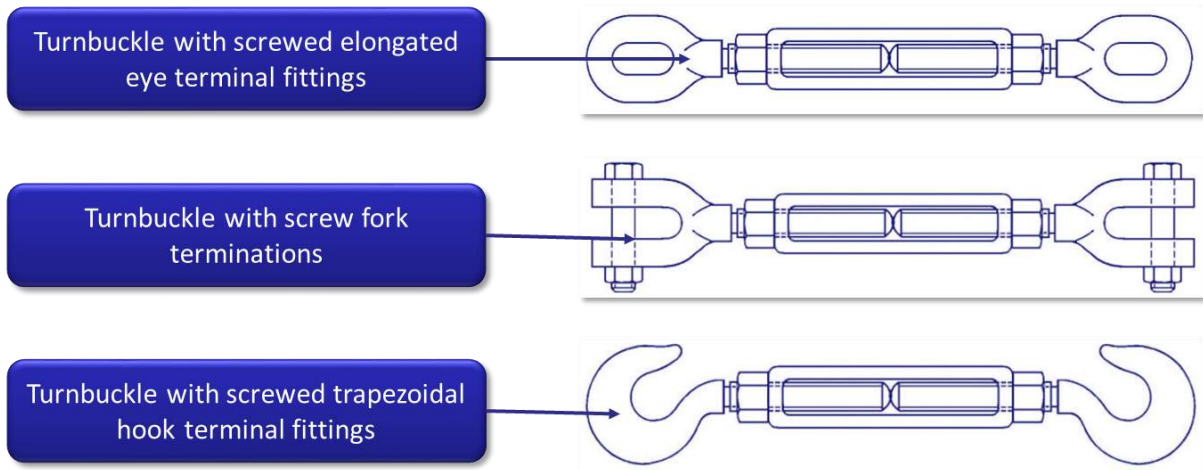

## Marking of Rigging Screws and Turnbuckles

### Marking

Rigging screws and turnbuckles used for lifting purposes should be marked with the following information.

- Working load limit in kilograms or tonnes
- Identification mark traceable to the manufacturer's / supplier's documentation
- Manufacturer's name or identification
- Traceability code on all load bearing components, i.e. body, eyes, hooks, forks, etc.
- CE Marking

Notes:

## 19. MANUAL CHAIN HOISTS

### Manual Chain Hoists

Manual chain hoists are very popular and are found in wide use throughout the world. This is due to the fact that they can be used very effectively in the following applications where:

- A permanent installation for infrequent use is required
- A temporary installation for erection or maintenance purposes is required
- Precise location of the load is required
- A suitable power supply is not available

The current Harmonised Standard for chain hoists is **BS EN 13157:2004, Cranes – Safety – Hand Powered Lifting Equipment.**

Chains shall be in accordance with BS EN 818-7, for fine tolerance short link chains (grade T)

Through the advances in material and manufacturing technologies has enabled much, smaller, lighter and more efficient chain hoists to be produced.



133



Chain hoists utilise a pocketed wheel into which the load chain must fit, but freely enter and leave. The drive to the pocketed wheel is via a hand chain and screw brake mechanism.

The coefficient of utilisation shall be at least 4 for welded load bearing calibrated link chains.

The free end of the load chain shall be fitted with a chain end stop to prevent it from passing through completely.

This end stop shall withstand without rupture 2.5 times the static chain tensile force at rated capacity



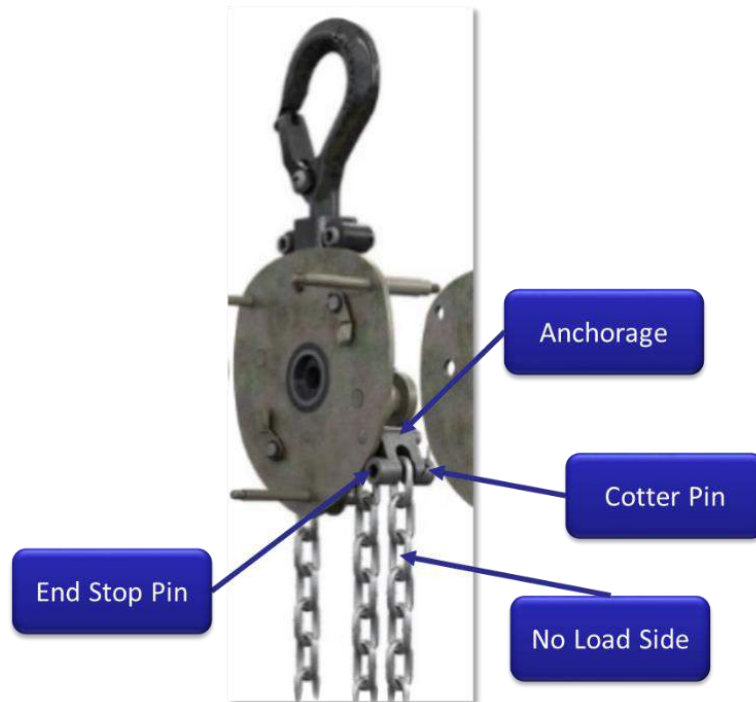

### Components of a Chain Hoist

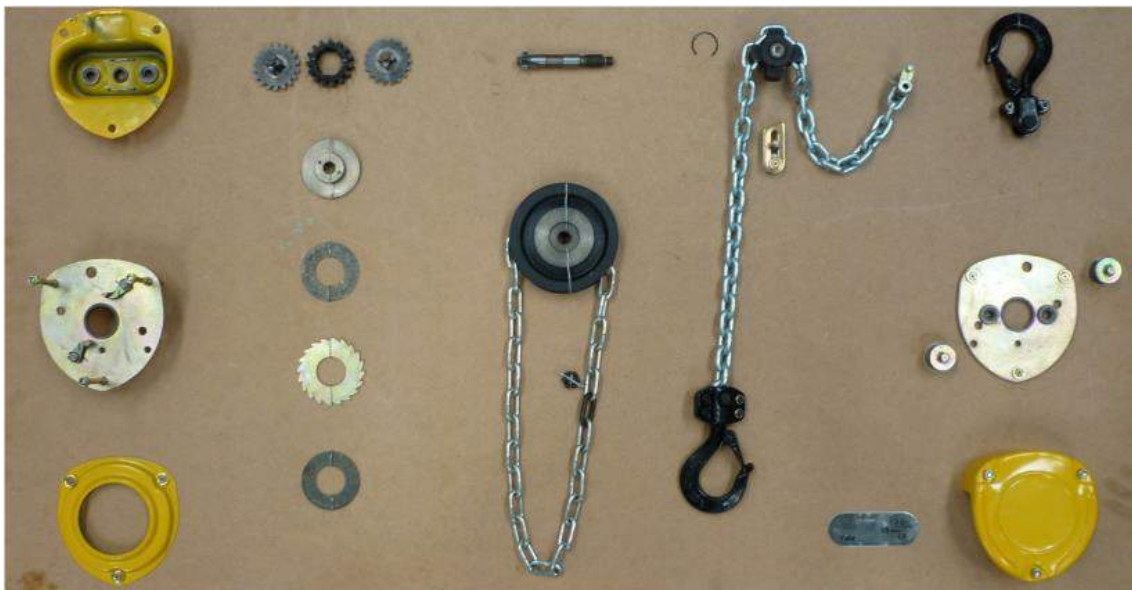

Notes:

## Basic Principles of Operation

As the hand chain is moved in a clockwise direction, this causes the brakes internally to tighten into a single unit which are screwed on to a drive shaft.

The drive shaft has a gear on the end which engages with other gears where the hoist gains its mechanical advantage, meaning we can now lift loads of a greater weight than the effort we are applying.

This drive is then transmitted to the load wheel which raise the load.

When the hand chain is operated in an anti-clockwise direction the hoist brakes now disengage allowing the load to lower, the weight of the load now keeps the brakes engaged when the hand chain is not being operated. This controls the load down in a safe manner.

More detail about the various parts and more in depth explanations will be covered in the LEEA Lifting Machines Manual Advanced Programme.

## The Use of Chain Hoists

### Caution!

135

The instructions from most manufacturers of chain hoists state that they are intended for vertical use only although some also allow for use at an angle.

It is recognised that there are many applications where they are used at an angle to the vertical.

If there is the need to lift at an angle using a chain hoist and this is in contrast to the manufacturers instructions, then the user must carry out a risk assessment and provide adequate instructions for the application.

The load chain should not be used to form a sling around a load and back hooked as this would remove the swivel action of the bottom hook, possibly leading to the chain links becoming twisted and the links at the point of choke which can bend, distort and, at worst, crack the weld.

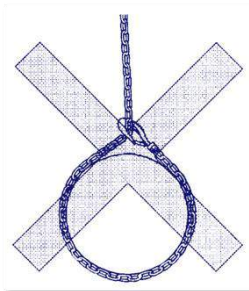

- No part of the load or slings should be in contact with the point of the hook as this could distort and open the hook.
- Do not overcrowd the hook.

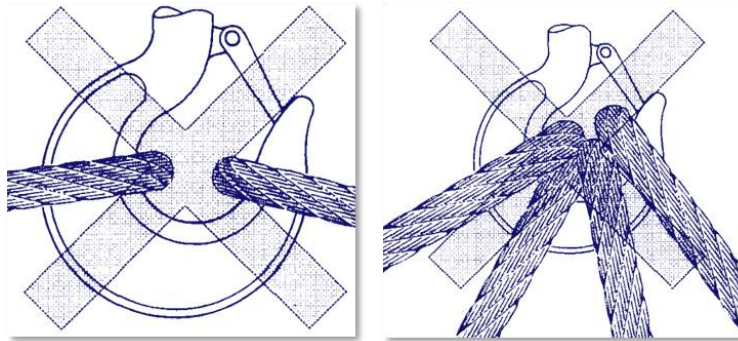

The majority of chain hoists are designed to be operated by a single person – The chain offers sufficient leverage to operate at maximum load, if more than one person is required it is possible that the load exceeds the WLL, the appliance is in need of maintenance or a combination of the two.

Often a split link is incorporated into the hand chain which will part if undue effort is placed on the hand chain, however, this is not a designed safety feature.

Care should be taken to ensure the hoist is not subjected to shock loading.

Care should be taken not to drop the hoist as this can cause:

- Damage to the casing
- Damage to gears or other mechanisms
- Distortion of the hoists alignment



If suspended from a power operated crane hook for accurate load positioning, the SWL of chain hoists should be reduced by 15% to allow for the effects of dynamic loading or shock loading which may occur.

## Marking Requirements

### Marking of Manual Chain Hoists

All manual chain hoists shall have a permanent identification plate located in a clearly visible position, which gives the information listed below in accordance with BSEN 13157.

- The name and address of the manufacturer
- The series or type designation
- The serial number, if it exists
- The rated capacity on the cover and on the bottom block
- Year of manufacture
- The dimensions and quality of the load chains

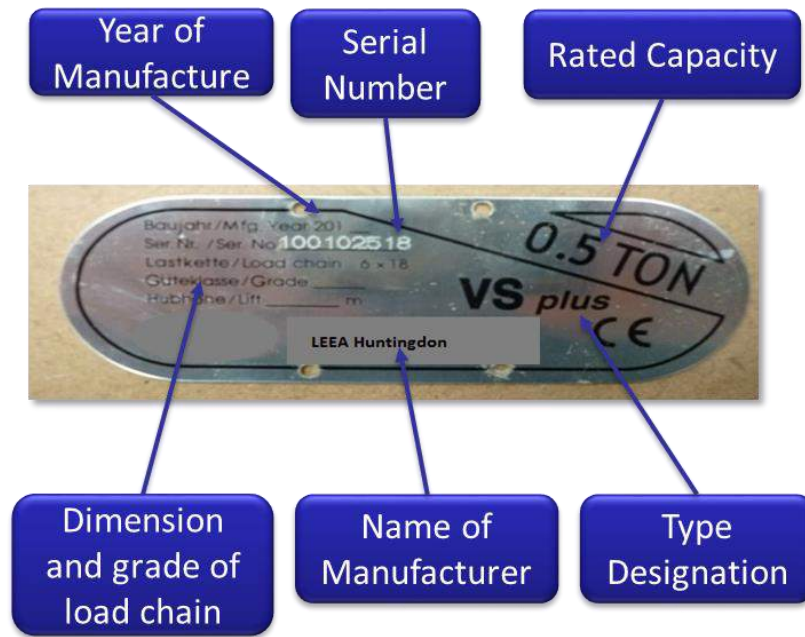

Notes:

## 20. LEVER HOISTS

Hand operated lever hoists are widely used for due to the fact of being able to operate for lifting and pulling applications.

The ability of the lever hoist to be operated in any attitude makes the lever hoist a versatile tool, where it can be used as an adjustable sling leg to enable a load to be balanced or for line adjustment when positioning - to give just two examples.

Two basic types are available: one using fine tolerance (calibrated) steel short link chain, the other using roller chain.



138

The current Harmonised Standard for lever hoists is

**BS EN 13157:2004, Cranes – Safety – Hand Powered Lifting Equipment**

Chains shall be in accordance with:

- EN 818-7, for fine tolerance short link chains (grade T);
- ISO 606, Short pitch transmission precision roller chains and chain wheels.

Through the advances in material and manufacturing technologies has enabled much, smaller, lighter and more efficient lever hoists to be produced.

Lever hoists utilise a pocketed wheel into which the load chain must fit, but freely enter and leave. The drive to the pocketed wheel is via a hand chain and screw brake mechanism.



The lever hoist will also have a change over lever with a neutral position which allows the user to set the chain to the correct length.

The coefficient of utilisation shall be:

- At least 4 for welded load bearing calibrated link chains
- At least 4 for roller chains

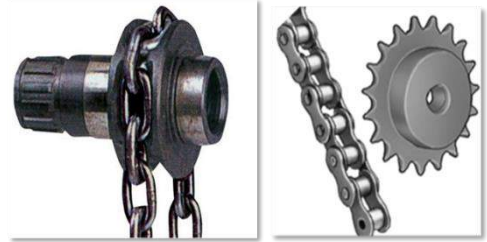

The free end of the load chain shall be fitted with a chain end stop to prevent it from passing through completely.

This end stop shall withstand without rupture 2.5 times the static chain tensile force at rated capacity.

## Components of a Lever Hoist



139

## Basic Principles of Operation

As the lever is operated in the direction marked for raising the load, this causes the brakes internally to tighten into a single unit which is screwed on to a drive shaft.

The drive shaft has a gear on the end which engages with other gears where the hoist gains its mechanical advantage, meaning we can now lift loads of a greater weight than the effort we are applying.

This drive is then transmitted to the load wheel which raise the load.

When the lever is operated to lower the load the hoist brakes now disengage allowing the load to lower, the weight of the load now helps to control the load down by keeping the brakes engaged.

More detail about the various parts and more in depth explanations will be covered in the LEEA Lifting Machines Manual Advanced Programme.



## The Use of Lever Hoists

The load chain should not be used to form a sling around a load and back hooked as this would remove the swivel action of the bottom hook, possibly leading to the chain links becoming twisted and the links at the point of choke which can bend, distort and, at worst, crack the weld.

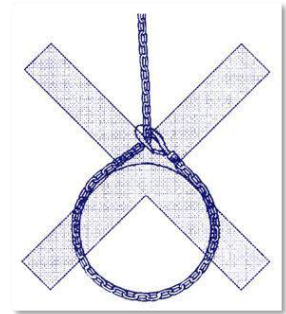

No part of the load or slings should be in contact with the point of the hook as this could distort and open the hook.

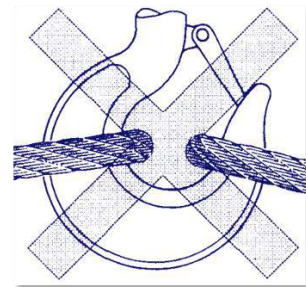

Do not overcrowd the hook.

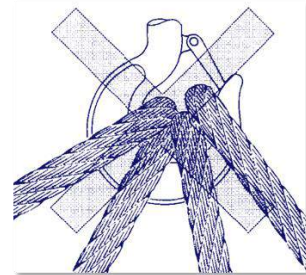

The majority of blocks are designed to be operated by:

- Single person – handle offers sufficient leverage to operate at maximum load
- Should not be shock loaded

Care should be taken not to drop the block as this can use:

- Damage to the casing
- Gears or other mechanisms
- Distortion of the blocks alignment

If suspended from a power operated crane hook for accurate load positioning, the SWL of lever hoists should be reduced by 15% to allow for the effects of dynamic loading or shock loading which may occur.

## Marking Requirements

### Marking of Lever Hoists

All lever hoists shall have a permanent identification plate located in a clearly visible position, which gives the information listed below in accordance with BSEN 13157:

- The name and address of the manufacturer
- The series or type designation
- The serial number, if it exists
- The rated capacity on the cover and on the bottom block
- Year of manufacture
- The dimensions and quality of the load chains
- The marking of the direction of movement

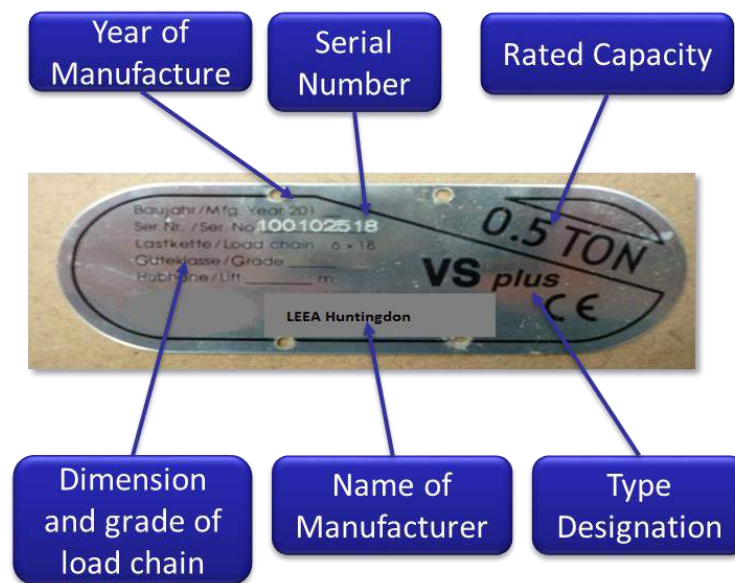

Notes:

## 21. JAW WINCHES

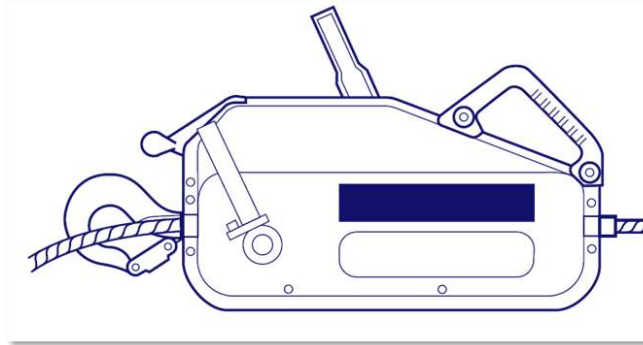

Jaw winches are extremely versatile pieces of lifting equipment.

Due to the rope not being an integrated part of the winch, different lengths of rope can be supplied for each winch.

They are widely utilised as pulling machines as well as lifting which may permit a lower factor of safety giving a higher Working Load Limit when the winch is used in this application.

The current standard covering jaw winches is **BS EN 13157** which requires a minimum factor of safety for lifting in general application of 4:1.

Jaw winches are most common as a manually operated lifting machine, but are available as a hydraulically operated machine.

This would then be linked to a hydraulic pump unit specifically for the jaw winch being used.

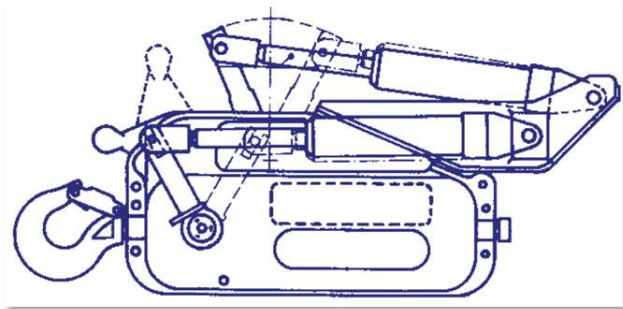

### Major Parts of a Jaw Winch

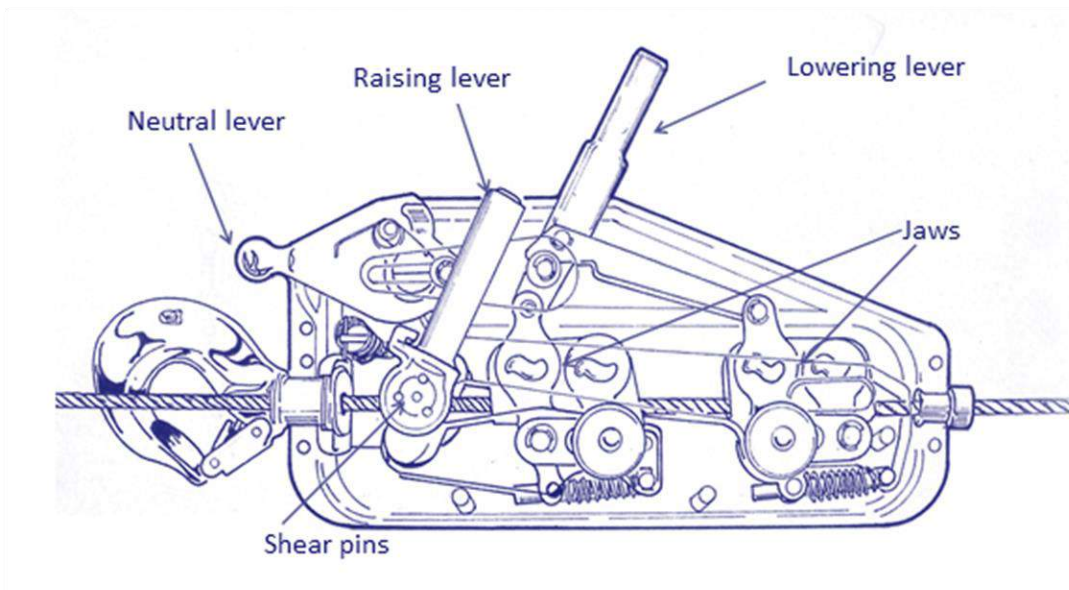

## Principles of Operation

Operates by the 'hand over hand' principle, like a man pulling on a rope.

Two sets of jaws act as the hands. Whilst one set of jaws grips and pulls the wire rope, the other set of jaws change position.

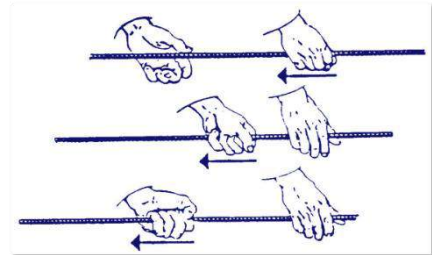

The second set of jaws then grip the rope and the first set of jaws release it, allowing the second set of jaws to pull the rope and so on.

All jaw winches operate by the same general principle.

Effort to the rope in a jaw winch is provided by two levers which act via a lever and cam system on keys.



Each set of jaws is made up of a top and bottom jaw which are brought together (clamped), or separated (unclamped), by means of half-moon shaped keys actuated by levers known as jaw links.

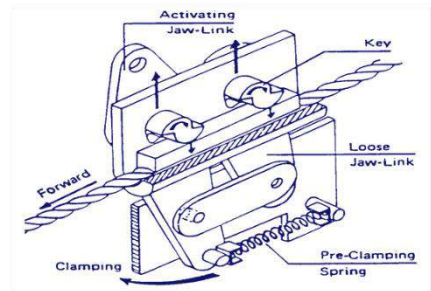

143

## Load Rope

The wire rope supplied for use with a jaw winch should be considered as integral a part of the mechanism as a load chain of a chain hoist.

Some ropes, which appear to be of the correct size and which the winch may accept, may not be suitable. This is due to the efficiency and safety of the friction grip of the winches jaws depend entirely upon the rope being the right diameter and construction being able to withstand the crushing force of the jaws.

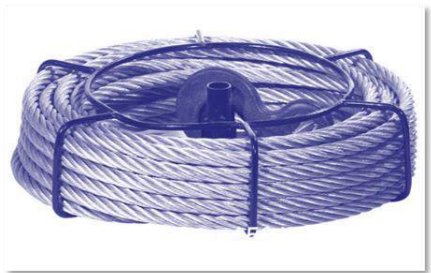

Too small a diameter and the jaws will not grip the rope sufficiently, too large a rope diameter and the rope may become stuck in the winch, rendering the winch inoperable.

It is therefore essential that only ropes approved by the manufacturer are utilised with the specific jaw winch.

One end is plain tapered and fused to allow entry into the machine and the other end is fitted with a terminal fitting for attachment to the load.



## Safe Use of Jaw Winches

The manufacturers specific instructions must always be followed relating to the safe use of jaw winches.

The following points should also be observed:

- The machine must not be used to raise, lower or suspend a load in excess of the Working Load Limit of the machine. When using multiple jaw winches, care must be taken to ensure the share of the load taken by any one winch does not exceed the WLL
- Kinks and broken wires in the load rope can easily jam the winches mechanism rendering the winch inoperative
- Only use the handle from the manufacturer, with no extensions fitted. One person with the correct handle should be able to operate the winch up to its WLL
- Do not attempt to operate both raise and lower lever at the same time
- The raising lever is fitted with shear pins specific to the machine as a safety device, these must not be replaced with anything differing from the manufacturers approved replacement parts

## Marking Requirements

All jaw winches shall have a permanent identification plate located in a clearly visible position, which gives the information listed below:

- The name and address of the manufacturer
- The series or type designation
- The serial number, if it exists
- The rated capacity
- Year of manufacture
- The dimensions and quality of the ropes
- The marking of the direction of movement

In addition, the ropes due to being detachable should also be marked permanently and legibly with the information listed below:

- Identification mark
- Safe Working Load
- The length of the rope

Notes:



## 22. JACKS

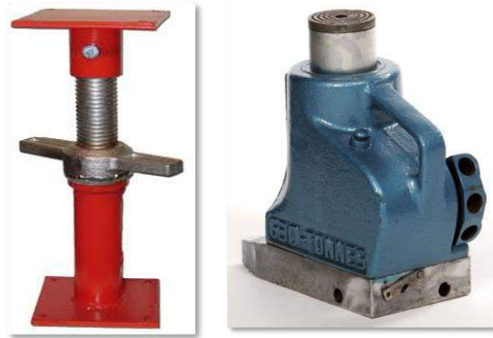

Jacks are widely used for lifting purposes where loads need to be raised or lowered a limited distance. This module will concentrate on mechanically and hydraulically operated jacks where the load is supported on the head or toe of the jack.

The current standard is

**BS EN 1494 – Mobile or movable jacks and associated lifting equipment**

This standard requires a minimum factor of safety of **4:1**.

### Mechanical Jacks

145

#### Ratchet Jack

The ratchet jack operates by pawls engaging with a rack.

As the holding pawl holds the load in position, the lifting pawl moves downwards to engage with the rack.

This then engages with the rack and levers upwards whilst the holding pawl is held away from the rack.



#### Screw Jack

The jack base is manufactured with a female screwed thread. Into this is fitted a male screwed shank.

Directly turning the screwed shank causes the load to raise or lower.





## Journal Jack

Operation of a journal jack is done by operating a ratchet lever which turns internal gears and driving the shank inside the jack to raise and lower the load.



## Hydraulic Jacks

Aluminium Jack



Tubular Steel Jack



## Principles of Operation

Hydraulic jacks use oil with the body of the jack acting as the reservoir for the oil.

When the jack is operated, the oil is passed through a system of non return valves to the underneath of the lifting ram.

When more oil is delivered through each stroke of the handle, the lifting ram is forced out of the chamber lifting the load.

Lowering of the load is achieved by opening a valve which allows the oil to return to the reservoir by the load pushing down on to the lifting ram.

## Schematic drawing of a hydraulic jack

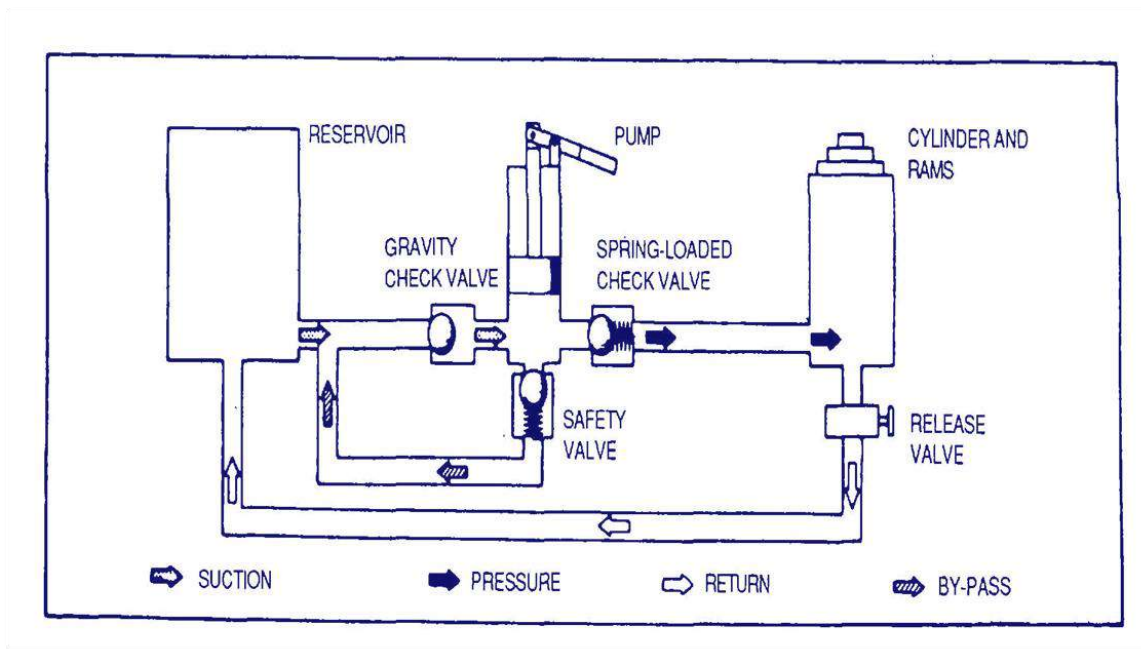

## Safe Use of Jacks

147

- In addition to any specific instructions relating to the safe use of the jack issued by the manufacturer, the following points should be observed:
- Most jacking operations require the use of multiple jacks. The capacity of the jacks should be adequate to account for this and the operation must be supervised in such a way that this condition is limited
- An agreed system of instruction and signals should be used so as to avoid any confusion between the operatives
- The floor must be capable of withstanding the load that will be imposed on it by the jacks
- The surface on which the jack is to be placed should be level and even
- The jacking point on the load must be carefully selected so as to ensure the jacking operation does not damage the load
- Never raise a load higher than is necessary
- Never leave a load supported entirely by jacks
- Only use packing which is capable of withstanding the crushing effect of the load
- Care must be taken to prevent the jack kicking out or toppling due to sideways loading or destabilisation

- In cases where independent cylinders and pumps are employed, additional measures may be necessary to ensure stability
- Care must be taken to ensure operatives do not become trapped or pinned by the movement of the load in confined spaces
- Never reach, or allow anyone else to reach, under a load supported by jacks
- Under no circumstances should anyone be permitted to work or climb on a load which is supported by jacks
- Never over-extend a jack
- In the case of ratchet jacks on no account should any attempt be made to balance and hold the load by applying effort to the operating lever between ratchet stops

## Markings

Every jack shall be marked permanently and legibly on a non removable part of the device with the following information:

- The business name and full address of the manufacturer and, where applicable, his authorised representative
- Design of series or type
- Product code and designation of the machinery
- Serial number or batch code
- the year of construction, that is the year in which the manufacturing process is completed
- Rated load

Notes:

## 23. CRANE FORKS AND C HOOKS

Harmonised Standard **BS EN 13155:2003, Cranes – Safety – Non – fixed load lifting attachments.**

- Clause 5.2.4 gives the specific requirements C-hooks must meet
- Clause 5.2.5 details lifting forks
- Fabricated lifting accessories, suspended from crane hooks
- Lift loads directly without other lifting accessories being necessary
- C-hooks are usually designed to lift a specific load
- Crane forks are of a more general nature and are usually supplied as a standard product

This unit brings together two other fabricated lifting accessories, crane forks and C-hooks, which are suspended from crane hooks but lift loads directly without the need for other lifting accessories.

Whilst C-hooks are usually designed to lift a specific load, crane forks are of a more general nature and are usually supplied as a standard product. Although very different in design crane forks and C-hooks have much in common, which enables them to be considered together. Differences will be noted as and where relevant.

149



### Crane Forks

Crane forks are used to lift palletised or similar loads suspended from a crane hook.



## C-Hooks

C-hooks are used to lift hollow loads such as pipes, paper rolls or coils of steel. Fabricated from profiled plate or rolled beam sections.



## Marking Requirements BS EN 13155

- CE mark
- Identification mark
- Working load limit
- Minimum working load if appropriate
- Name of manufacturer
- Year of manufacture
- Self weight of crane fork if it exceeds 5% of WLL or 50 kg



Notes:

## 24. POWERED LIFTING MACHINES

Powered lifting machines are widely used in industry, often as part of a larger lifting installation, e.g. with an overhead runway, jib crane or overhead travelling crane, or where a permanent lifting facility is required. They may also be used for fixed position lifting applications or where a temporary powered lifting facility is required.

Powered lifting machines are available with electric or pneumatic operation, but the most common in general use at the present time will be found to be electrically operated.



Powered lifting machines are ideal for heavier or repetitive lifting applications as they offer the following advantages over manually operated chain hoists:

- Speed of operation
- Less fatigue for operatives, particularly on long lifts
- Operatives may be remote/away from the load

151

**BS EN 14492-2: 2006 + A1: 2009 - Cranes - Power driven winches and hoists - Part 2** is the specification for power driven hoists. Prior to its publication in 2006 there was no British Standard dealing specifically with power operated hoists but there were standards for cranes and some of the component parts such as wire rope and chain.

Reference may also be made to FEM 1001 - Rules for Design of Hoisting Appliances.

Notes:



## Types of Powered Lifting Machines

Floor Mounted Electric Winch



Trolley Mounted Electric Wire Rope Hoist



Electric Chain Hoist

Pneumatic Chain Hoist



Hydraulic Winch

Hydraulic Chain Hoist

## Electric Chain and Wire Rope Hoists

Modern electric power operated hoists are normally fitted with low voltage control which is derived internally within the unit by transformer. This is usually in the range of 24 to 50 volts AC or DC and is often known as 'Extra Low Voltage'. Older hoists and special purpose hoists may not have LV control. It should also be noted that it is common in many European countries to use mains voltage control. The two principal lifting media used with all power operated hoists are:

- Short link round steel chain
- Steel wire rope

In hoists which utilize chain, the chain passes over a pocketed wheel, the slack side of chain hanging loose. A collecting box may be used to house the slack chain, but as this sits below the body of the hoist it restricts the height that certain loads may be lifted.

In hoists which utilize wire rope, the wire rope passes on and off a drum upon which it is stored. The range of lift is limited by the amount of wire rope that the drum can accommodate.

### Pneumatic Hoists

Pneumatic power operated hoists tend to be more limited in use than electric power operated hoists, mainly due to the problems associated with the provision of a suitable air supply. However, they offer many advantages over electrically operated equipment and as a result are widely used in industries where air is provided for other purposes or where the safety aspects associated with air operated equipment are a major consideration.

### Hydraulic Hoists

The hydraulic hoist provides smooth and accurate lifting and lowering operations and is very quiet in operation. An electric motor is used to run a hydraulic motor. The hydraulic motor is a mechanical actuator that converts hydraulic pressure and flow into torque, or rotation, which in turn moves the hoist. The advantages of this form of machine are that the electric motor does not have to be physically near the fluid drive, so the system is virtually noiseless. They are regularly used in intrinsically safe areas, as is the pneumatic hoist.

Notes:

## Hoist Components



Load chain pocket wheel typically found in the electric chain hoist



Wire rope drum used to accommodate the load rope on a typical electric wire rope hoist

## Electrical Controls

Other control options, such as radio or infra-red controls, enable remote or central control. They are useful in areas where direct access may not be possible. Multi-point controls, usually wall mounted, enable hoists to be controlled from several positions, which is useful in applications such as raising loads through several floor levels. Such arrangements must be suitably inter-locked to prevent more than one control operating at a time. A further essential requirement with this arrangement is the provision of emergency stop buttons to override all control positions until manually reset.

## Hydraulic and Pneumatic Controls

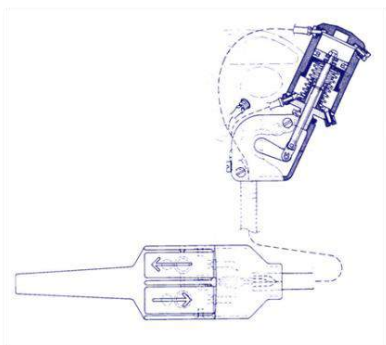

Pneumatic Controller



Hydraulic Controller

## Safety Devices



In accordance with BS EN 14492 - 2 various safety devices are used in lifting appliances to limit the amount of movement, to protect the appliance from the worst effects of overloading or otherwise protect the appliance.

These may be essential to the safe use and therefore be fitted as standard or provide additional features to the safe use of the appliance and be available as optional extras.

It is therefore necessary to consult the manufacturer's specification to establish what provisions are made as standard and discuss any additional or special requirements with the supplier.

155

### Emergency Stop

Powered hoists shall be provided with an emergency stop function which is to be available and operational at all times.

Electrically, pneumatically and hydraulically powered are required to have the emergency stop facility in accordance with BS EN 14492-2 s5.2.3.



Notes:



### Motion Limits

For modern hoist units it is a mandatory requirement of BS EN 14492-2 to have upper and lower limits fitted that conform to the minimum requirements of BS EN 12077-2.

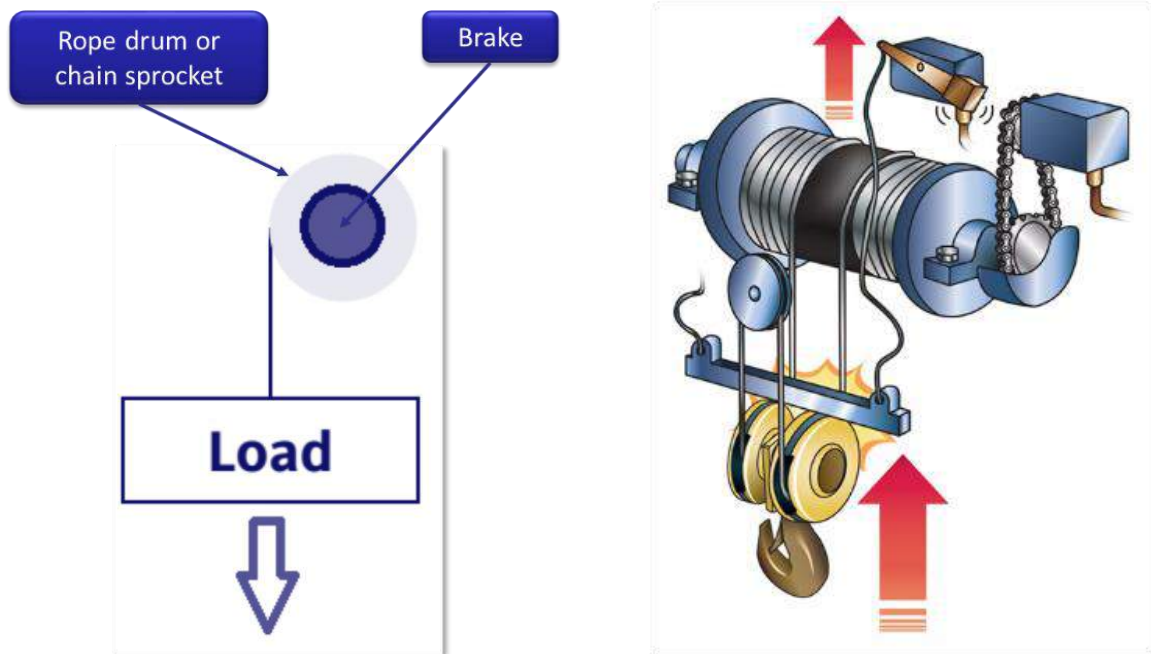

### Overload Protection

For modern hoist units with a rated capacity of 1t or more, it is a mandatory requirement of BS EN 14492-2 to have a Rated Capacity Limiter.



### Hoist Brakes

For modern hoist units designed and built to BS EN 14492-2, hoist brakes must be fitted which engage automatically in the event of any of the following situations:

- When the control device returns to its neutral position
- When the emergency stop function is activated
- If the external power supply to the brake is interrupted
- If the power supply of the hoist/lower motor is interrupted or switched off

## 25. RUNWAYS AND CRANE STRUCTURES

### Runways

Runways are widely used in industry to provide a track upon which is fitted a lifting appliance to allow loads to be raised, lowered and travelled along the path of the runway.

Runways can be manufactured from standard rolled steel sections or from special track sections and may be supported from building structures, dedicated free standing structures or a combination of both.

Runways offer a cost effective alternative to overhead travelling cranes. Their design can range from a simple beam to more complex systems which may include switches, turntables and bends allowing the movement of the load along alternative routes.

### Built in Runways

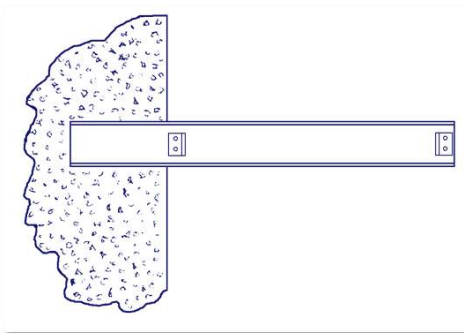

Built-in Cantilever Runway

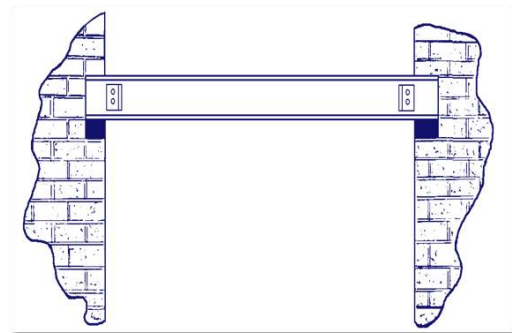

Encastre (Built-in each end) Runway

### Suspended Runways

Runways can also be suspended from suitable roof members or beams built into the building structure.

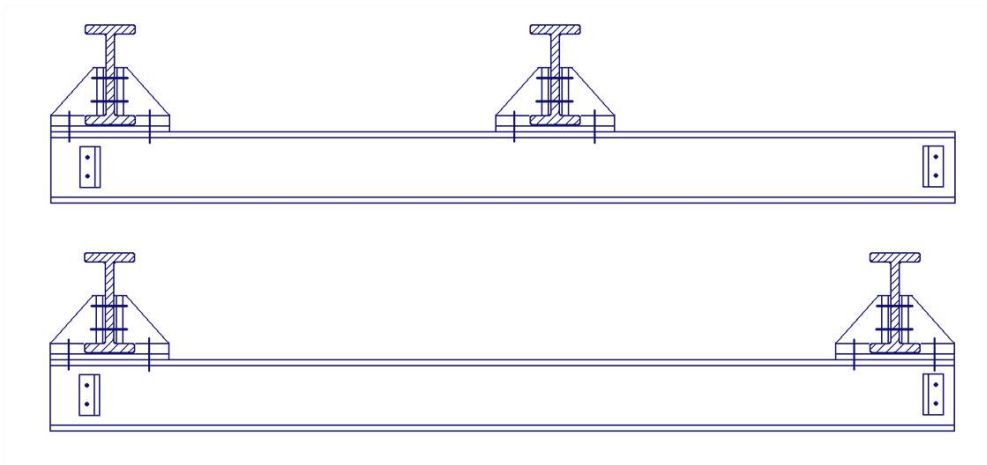



## Free Standing Runways

If no suitable supports are available then free standing runway structures are common.

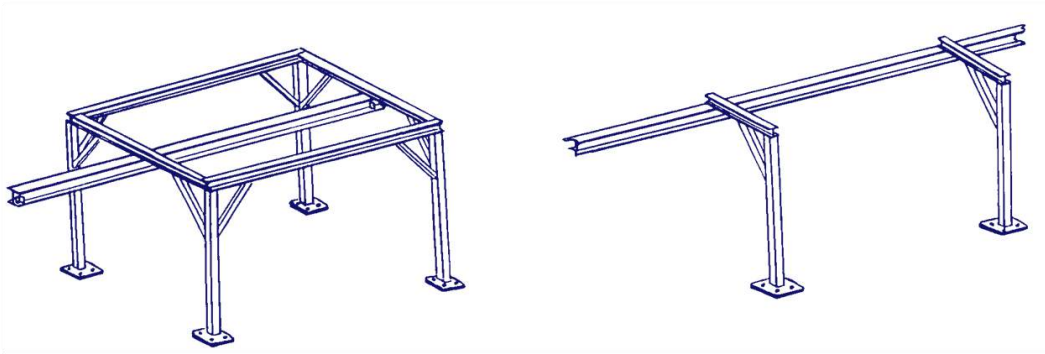

## Special Track Section

Runways and light duty crane systems may also be manufactured from special track section.

There are many different manufacturers of these systems.

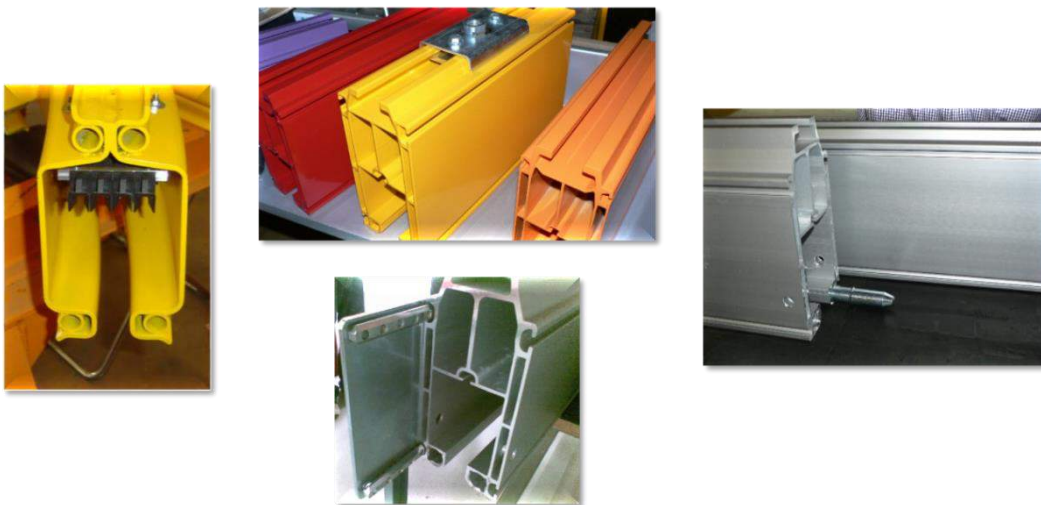

These runways are then suspended on either suitable building members or free standing structures.



## Runway Switches and Turntables

The use of runway switches and turntables allow the lifting appliance to be transferred from one runway system to another.

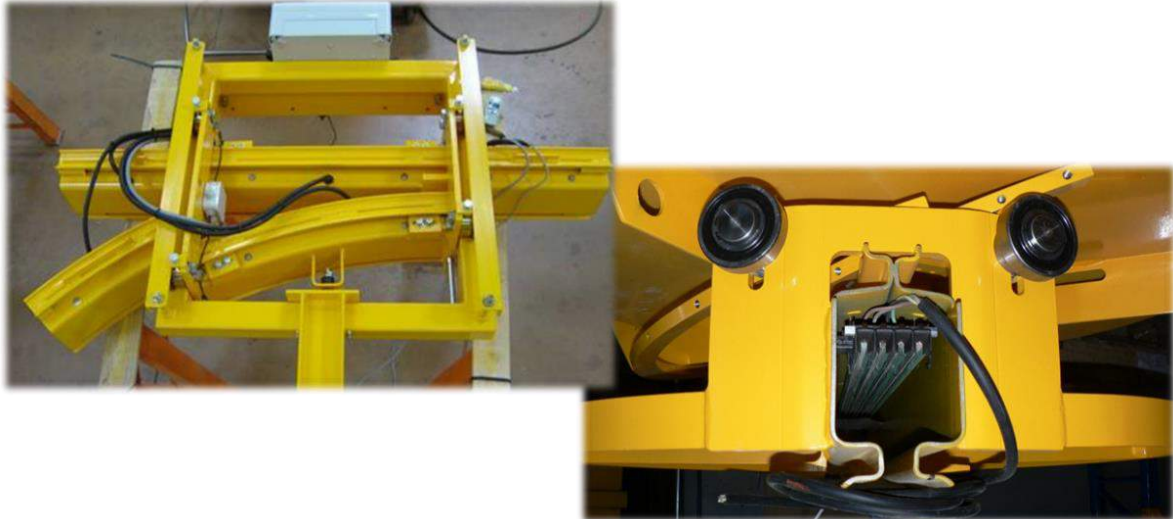

## Mobile Gantries

159

Very often, a mobile gantry is used in areas where it is not cost effective to have a permanent installation.

**Note:** The majority of mobile gantries are not intended to be mobile whilst under load. The only intended movement in these cases is along the runway itself. Ensure that all manufacturer's instructions are followed when using a mobile gantry.





Internally Braced Gantry



Externally Braced Gantry

### Slewing Jib Cranes

Slewing jib cranes are widely used in conjunction with manual or powered lifting machines where a permanent facility is required to perform lifting and limited moving operations.

They offer a wide area of floor coverage within the slewing radius (this can be a limited radius or 360°) of the arm and are ideal where full overhead travelling crane coverage is not required.



Wall/ column underbraced slewing jib crane – note the position of the stops

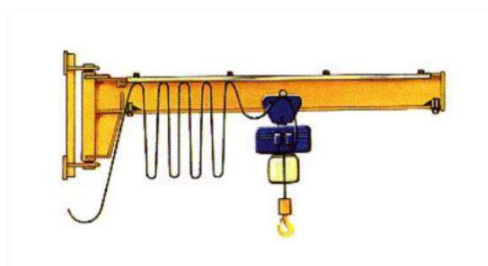

**Wall/ column overbraced slewing jib crane** – note how the position of the stops now give more distance of effective travel

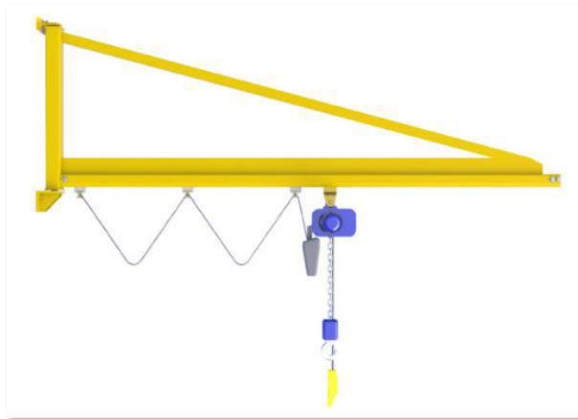

Notes:

## 26. OVERHEAD TRAVELLING CRANES

Overhead Travelling Cranes can be manufactured in many forms. The most common types of overhead crane are as illustrated below:



Lattice Girder



Box Girder



Rolled Steel Girder

Overhead travelling cranes can be either top running or underslung from their support structure:

Top Running

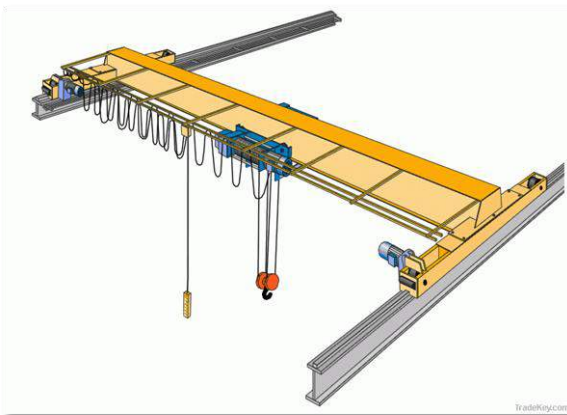

Underslung

### Portal Cranes

A Portal crane may be of single or double girder configuration, running on tracks at floor level. The main advantage of the crane running on ground tracks is that an overhead steel gantry is not required. Portal cranes are ideal for outdoor applications where lifting facilities are provided without the cost of a building or supporting steelwork. They are also suitable for indoor applications where existing building structures are not capable of taking overhead travelling cranes and where additional supporting steelwork would result in a loss of floor area.





Portal



Semi-Portal

### Typical Components of an Overhead Travelling Crane

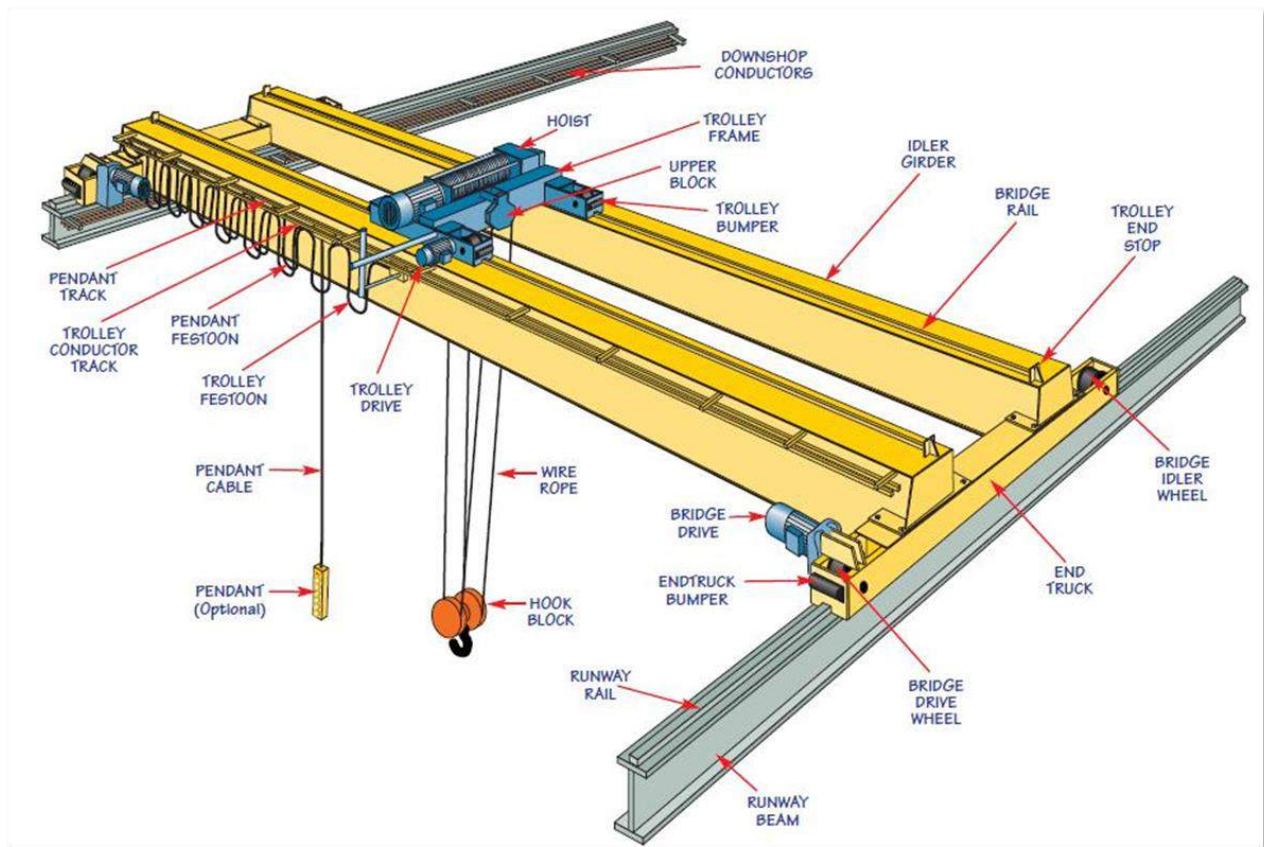



## Types of Overhead Crane Controls



Cab



Wired Pendant



Remote

Notes:

## 27. OFFSHORE CONTAINERS

### What is an Offshore Container?

An offshore container is described as a freight or service container with a maximum gross mass not exceeding 25000kg, intended for repeated use to, from and in between offshore installations and ships.

Under conditions in which offshore containers are transported and handled, the rate of wear and tear is high. An offshore container built to a recognised standard is designed, manufactured and tested to be able to withstand this wear and tear.

An offshore container is also designed with pad eyes to enable a suitably designed lifting set to be the recognised method of lifting offshore.



165

Offshore containers can be manufactured in many forms for many differing purposes. Some of the most common types of offshore container are illustrated below:



Offshore Waste Skip



Offshore Basket



Offshore Freight Container

### Offshore Container Essential Primary Structure

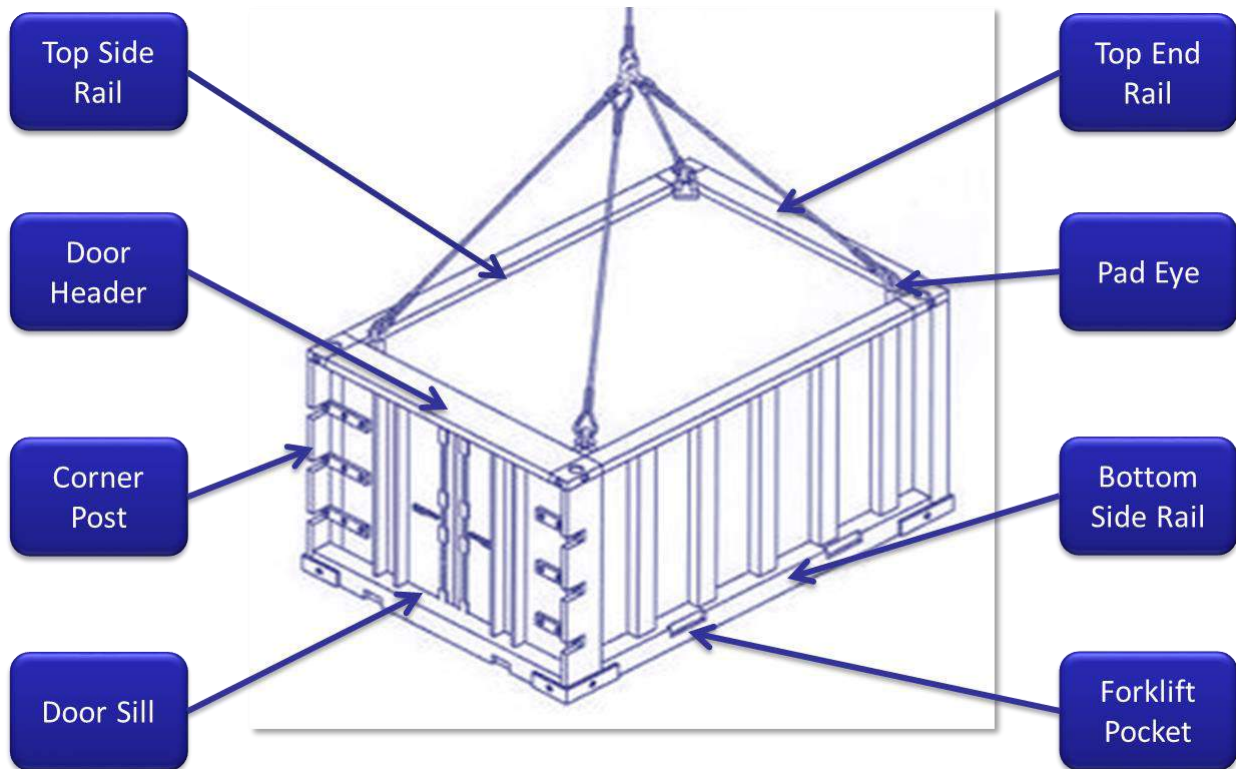

## Offshore Container Standards

The following list of standards are all applicable to offshore containers:

BS 7072: 1989 – British Standard code of practice for the inspection and repair of offshore containers (Withdrawn)

BS EN 12079-1: 2006 – Offshore containers - Design, manufacture and marking

BS EN 12079-2: 2006 – Offshore containers lifting sets - Design, manufacture and marking

BS EN 12079-3: 2006 – Offshore containers and lifting sets – Periodic inspection, examination and testing

Standard for Certification DNV 2.7-1: June 2013 – Offshore containers

ISO 10855 – Currently in draft stage of process only

## Offshore Container Data Plate Requirements

The offshore container plate shall contain the following information:

167

<b>Manufacturer's Serial Number</b>	<b>Manufacturer</b>	<b>Month/Year of Manufacture</b>	<b>Tare Mass</b>
-------------------------------------	---------------------	----------------------------------	------------------

<b>Maximum gross mass at design angle</b>	<b>Certificate of Conformity Number</b>	<b>Design Temperature</b>	<b>Payload</b>
---	---	---------------------------	----------------



## Lifting Set Requirements

The lifting set which is utilised for lifting the offshore container must be specifically designed for the maximum gross mass of the container to be lifted.

There are enhancement factors that must be taken into account when designing these lifting sets, due to the dynamic motions that an offshore container will experience when being lifted offshore.

There must also be a top leg (forerunner) fitted if the lifting set does not hang over the long side of a container to a specific height. This will ensure the rigger does not have to put themselves in danger by standing on top of a container.



## Pre-Trip Inspections

### Pre-Trip Inspection – Required Checks

- a) Inspection plate to ensure inspection dates are current
- b) Container for obvious signs of excessive corrosion or damage
- c) Lifting set for obvious signs of damage
- d) Lifting set to establish all parts are present, correct, properly connected and secure
- e) Container roof, fork pockets and frames on open frame containers for loose items
- f) Container doors are closed and the locking mechanism secured

Notes:

## 28. MOBILE CRANES

Mobile Cranes can be manufactured in many forms. The most common types of mobile crane are as illustrated:



**Yard Crane**

Yard crane used in factories and plants, small loads can be carried on platform.



**Truck Mounted Crane**

Truck mounted crane, multi use, fast relocation from job to job.



**Rough Terrain Crane**

Rough terrain crane; ideal for use on construction sites, easily relocates over rough ground and can pick and carry loads.

**Note:** Has to be transported by heavy transport if travelling long distance.



**City Crane**

City Crane; as the name suggests is designed to work in confined space of urban areas.

**Note:** Short boom sections.





**All Terrain Crane**

This is a popular model of crane. As the name suggests it is designed to travel over different types of terrain as well as being able to relocate at speed on highways from site to site.

### Typical Components of a Mobile Crane

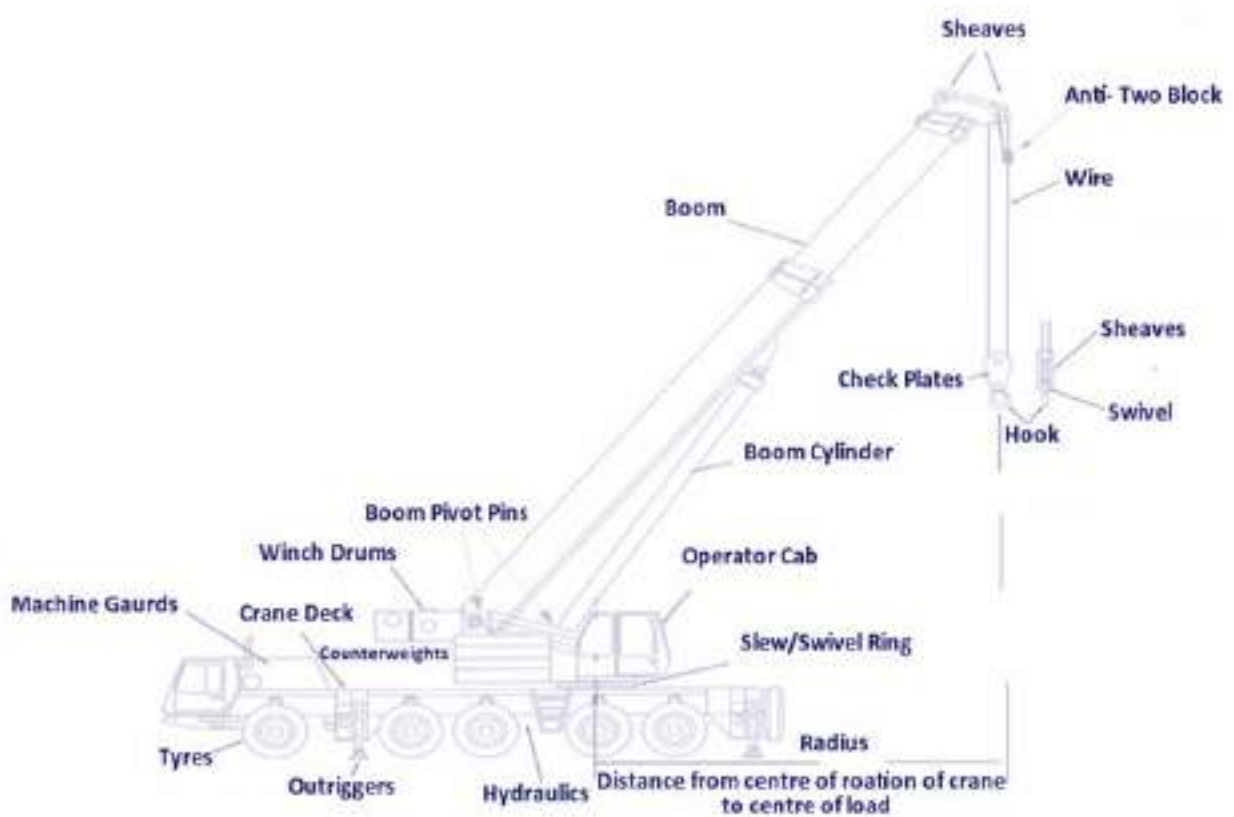

## Mobile Crane Operator Cab and Controls

Some cranes may still be fitted with mechanical levers;



Others may have dual joystick controls. All terrain cranes may be fitted with tilting cabs to reduce strain on operators neck when constantly looking up.



Notes:

## Feedback

We would be grateful for your feedback regarding these Step Notes, after completing this training course. Please make your comments known to us – you can use the note box below to list anything you would like to bring to our attention.

We value your views and will use your comments to help our continual improvement of our learning and development materials.

Thank you in advance for your participation.

*Andrew Wright*  
General Manager

Step Notes - feedback to LEEA: