

NFPA[®]

2001

**Standard on
Clean Agent Fire
Extinguishing Systems**

2018



IMPORTANT NOTICES AND DISCLAIMERS CONCERNING NFPA® STANDARDS

NOTICE AND DISCLAIMER OF LIABILITY CONCERNING THE USE OF NFPA STANDARDS

NFPA® codes, standards, recommended practices, and guides (“NFPA Standards”), of which the document contained herein is one, are developed through a consensus standards development process approved by the American National Standards Institute. This process brings together volunteers representing varied viewpoints and interests to achieve consensus on fire and other safety issues. While the NFPA administers the process and establishes rules to promote fairness in the development of consensus, it does not independently test, evaluate, or verify the accuracy of any information or the soundness of any judgments contained in NFPA Standards.

The NFPA disclaims liability for any personal injury, property, or other damages of any nature whatsoever, whether special, indirect, consequential or compensatory, directly or indirectly resulting from the publication, use of, or reliance on NFPA Standards. The NFPA also makes no guaranty or warranty as to the accuracy or completeness of any information published herein.

In issuing and making NFPA Standards available, the NFPA is not undertaking to render professional or other services for or on behalf of any person or entity. Nor is the NFPA undertaking to perform any duty owed by any person or entity to someone else. Anyone using this document should rely on his or her own independent judgment or, as appropriate, seek the advice of a competent professional in determining the exercise of reasonable care in any given circumstances.

The NFPA has no power, nor does it undertake, to police or enforce compliance with the contents of NFPA Standards. Nor does the NFPA list, certify, test, or inspect products, designs, or installations for compliance with this document. Any certification or other statement of compliance with the requirements of this document shall not be attributable to the NFPA and is solely the responsibility of the certifier or maker of the statement.

REVISION SYMBOLS IDENTIFYING CHANGES FROM THE PREVIOUS EDITION

Text revisions are shaded. A **Δ** before a section number indicates that words within that section were deleted and a **Δ** to the left of a table or figure number indicates a revision to an existing table or figure. When a chapter was heavily revised, the entire chapter is marked throughout with the **Δ** symbol. Where one or more sections were deleted, a **•** is placed between the remaining sections. Chapters, annexes, sections, figures, and tables that are new are indicated with an **N**.

Note that these indicators are a guide. Rearrangement of sections may not be captured in the markup, but users can view complete revision details in the First and Second Draft Reports located in the archived revision information section of each code at www.nfpa.org/docinfo. Any subsequent changes from the NFPA Technical Meeting, Tentative Interim Amendments, and Errata are also located there.

REMINDER: UPDATING OF NFPA STANDARDS

Users of NFPA codes, standards, recommended practices, and guides (“NFPA Standards”) should be aware that NFPA Standards may be amended from time to time through the issuance of a Tentative Interim Amendment (TIA) or corrected by Errata. An official NFPA Standard at any point in time consists of the current edition of the document together with any TIAs and Errata then in effect.

To determine whether an NFPA Standard has been amended through the issuance of Tentative Interim Amendments or corrected by Errata, go to www.nfpa.org/docinfo to choose from the list of NFPA Standards or use the search feature to select the NFPA Standard number (e.g., NFPA 13). The document information page provides up-to-date document-specific information as well as postings of all existing TIAs and Errata. It also includes the option to register for an “Alert” feature to receive an automatic email notification when new updates and other information are posted regarding the document.

IMPORTANT NOTICES AND DISCLAIMERS CONCERNING NFPA® STANDARDS

ADDITIONAL NOTICES AND DISCLAIMERS

Updating of NFPA Standards

Users of NFPA codes, standards, recommended practices, and guides (“NFPA Standards”) should be aware that these documents may be superseded at any time by the issuance of new editions or may be amended from time to time through the issuance of Tentative Interim Amendments or corrected by Errata. An official NFPA Standard at any point in time consists of the current edition of the document together with any Tentative Interim Amendments and any Errata then in effect. In order to determine whether a given document is the current edition and whether it has been amended through the issuance of Tentative Interim Amendments or corrected through the issuance of Errata, consult appropriate NFPA publications such as the National Fire Codes® Subscription Service, visit the NFPA website at www.nfpa.org, or contact the NFPA at the address listed below.

Interpretations of NFPA Standards

A statement, written or oral, that is not processed in accordance with Section 6 of the Regulations Governing the Development of NFPA Standards shall not be considered the official position of NFPA or any of its Committees and shall not be considered to be, nor be relied upon as, a Formal Interpretation.

Patents

The NFPA does not take any position with respect to the validity of any patent rights referenced in, related to, or asserted in connection with an NFPA Standard. The users of NFPA Standards bear the sole responsibility for determining the validity of any such patent rights, as well as the risk of infringement of such rights, and the NFPA disclaims liability for the infringement of any patent resulting from the use of or reliance on NFPA Standards.

NFPA adheres to the policy of the American National Standards Institute (ANSI) regarding the inclusion of patents in American National Standards (“the ANSI Patent Policy”), and hereby gives the following notice pursuant to that policy:

NOTICE: The user’s attention is called to the possibility that compliance with an NFPA Standard may require use of an invention covered by patent rights. NFPA takes no position as to the validity of any such patent rights or as to whether such patent rights constitute or include essential patent claims under the ANSI Patent Policy. If, in connection with the ANSI Patent Policy, a patent holder has filed a statement of willingness to grant licenses under these rights on reasonable and nondiscriminatory terms and conditions to applicants desiring to obtain such a license, copies of such filed statements can be obtained, on request, from NFPA. For further information, contact the NFPA at the address listed below.

Law and Regulations

Users of NFPA Standards should consult applicable federal, state, and local laws and regulations. NFPA does not, by the publication of its codes, standards, recommended practices, and guides, intend to urge action that is not in compliance with applicable laws, and these documents may not be construed as doing so.

Copyrights

NFPA Standards are copyrighted. They are made available for a wide variety of both public and private uses. These include both use, by reference, in laws and regulations, and use in private self-regulation, standardization, and the promotion of safe practices and methods. By making these documents available for use and adoption by public authorities and private users, the NFPA does not waive any rights in copyright to these documents.

Use of NFPA Standards for regulatory purposes should be accomplished through adoption by reference. The term “adoption by reference” means the citing of title, edition, and publishing information only. Any deletions, additions, and changes desired by the adopting authority should be noted separately in the adopting instrument. In order to assist NFPA in following the uses made of its documents, adopting authorities are requested to notify the NFPA (Attention: Secretary, Standards Council) in writing of such use. For technical assistance and questions concerning adoption of NFPA Standards, contact NFPA at the address below.

For Further Information

All questions or other communications relating to NFPA Standards and all requests for information on NFPA procedures governing its codes and standards development process, including information on the procedures for requesting Formal Interpretations, for proposing Tentative Interim Amendments, and for proposing revisions to NFPA standards during regular revision cycles, should be sent to NFPA headquarters, addressed to the attention of the Secretary, Standards Council, NFPA, 1 Batterymarch Park, P.O. Box 9101, Quincy, MA 02269-9101; email: stds_admin@nfpa.org.

For more information about NFPA, visit the NFPA website at www.nfpa.org. All NFPA codes and standards can be viewed at no cost at www.nfpa.org/docinfo.

Copyright © 2017 National Fire Protection Association®. All Rights Reserved.

NFPA® 2001

Standard on

Clean Agent Fire Extinguishing Systems

2018 Edition

This edition of NFPA 2001, *Standard on Clean Agent Fire Extinguishing Systems*, was prepared by the Technical Committee on Gaseous Fire Extinguishing Systems. It was issued by the Standards Council on November 10, 2017, with an effective date of November 30, 2017, and supersedes all previous editions.

This edition of NFPA 2001 was approved as an American National Standard on November 30, 2017.

Origin and Development of NFPA 2001

The Technical Committee on Halon Alternative Protection Options was organized in 1991 and immediately started work to address the new total flooding clean agents that were being developed to replace Halon 1301. A need existed for an explanation of how to design, install, maintain, and operate systems using these new clean agents, and NFPA 2001 was established to address that need. The 1994 edition was the first edition of NFPA 2001. The standard was revised in 1996, 2000, and 2004.

In January 2005, the technical committees responsible for NFPA 12, NFPA 12A, and NFPA 2001 were combined into the Technical Committee on Gaseous Fire Extinguishing Systems to better address and resolve issues among those documents. This action was intended to facilitate correlation and consistency as requested by the U.S. Environmental Protection Agency.

The 2008 edition added requirements for local application systems.

The 2012 edition included a complete rewrite of Annex C. In addition, more information on the environmental impact of clean agents was added to Annex A.

The 2015 edition added new content regarding recycling and disposal of clean agents and new system design criteria for 200 bar and 300 bar IG-01 systems. A sample system acceptance report was added to aid in conformance with commissioning practices. The committee completed an update of all references and reviewed the pipe design criteria against the referenced piping code. That edition also revised the requirements for cylinder location, enclosure integrity, and unoccupied spaces.

For the 2018 edition, the chapter on inspection, testing, maintenance, and training was completely reorganized to improve usability of the standard and to comply with the *Manual of Style for NFPA Technical Committee Documents*. As part of this revision, the content was split into two distinct chapters: Chapter 7, Approval of Installations, and Chapter 8, Inspection, Servicing, Testing, Maintenance, and Training. Definitions of *inspection*, *maintenance*, and *service* were added, as well as a requirement for integrated fire protection and life safety systems to be tested in accordance with NFPA 4. In addition, the standard now requires an egress time study for all clean agent systems, not just those where the design concentration is greater than the NOAEL. A definition of *abort switch* was added, and the definition of *clean agent* was revised. A requirement to install dirt traps at the end of each pipe run was added. The requirements for pipe and fittings were reviewed and updated in accordance with the latest reference standards. A new section on pipe hangers and supports was added. New requirements regarding releasing panels were added.

Technical Committee on Gaseous Fire Extinguishing Systems

Brent S. Ehmke, *Chair*
Ehmke Associates, NC [SE]

Ronald C. Adcock, *Secretary*
Marsh Risk Consulting, AZ [I]

Katherine Adrian, Tyco Fire Suppression & Building Products, WI [M]

Paul Anastasia, American International Group, Inc. (AIG), MA [I]

Oded Aron, Port Authority of New York & New Jersey, NY [U]

John E. Dellogono, Liberty Mutual Property, MA [I]

Todd A. Dillon, Global Asset Protection Services, LLC, OH [I]

Laurence E. Fisher, U.S. Coast Guard, DC [E]

William A. Froh, U.S. Department of Energy, DC [U]

Raymond N. Hansen, U.S. Department of the Air Force, FL [E]

Jeffrey L. Harrington, Harrington Group, Inc., GA [SE]

Mark E. Herzog, The Hiller Companies, AL [IM]

Scott A. Hill, JENSEN HUGHES, MD [SE]

Steven Hodges, Alion Science And Technology, CA [U]

W. David Hoffman, Firetrace International, AZ [M]

Giuliano Indovino, North American Fire Guardian Technology, Inc., Italy [M]

Robert Kasiski, FM Global, MA [I]

Norbert W. Makowka, National Association of Fire Equipment Distributors, IL [IM]

Rep. National Association of Fire Equipment Distributors

Bella A. Maranion, U.S. Environmental Protection Agency, DC [E]

Robert G. Richard, Honeywell, Inc., NY [M]

Paul E. Rivers, 3M Company, MN [M]

Mark L. Robin, Chemours, DE [M]

Joseph A. Senecal, Kidde-Fenwal, Inc., MA [M]

Blake M. Shugarman, UL LLC, IL [RT]

John C. Spalding, Healey Fire Protection, Inc., MI [M]

Rep. Fire Suppression Systems Association

Brad T. Stilwell, Fike Corporation, MO [M]

Robert T. Wickham, Wickham Associates, NH [SE]

Thomas J. Wysocki, Guardian Services, Inc., IL [SE]

Alternates

Maurizio Barbuzzi, North American Fire Guardian Technology, Inc., Italy [M]

(Alt. to Giuliano Indovino)

Charles O. Bauroth, Liberty Mutual, MA [I]

(Alt. to John E. Dellogono)

Thomas A. Downey, Marsh Risk Consulting, CT [I]

Mark E. Fessenden, Tyco Fire Protection Products, WI [M]

(Alt. to Katherine Adrian)

Eric W. Forssell, JENSEN HUGHES, MD [SE]

(Alt. to Scott A. Hill)

Ryan Gamboa, Firetrace USA, AZ [M]

(Alt. to W. David Hoffman)

Kevin Holly, Jr., UL LLC, IL [RT]

(Alt. to Blake M. Shugarman)

Daniel J. Hubert, Amerex/Janus Fire Systems, IN [M]

(Alt. to John C. Spalding)

Jonathan G. Ingram, Kidde-Fenwal, Inc., MA [M]

(Alt. to Joseph A. Senecal)

Jeffrey S. Kidd, The Hiller Companies, MA [IM]

(Alt. to Mark E. Herzog)

Justin D. Merrick, S&S Sprinkler Company, LLC, AL [M]

Michael Lee Moberly, BP Upstream Engineering Center, TX [U]

Earl D. Nearing, Fike Corporation, MO [M]

(Alt. to Brad T. Stilwell)

John G. Owens, 3M Company, MN [M]

(Alt. to Paul E. Rivers)

James M. Rucci, Harrington Group, Inc., GA [SE]

(Alt. to Jeffrey L. Harrington)

Raymond A. Stacy, FM Approvals, MA [I]

(Alt. to Robert Kasiski)

Sangeetha Subramanian, Honeywell, NJ [M]

(Alt. to Robert G. Richard)

Charles Taylor, U.S. Coast Guard, DC [E]

(Alt. to Laurence E. Fisher)

Alfred J. Thornton, The Chemours Company, DE [M]

(Alt. to Mark L. Robin)

Todd W. VanGorder, Silco Fire & Security, OH [IM]

(Alt. to Norbert W. Makowka)

Nonvoting

Ingeborg Schlosser, VdS Schadenverhuetung, Germany [I]

Fernando Vigara, APICI, Spain [SE]

Barry D. Chase, NFPA Staff Liaison

This list represents the membership at the time the Committee was balloted on the final text of this edition. Since that time, changes in the membership may have occurred. A key to classifications is found at the back of the document.

NOTE: Membership on a committee shall not in and of itself constitute an endorsement of the Association or any document developed by the committee on which the member serves.

Committee Scope: This committee shall have primary responsibility for documents on the installation, maintenance, and use of carbon dioxide systems for fire protection.

This committee shall also have primary responsibility for documents on fixed fire extinguishing systems utilizing bromotrifluoromethane and other similar halogenated extinguishing agents, covering the installation, maintenance, and use of systems.

This committee shall also have primary responsibility for documents on alternative protection options to Halon 1301 and 1211 fire extinguishing systems. It shall not deal with design, installation, operation, testing, and maintenance of systems employing dry chemical, wet chemical, foam, aerosols, or water as the primary extinguishing media.

Contents

Chapter 1 Administration	2001– 5	7.5 Review of Enclosure Integrity.	2001– 23
1.1 Scope.	2001– 5	7.6 Review of Electrical Components.	2001– 23
1.2 Purpose.	2001– 5	7.7 Functional Testing.	2001– 24
1.3 Units.	2001– 5	7.8 Owner’s Documentation.	2001– 25
1.4 General Information.	2001– 5	7.9 Training.	2001– 25
1.5 Safety.	2001– 6		
1.6 Environmental Factors.	2001– 9		
1.7 Retrofitability.	2001– 9		
1.8 Compatibility with Other Agents.	2001– 9		
Chapter 2 Referenced Publications	2001– 9	Chapter 8 Inspection, Servicing, Testing, Maintenance, and Training	2001– 25
2.1 General.	2001– 9	8.1 General.	2001– 25
2.2 NFPA Publications.	2001– 9	8.2 Monthly Inspection.	2001– 25
2.3 Other Publications.	2001– 9	8.3 Semiannual Service and Inspection.	2001– 25
2.4 References for Extracts in Mandatory Sections.	2001– 10	8.4 Annual Inspection and Service.	2001– 26
		8.5 Maintenance.	2001– 26
		8.6 Container Test.	2001– 26
		8.7 Hose Test.	2001– 26
		8.8 Training.	2001– 26
Chapter 3 Definitions	2001– 10	Chapter 9 Marine Systems	2001– 27
3.1 General.	2001– 10	9.1 General.	2001– 27
3.2 NFPA Official Definitions.	2001– 10	9.2 Use and Limitations.	2001– 27
3.3 General Definitions.	2001– 10	9.3 Hazards to Personnel.	2001– 27
Chapter 4 Components	2001– 11	9.4 Agent Supply.	2001– 27
4.1 Agent Supply.	2001– 11	9.5 Detection, Actuation, and Control Systems. ...	2001– 27
4.2 Distribution.	2001– 12	9.6 Additional Requirements for Systems Protecting Class B Hazards Greater Than 6000 ft ³ (170 m ³) with Stored Cylinders Within the Protected Space.	2001– 28
4.3 Detection, Actuation, Alarm, and Control Systems.	2001– 15	9.7 Enclosure.	2001– 28
Chapter 5 System Design	2001– 17	9.8 Design Concentration Requirements.	2001– 28
5.1 Specifications, Plans, and Approvals.	2001– 17	9.9 Distribution System.	2001– 29
5.2 System Flow Calculations.	2001– 18	9.10 Nozzle Choice and Location.	2001– 29
5.3 Enclosure.	2001– 18	9.11 Inspection and Tests.	2001– 29
5.4 Design Concentration Requirements.	2001– 19	9.12 Approval of Installations.	2001– 29
5.5 Total Flooding Quantity.	2001– 19	9.13 Periodic Puff Testing.	2001– 29
5.6 Duration of Protection.	2001– 21	9.14 Compliance.	2001– 29
5.7 Distribution System.	2001– 21		
5.8 Nozzle Choice and Location.	2001– 21	Annex A Explanatory Material	2001– 29
Chapter 6 Local Application Systems	2001– 21	Annex B Cup Burner Method for Determining the Minimum Concentration of Gaseous Agent for Flame Extinguishment	2001– 94
6.1 Description.	2001– 21	Annex C Enclosure Integrity Procedure	2001– 105
6.2 Hazard Specifications.	2001– 22	Annex D Enclosure Evaluation	2001– 114
6.3 Clean Agent Requirements.	2001– 22	Annex E Informational References	2001– 115
6.4 Nozzles.	2001– 22	Index	2001– 119
6.5 Location and Number of Nozzles.	2001– 22		
6.6 Operation.	2001– 22		
Chapter 7 Approval of Installations	2001– 22		
7.1 Safety.	2001– 22		
7.2 General.	2001– 22		
7.3 Acceptance Test Report.	2001– 23		
7.4 Review of Mechanical Components.	2001– 23		

NFPA 2001

Standard on

Clean Agent Fire Extinguishing Systems

2018 Edition

IMPORTANT NOTE: This NFPA document is made available for use subject to important notices and legal disclaimers. These notices and disclaimers appear in all publications containing this document and may be found under the heading “Important Notices and Disclaimers Concerning NFPA Standards.” They can also be viewed at www.nfpa.org/disclaimers or obtained on request from NFPA.

UPDATES, ALERTS, AND FUTURE EDITIONS: New editions of NFPA codes, standards, recommended practices, and guides (i.e., NFPA Standards) are released on scheduled revision cycles. This edition may be superseded by a later one, or it may be amended outside of its scheduled revision cycle through the issuance of Tentative Interim Amendments (TIAs). An official NFPA Standard at any point in time consists of the current edition of the document, together with all TIAs and Errata in effect. To verify that this document is the current edition or to determine if it has been amended by TIAs or Errata, please consult the National Fire Codes® Subscription Service or the “List of NFPA Codes & Standards” at www.nfpa.org/docinfo. In addition to TIAs and Errata, the document information pages also include the option to sign up for alerts for individual documents and to be involved in the development of the next edition.

NOTICE: An asterisk (*) following the number or letter designating a paragraph indicates that explanatory material on the paragraph can be found in Annex A.

A reference in brackets [] following a section or paragraph indicates material that has been extracted from another NFPA document. As an aid to the user, the complete title and edition of the source documents for extracts in mandatory sections of the document are given in Chapter 2 and those for extracts in informational sections are given in Annex E. Extracted text may be edited for consistency and style and may include the revision of internal paragraph references and other references as appropriate. Requests for interpretations or revisions of extracted text shall be sent to the technical committee responsible for the source document.

Information on referenced publications can be found in Chapter 2 and Annex E.

Chapter 1 Administration

1.1 Scope. This standard contains minimum requirements for total flooding and local application clean agent fire extinguishing systems. It does not cover fire extinguishing systems that use carbon dioxide or water as the primary extinguishing media, which are addressed by other NFPA documents.

1.2 Purpose.

1.2.1 The agents in this standard were introduced in response to international restrictions on the production of certain halon fire extinguishing agents under the Montreal Protocol signed September 16, 1987, as amended. This standard is prepared for the use by and guidance of those charged with purchasing, designing, installing, testing, inspecting, approving, listing, operating, and maintaining engineered or pre-engineered clean agent extinguishing systems, so that such equipment will function as intended throughout its life. Nothing in this stand-

ard is intended to restrict new technologies or alternative arrangements provided the level of safety prescribed by this standard is not lowered.

1.2.2 No standard can be promulgated that will provide all the necessary criteria for the implementation of a total flooding clean agent fire extinguishing system. Technology in this area is under constant development, and this will be reflected in revisions to this standard. The user of this standard must recognize the complexity of clean agent fire extinguishing systems. Therefore, the designer is cautioned that the standard is not a design handbook. The standard does not do away with the need for the engineer or for competent engineering judgment. It is intended that a designer capable of applying a more complete and rigorous analysis to special or unusual problems shall have latitude in the development of such designs. In such cases, the designer is responsible for demonstrating the validity of the approach.

1.3 Units. Metric units of measurement in this standard are in accordance with the modernized metric system known as the International System of Units (SI). Two units outside of but recognized by SI (liter and bar) are commonly used in international fire protection. The SI units and their conversion factors are listed in Table 1.3. If a value for measurement as given in this standard is followed by an equivalent value in other units, the first stated is to be regarded as the requirement. A given equivalent value could be approximate.

Table 1.3 Metric Conversion Factors

Name of Unit	Unit Symbol	Conversion Factor
millimeter	mm	1 in. = 25.4 mm
liter	L	1 gal = 3.785 L
cubic meter	m ³	1 ft ³ = 0.028317 m ³
kilogram	kg	1 lb = 0.4536 kg
kilograms per cubic meter	kg/m ³	1 lb/ft ³ = 16.0185 kg/m ³
pascal	Pa	1 psi = 6895 Pa
bar	bar	1 psi = 0.0689 bar
bar	bar	1 bar = 10 ⁵ Pa

Notes:

(1) For additional conversions and information, see ASTM SI10.

1.4 General Information.**1.4.1* Applicability of Agents.**

1.4.1.1 The fire extinguishing agents addressed in this standard shall be electrically nonconducting and leave no residue upon evaporation.

1.4.1.2* Agents that meet the criteria of 1.4.1.1 shall be shown in Table 1.4.1.2.

1.4.1.3 The design, installation, service, and maintenance of clean agent systems shall be performed by those skilled in clean agent fire extinguishing system technology.

1.4.2* Use and Limitations.

1.4.2.1 All pre-engineered systems shall be installed to protect hazards within the limitations that have been established by the

listing. Pre-engineered systems shall be listed to one of the following types:

- (1) Those consisting of system components designed to be installed according to pre-tested limitations by a testing laboratory. These pre-engineered systems shall be permitted to incorporate special nozzles, flow rates, methods of application, nozzle placement, and pressurization levels that could differ from those detailed elsewhere in this standard. All other requirements of the standard shall apply.
- (2) Automatic extinguishing units incorporating special nozzles, flow rates, methods of application, nozzle placement, actuation techniques, piping materials, discharge times, mounting techniques, and pressurization levels that could differ from those detailed elsewhere in this standard.

1.4.2.2 Clean agents shall not be used on fires involving the following materials unless the agents have been tested to the satisfaction of the authority having jurisdiction:

- (1) Certain chemicals or mixtures of chemicals, such as cellulose nitrate and gunpowder, which are capable of rapid oxidation in the absence of air

- (2) Reactive metals such as lithium, sodium, potassium, magnesium, titanium, zirconium, uranium, and plutonium
- (3) Metal hydrides
- (4) Chemicals capable of undergoing autothermal decomposition, such as certain organic peroxides, pyrophoric materials, and hydrazine

1.4.2.3* Where a total flooding system is used, a fixed enclosure shall be provided about the hazard that allows a specified agent concentration to be achieved and maintained for a specified period of time.

1.4.2.4* The effects of agent decomposition on fire protection effectiveness and equipment shall be considered where clean agents are used in hazards with high ambient temperatures (e.g., furnaces and ovens).

1.5 Safety.

1.5.1* Hazards to Personnel.

1.5.1.1* Any agent that is to be recognized by this standard or proposed for inclusion in this standard shall first be evaluated in a manner equivalent to the process used by the U.S. Environmental Protection Agency (EPA) Significant New Alternatives Policy (SNAP) Program for total flooding agents.

▲ **Table 1.4.1.2 Agents Addressed in NFPA 2001**

Agent Designation	Chemical Name	Chemistry
FK-5-1-12	Dodecafluoro-2-methylpentan-3-one	$\text{CF}_3\text{CF}_2\text{C}(\text{O})\text{CF}(\text{CF}_3)_2$
HCFC Blend A	Dichlorotrifluoroethane HCFC-123 (4.75%)	CHCl_2CF_3
	Chlorodifluoromethane HCFC-22 (82%)	CHClF_2
	Chlorotetrafluoroethane HCFC-124 (9.5%)	CHClFCF_3
	Isopropenyl-1-methylcyclohexene (3.75%)	
HCFC-124	Chlorotetrafluoroethane	CHClFCF_3
HFC-125	Pentafluoroethane	CHF_2CF_3
HFC-227ea	Heptafluoropropane	$\text{CF}_3\text{CHFCF}_3$
HFC-23	Trifluoromethane	CHF_3
HFC-236fa	Hexafluoropropane	$\text{CF}_3\text{CH}_2\text{CF}_3$
FIC-1311	Trifluoroiodide	CF_3I
IG-01	Argon	Ar
IG-100	Nitrogen	N_2
IG-541	Nitrogen (52%)	N_2
	Argon (40%)	Ar
	Carbon dioxide (8%)	CO_2
IG-55	Nitrogen (50%)	N_2
	Argon (50%)	Ar
HFC Blend B	Tetrafluoroethane (86%)	CH_2FCF_3
	Pentafluoroethane (9%)	CHF_2CF_3
	Carbon dioxide (5%)	CO_2

Notes:

- (1) Other agents could become available at later dates. They could be added via the NFPA process in future editions or by amendments to the standard.
- (2) Composition of inert gas agents is given in percent by volume. Composition of HCFC Blend A is given in percent by weight.
- (3) The full analogous ASHRAE nomenclature for FK-5-1-12 is FK-5-1-12mmy2.

1.5.1.2* Halocarbon Agents.

Δ 1.5.1.2.1* Unnecessary exposure to halocarbon clean agents — including exposure at and below the no observable adverse effects level (NOAEL) — and halocarbon decomposition products shall be avoided. Means shall be provided to limit exposure to no longer than 5 minutes. Unprotected personnel shall not enter a protected space during or after agent discharge. The following additional provisions shall apply:

- (1) Halocarbon systems for spaces that are normally occupied and designed to concentrations up to the NOAEL [see Table 1.5.1.2.1(a)] shall be permitted. The maximum exposure in any case shall not exceed 5 minutes.
- (2) Halocarbon systems for spaces that are normally occupied and designed to concentrations above the NOAEL [see Table 1.5.1.2.1(a)] shall be permitted if means are provided to limit exposure to the design concentrations shown in Table 1.5.1.2.1(b) through Table 1.5.1.2.1(e) that correspond to an allowable human exposure time of 5 minutes. Higher design concentrations associated with human exposure times less than 5 minutes as shown in Table 1.5.1.2.1(b) through Table 1.5.1.2.1(e) shall not be permitted in normally occupied spaces.
- (3) In spaces that are not normally occupied and protected by a halocarbon system designed to concentrations above the lowest observable adverse effects level (LOAEL) [see Table 1.5.1.2.1(a)] and where personnel could possibly be exposed, means shall be provided to limit exposure times using Table 1.5.1.2.1(b) through Table 1.5.1.2.1(e).
- (4) In spaces that are not normally occupied and in the absence of the information needed to fulfill the conditions listed in 1.5.1.2.1(3), the following provisions shall apply:
 - (a) Where egress takes longer than 30 seconds but less than 1 minute, the halocarbon agent shall not be used in a concentration exceeding its LOAEL.
 - (b) Concentrations exceeding the LOAEL shall be permitted provided that any personnel in the area can escape within 30 seconds.
 - (c) A pre-discharge alarm and time delay shall be provided in accordance with the provisions of 4.3.5.6 of this standard.

1.5.1.3* Inert Gas Clean Agents. Unnecessary exposure to inert gas agent systems resulting in low oxygen atmospheres shall be avoided. The maximum exposure time in any case shall not exceed 5 minutes. See Table 5.5.3.3 for atmospheric correction factors that shall be considered when determining the design concentrations. One objective of pre-discharge alarms

and time delays is to prevent human exposure to agents. A pre-discharge alarm and time delay shall be provided in accordance with the provisions of 4.3.5.6 of this standard. Unprotected personnel shall not enter the area during or after agent discharge. The following additional provisions shall apply:

- (1) Inert gas systems designed to concentrations below 43 percent (corresponding to an oxygen concentration of 12 percent, sea level equivalent of oxygen) shall be permitted where means are provided to limit exposure to no longer than 5 minutes.
- (2) Inert gas systems designed to concentrations between 43 and 52 percent (corresponding to between 12 and 10 percent oxygen, sea level equivalent of oxygen) shall be permitted where means are provided to limit exposure to no longer than 3 minutes.

Δ Table 1.5.1.2.1(b) Time for Safe Human Exposure at Stated Concentrations for HFC-125

HFC-125 Concentration		Maximum Permitted Human Exposure Time (min)
vol %	ppm	
7.5	75,000	5.00
8.0	80,000	5.00
8.5	85,000	5.00
9.0	90,000	5.00
9.5	95,000	5.00
10.0	100,000	5.00
10.5	105,000	5.00
11.0	110,000	5.00
11.5	115,000	5.00
12.0	120,000	1.67
12.5	125,000	0.59
13.0	130,000	0.54
13.5	135,000	0.49

Notes:

- (1) Data derived from the EPA-approved and peer-reviewed physiologically based pharmacokinetic (PBPK) model or its equivalent.
- (2) Based on LOAEL of 10.0 percent in dogs.

Δ Table 1.5.1.2.1(c) Time for Safe Human Exposure at Stated Concentrations for HFC-227ea

HFC-227ea Concentration		Maximum Permitted Human Exposure Time (min)
vol %	ppm	
9.0	90,000	5.00
9.5	95,000	5.00
10.0	100,000	5.00
10.5	105,000	5.00
11.0	110,000	1.13
11.5	115,000	0.60
12.0	120,000	0.49

Notes:

- (1) Data derived from the EPA-approved and peer-reviewed PBPK model or its equivalent.
- (2) Based on LOAEL of 10.5 percent in dogs.

Δ Table 1.5.1.2.1(a) Information for Halocarbon Clean Agents

Agent	NOAEL (vol %)	LOAEL (vol %)
FK-5-1-12	10.0	>10.0
HCFC Blend A	10.0	>10.0
HCFC-124	1.0	2.5
HFC-125	7.5	10.0
HFC-227ea	9.0	10.5
HFC-23	30	>30
HFC-236fa	10	15
HFC Blend B*	5.0*	7.5*

*These values are for the largest component of the blend (HFC 134A).

▲ **Table 1.5.1.2.1(d) Time for Safe Human Exposure at Stated Concentrations for HFC-236fa**

HFC-236fa Concentration		Maximum Permitted Human Exposure Time (min)
vol %	ppm	
10.0	100,000	5.00
10.5	105,000	5.00
11.0	110,000	5.00
11.5	115,000	5.00
12.0	120,000	5.00
12.5	125,000	5.00
13.0	130,000	1.65
13.5	135,000	0.92
14.0	140,000	0.79
14.5	145,000	0.64
15.0	150,000	0.49

Notes:

- (1) Data derived from the EPA-approved and peer-reviewed PBPK model or its equivalent.
- (2) Based on LOAEL of 15.0 percent in dogs.

▲ **Table 1.5.1.2.1(e) Time for Safe Human Exposure at Stated Concentrations for FIC-131I**

FIC-131I Concentration		Maximum Permitted Human Exposure Time (min)
vol %	ppm	
0.20	2000	5.00
0.25	2500	5.00
0.30	3000	5.00
0.35	3500	4.30
0.40	4000	0.85
0.45	4500	0.49
0.50	5000	0.35

Notes:

- (1) Data derived from the EPA-approved and peer-reviewed PBPK model or its equivalent.
- (2) Based on LOAEL of 0.4 percent in dogs.
- (3) Inert gas systems designed to concentrations between 52 and 62 percent (corresponding to between 10 and 8 percent oxygen, sea level equivalent of oxygen) shall be permitted given the following:
 - (a) The space is normally unoccupied.
 - (b) Where personnel could possibly be exposed, means are provided to limit the exposure to less than 30 seconds.
- (4) Inert gas systems designed to concentrations above 62 percent (corresponding to 8 percent oxygen or below, sea level equivalent of oxygen) shall be used only in unoccupied areas where personnel are not exposed to such oxygen depletion.

■ **1.5.1.4*** An egress time study shall be performed to verify that the maximum exposure time limits in 1.5.1.2.1 and 1.5.1.3 are achieved.

1.5.1.5 Safety Requirements.

1.5.1.5.1* Suitable safeguards shall be provided to ensure prompt evacuation of and prevent entry into hazardous atmospheres and also to provide means for prompt rescue of any trapped personnel. Safety items such as personnel training, warning signs, discharge alarms, self-contained breathing apparatus (SCBA), evacuation plans, and fire drills shall be considered.

1.5.1.5.2* Consideration shall be given to the possibility of a clean agent migrating to adjacent areas outside of the protected space.

1.5.1.5.3 For systems protecting occupiable enclosures or spaces where the clean agent design concentration exceeds that approved for use in normally occupied spaces (see Section 1.5), systems shall include the following:

- (1) Supervised system lockout valves
- (2) Pneumatic pre-discharge alarms
- (3) Pneumatic time delays
- (4) Warning signs

1.5.1.5.4* Pneumatic pre-discharge alarms shall be operated by an inert gas. For an inert gas clean agent fire extinguishing system, the quantity of inert gas discharged to operate a pneumatic pre-discharge alarm discharging into the protected space shall be considered, together with the quantity of agent discharged, when making a determination of post-discharge oxygen concentration with respect to compliance with the requirements of 1.5.1.3.

1.5.1.6 All persons who inspect, test, maintain, or operate fire extinguishing systems shall be trained in all aspects of safety related to the systems.

1.5.1.6.1 Before system cylinders are handled or moved, the following steps shall be taken:

- (1) Cylinder outlets shall be fitted with anti-recoil devices, cylinder caps, or both whenever the cylinder outlet is not connected to the system pipe inlet.
- (2) Actuators shall be disabled or removed before cylinders are removed from retaining bracketing.

1.5.1.6.2 Safe handling procedures shall be followed when transporting system cylinders.

1.5.1.6.2.1 Equipment designed for transporting cylinders shall be used. When dollies or carts are used, cylinders shall be secured.

1.5.1.6.2.2 The system manufacturer's service procedures shall be followed for specific details on system operation, maintenance, and safety considerations.

1.5.2 Electrical Clearances.

1.5.2.1 All system components shall be located to maintain no less than minimum clearances from energized electrical parts. The following references shall be considered as the minimum electrical clearance requirements for the installation of clean agent systems:

- (1) **IEEE C2**, *National Electrical Safety Code*
- (2) **NFPA 70**, *National Electrical Code*
- (3) 29 CFR 1910, Subpart S, "Electrical Engineering"

1.5.2.2 Where the design basic insulation level (BIL) is not available and where nominal voltage is used for the design

criteria, the highest minimum clearance listed for this group shall be used.

1.5.2.3 The selected clearance to ground shall satisfy the greater of the switching surge or BIL duty, rather than being based on nominal voltage.

1.5.2.4* The clearance between uninsulated, energized parts of the electrical system equipment and any portion of the clean agent system shall not be less than the minimum clearance provided elsewhere for electrical system insulation on any individual component.

1.5.2.5 Where BIL is not available and where nominal voltage is used for the design criteria, the highest minimum clearance listed for this group shall be used.

1.6* Environmental Factors. When an agent is being selected to protect a hazard area, the effects of the agent on the environment shall be considered. Selection of the appropriate fire suppression agent shall include consideration of the following items:

- (1) Potential environmental effect of a fire in the protected area
- (2) Potential environmental impacts, including, but not limited to, ozone depletion potential (ODP) and global warming potential (GWP) of the clean agents that could be used

1.7 Retrofitability. Retrofitting of any clean agent into an existing fire extinguishing system shall result in a system that is listed or approved.

1.8 Compatibility with Other Agents.

1.8.1* Mixing of agents in the same container shall be permitted only if the system is listed.

1.8.2 Systems employing the simultaneous discharge of different agents to protect the same enclosed space shall not be permitted.

Chapter 2 Referenced Publications

2.1 General. The documents or portions thereof listed in this chapter are referenced within this standard and shall be considered part of the requirements of this document.

2.2 NFPA Publications. National Fire Protection Association, 1 Batterymarch Park, Quincy, MA 02169-7471.

NFPA 4, *Standard for Integrated Fire Protection and Life Safety System Testing*, 2018 edition.

NFPA 70®, *National Electrical Code*®, 2017 edition.

NFPA 72®, *National Fire Alarm and Signaling Code*®, 2016 edition.

2.3 Other Publications.

2.3.1 ANSI Publications. American National Standards Institute, Inc., 25 West 43rd Street, 4th Floor, New York, NY 10036.

ANSI Z535.2, *Standard for Environmental and Facility Safety Signs*, 2011.

2.3.2 ASME Publications. American Society of Mechanical Engineers, Two Park Avenue, New York, NY 10016-5990.

ASME B1.20.1, *Standard on Pipe Threads, General Purpose, Inch*, 2013.

ASME B31.1, *Power Piping Code*, 2016.

Boiler and Pressure Vessel Code, 2017.

2.3.3 ASTM Publications. ASTM International, 100 Barr Harbor Drive, P.O. Box C700, West Conshohocken, PA 19428-2959.

ASTM A120, *Specification for Pipe, Steel, Black and Hot-Dipped (Galvanized) Welded and Seamless for Ordinary Uses*, 1984 (with-drawn 1987).

ASTM SI10, *American National Standard for Metric Practice*, 2016.

2.3.4 CGA Publications. Compressed Gas Association, 14501 George Carter Way, Suite 103, Chantilly, VA 20151-2923.

CGA C-6, *Standard for Visual Inspection of Steel Compressed Gas Cylinders*, 2013.

▲ **2.3.5 IEEE Publications.** IEEE Standards Association, 3 Park Avenue, 17th Floor, New York, NY 10016-5997.

IEEE C2, *National Electrical Safety Code*, 2017.

▲ **2.3.6 IMO Publications.** International Maritime Organization, 4, Albert Embankment, London, SE1 7SR, United Kingdom.

IMO MSC/Circ. 848, *Revised Guidelines for the Approval of Equivalent Fixed Gas Fire-Extinguishing Systems as Referred to in SOLAS 74, for Machinery Spaces and Cargo Pump-Rooms*, 1998.

IMO MSC.1/Circ.1267, *Amendments to Revised Guidelines for the Approval of Equivalent Fixed Gas Fire-Extinguishing Systems, as Referred to in SOLAS 74, for Machinery Spaces and Cargo Pump-Rooms (MSC/Circ.848)*, 2008.

2.3.7 ISO Publications. International Organization for Standardization, ISO Central Secretariat, BIBC II, Chemin de Blandinnet 8, CP 401, 1214 Vernier, Geneva, Switzerland.

ISO 7-1, *Pipe Threads Where Pressure-Tight Joints Are Made on the Threads — Part 1: Dimensions, Tolerances and Designation*, 2007.

2.3.8 TC Publications. Transport Canada, Tower C, Place de Ville, 330 Sparks Street, Ottawa, Ontario, K1A 0N5, Canada.

TP 127 E, *Ship Safety Electrical Standards*, 2008.

2.3.9 UL Publications. Underwriters Laboratories Inc., 333 Pfingsten Road, Northbrook, IL 60062-2096.

ANSI/UL 2127, *Standard for Inert Gas Clean Agent Extinguishing System Units*, 2012 (revised 2015).

ANSI/UL 2166, *Standard for Halocarbon Clean Agent Extinguishing System Units*, 2012 (revised 2015).

2.3.10 ULC Publications. Underwriters Laboratories of Canada, 7 Underwriters Road, Toronto, ON M1R 3B4, Canada.

CAN/ULC S524-14, *Standard for the Installation of Fire Alarm Systems*, 2014.

CAN/ULC S529-16, *Smoke Detectors for Fire Alarm Systems*, 2016.

2.3.11 U.S. Government Publications. U.S. Government Publishing Office, 732 North Capitol Street, NW, Washington, DC 20401-0001.

OSHA, Title 29, Code of Federal Regulations, Part 1910, Subpart S.

U.S. Coast Guard, Title 46, Code of Federal Regulations, Part 72.

U.S. Coast Guard, Title 46, Code of Federal Regulations, Subchapter J, “Electrical Engineering.”

DOT Title 49, Code of Federal Regulations, Parts 170–190, “Transportation.”

2.3.12 Other Publications.

Merriam-Webster’s Collegiate Dictionary, 11th edition, Merriam-Webster, Inc., Springfield, MA, 2003.

2.4 References for Extracts in Mandatory Sections.

NFPA 12, *Standard on Carbon Dioxide Extinguishing Systems*, 2018 edition.

Chapter 3 Definitions

3.1 General. The definitions contained in this chapter shall apply to the terms used in this standard. Where terms are not defined in this chapter or within another chapter, they shall be defined using their ordinarily accepted meanings within the context in which they are used. *Merriam-Webster’s Collegiate Dictionary*, 11th edition, shall be the source for the ordinarily accepted meaning.

3.2 NFPA Official Definitions.

3.2.1* Approved. Acceptable to the authority having jurisdiction.

3.2.2* Authority Having Jurisdiction (AHJ). An organization, office, or individual responsible for enforcing the requirements of a code or standard, or for approving equipment, materials, an installation, or a procedure.

3.2.3* Listed. Equipment, materials, or services included in a list published by an organization that is acceptable to the authority having jurisdiction and concerned with evaluation of products or services, that maintains periodic inspection of production of listed equipment or materials or periodic evaluation of services, and whose listing states that either the equipment, material, or service meets appropriate designated standards or has been tested and found suitable for a specified purpose.

3.2.4 Shall. Indicates a mandatory requirement.

3.2.5 Should. Indicates a recommendation or that which is advised but not required.

3.2.6 Standard. An NFPA Standard, the main text of which contains only mandatory provisions using the word “shall” to indicate requirements and that is in a form generally suitable for mandatory reference by another standard or code or for adoption into law. Nonmandatory provisions are not to be considered a part of the requirements of a standard and shall be located in an appendix, annex, footnote, informational note, or other means as permitted in the NFPA Manuals of Style. When used in a generic sense, such as in the phrase

“standards development process” or “standards development activities,” the term “standards” includes all NFPA Standards, including Codes, Standards, Recommended Practices, and Guides.

3.3 General Definitions.

3.3.1* Abort Switch. A system control that, when operated during the releasing panel’s release delay countdown, extends the delay in accordance with a predetermined effect.

3.3.2 Adjusted Minimum Design Quantity (AMDQ). The minimum design quantity of agent that has been adjusted in consideration of design factors.

3.3.3 Agent Concentration. The portion of agent in an agent-air mixture expressed in volume percent.

3.3.4 Class A Fire. A fire in ordinary combustibles, such as wood, cloth, paper, rubber, and many plastics.

3.3.5 Class B Fire. A fire in flammable liquids, combustible liquids, petroleum greases, tars, oils, oil-based paints, solvents, lacquers, alcohols, and flammable gases.

3.3.6 Class C Fire. A fire that involves energized electrical equipment.

3.3.7* Clean Agent. Volatile or gaseous fire extinguishant that is electrically nonconducting and that does not leave a residue upon evaporation.

3.3.8 Clearance. The air distance between extinguishing system equipment, including piping and nozzles, and unenclosed or uninsulated live electrical components not at ground potential.

3.3.9 Control Room and Electronic Equipment Space. A space containing electronic or electrical equipment, such as that found in control rooms or electronic equipment rooms, where only Class A surface fires or Class C electrical hazards are present.

3.3.10 Design Concentration.

3.3.10.1* Adjusted Minimum Design Concentration (AMDC). The target minimum design concentration after the safety factor and the design factors have been taken into account.

3.3.10.2* Final Design Concentration (FDC). The actual concentration of agent discharged into the enclosure.

3.3.11 Design Factor (DF). A fraction of the agent minimum design quantity (MDQ) added thereto deemed appropriate due to a specific feature of the protection application or design of the suppression system.

3.3.12 Engineered System. A system requiring individual calculation and design to determine the flow rates, nozzle pressures, pipe size, area or volume protected by each nozzle, quantity of agent, and the number and types of nozzles and their placement in a specific system.

3.3.13 Fill Density. Mass of agent per unit of container volume (the customary units are lb/ft³ or kg/m³).

3.3.14 Final Design Quantity (FDQ). The quantity of agent determined from the agent minimum design quantity as adjusted to account for design factors and pressure adjustment.

3.3.15* Halocarbon Agent. An agent that contains as primary components one or more organic compounds containing one or more of the elements fluorine, chlorine, bromine, or iodine.

3.3.16 Inert Gas Agent. An agent that contains as primary components one or more of the gases helium, neon, argon, or nitrogen. Inert gas agents that are blends of gases can also contain carbon dioxide as a secondary component.

N 3.3.17 Inspection. A visual examination of a system or portion thereof to verify that it appears to be in operating condition and is free of physical damage.

3.3.18 Local Application System. A system consisting of a supply of extinguishing agent arranged to discharge directly on the burning material. [12, 2018]

3.3.19 Lockout Valve. A manually operated valve in the discharge pipe between the nozzles and the agent supply that can be locked in the closed position to prevent flow of agent to the protected area.

3.3.20 Lowest Observable Adverse Effect Level (LOAEL). The lowest concentration at which an adverse physiological or toxicological effect has been observed.

3.3.21 Machinery Space. A space containing the main and auxiliary propulsion machinery.

N 3.3.22 Maintenance. Work performed to ensure that the equipment operates as directed by the manufacturer.

3.3.23 Marine Systems. Systems installed on ships, barges, offshore platforms, motorboats, and pleasure craft.

3.3.24 Minimum Design Quantity (MDQ). The quantity of agent required to achieve the minimum design concentration as calculated using the method in 5.5.1 or 5.5.2, as appropriate.

3.3.25 Minimum Design Temperature. The minimum anticipated temperature within the protected enclosure.

3.3.26 No Observed Adverse Effect Level (NOAEL). The highest concentration at which no adverse toxicological or physiological effect has been observed.

3.3.27* Normally Occupied Enclosure or Space. An enclosure or space where one or more persons are present under normal conditions.

3.3.28 Occupiable Enclosure or Space. An enclosure or space that has dimensions and physical characteristics such that it could be entered by a person.

3.3.29 Pre-Engineered System. A system having predetermined flow rates, nozzle pressures, and quantities of agent. These systems have the specific pipe size, maximum and minimum pipe lengths, flexible hose specifications, number of fittings, and number and types of nozzles prescribed by a testing laboratory. The hazards protected by these systems are specifically limited as to type and size by a testing laboratory based upon actual fire tests. Limitations on hazards that can be protected by these systems are contained in the manufacturer's installation manual, which is referenced as part of the listing.

3.3.30 Pump Room. A space that contains mechanical equipment for handling, pumping, or transferring flammable or combustible liquids as a fuel.

3.3.31 Recovered Agent. Agent that has been removed from a system and kept for future use or until it is destroyed, without necessarily testing or processing it in any way.

3.3.32 Recycled Agent. Agent that has been recovered, tested, and processed as necessary and found to be in compliance with the quality requirement of 4.1.2.

3.3.33 Safety Factor (SF). A multiplier of the agent flame extinguishing or inerting concentration to determine the agent minimum design concentration.

3.3.34 Sea Level Equivalent of Agent. The agent concentration (volume percent) at sea level for which the partial pressure of agent matches the ambient partial pressure of agent at a given altitude.

3.3.35 Sea Level Equivalent of Oxygen. The oxygen concentration (volume percent) at sea level for which the partial pressure of oxygen matches the ambient partial pressure of oxygen at a given altitude.

N 3.3.36 Service. Performance of maintenance, recharge, or testing.

3.3.37 Superpressurization. The addition of gas to a fire extinguishing agent container to achieve a specified pressure therein.

3.3.38 Total Flooding. The act and manner of discharging an agent for the purpose of achieving a specified minimum agent concentration throughout a hazard volume.

3.3.39 Total Flooding System. A system consisting of an agent supply and distribution network designed to achieve a total flooding condition in a hazard volume.

Chapter 4 Components

4.1 Agent Supply.

4.1.1 Quantity.

4.1.1.1 Primary Agent Supply. The quantity of agent in the system primary agent supply shall be at least sufficient for the largest single hazard to be protected or group of hazards to be protected simultaneously.

4.1.1.2* Reserve Agent Supply. Where required, a reserve agent supply shall consist of as many multiples of the primary agent supply as the authority having jurisdiction considers necessary.

4.1.1.3 Uninterrupted Protection. Where uninterrupted protection is required, both the primary and the reserve agent supplies shall be permanently connected to the distribution piping and arranged for easy changeover.

4.1.2* Quality. Agent, including recycled agent, shall meet the standards of quality given in Table 4.1.2(a) through Table 4.1.2(d). Each batch of agent, both recycled and newly manufactured, shall be tested and certified to the specifications given in the tables. Agent blends shall remain homogeneous in storage and use within the listed temperature range and conditions of service that they will encounter.

Table 4.1.2(a) Halogenated Agent Quality Requirements

Property	Specification
Agent purity, mole %, minimum	99.0
Acidity, ppm (by weight HCl equivalent), maximum	3.0
Water content, weight %, maximum	0.001
Nonvolatile residues, g/100 ml maximum	0.05

Table 4.1.2(b) Inert Gas Agent Quality Requirements

Composition	Gas	IG-01	IG-100	IG-541	IG-55
Composition, % by volume	N ₂	Minimum	99.9%	52% ± 4%	50% ± 5%
	Ar	Minimum	99.9%	40% ± 4%	50% ± 5%
	CO ₂			8% + 1% - 0.0%	
Water content, % by weight		Maximum	Maximum	Maximum	Maximum
		0.005%	0.005%	0.005%	0.005%

Table 4.1.2(c) HCFC Blend A Quality Requirements

Component	Amount (weight %)
HCFC-22	82% ± 0.8%
HCFC-124	9.50% ± 0.9%
HCFC-123	4.75% ± 0.5%
Isopropenyl-1-methylcyclohexene	3.75% ± 0.5%

Table 4.1.2(d) HFC Blend B Quality Requirements

Component	Amount (weight %)
HFC-134a	86% ± 5%
HFC-125	9% ± 3%
CO ₂	5% ± 2%

4.1.3 Storage Container Arrangement.

4.1.3.1 Storage containers and accessories shall be located and arranged so that inspection, testing, recharging, and other maintenance activities are facilitated and interruption of protection is held to a minimum.

4.1.3.2* Storage containers shall be permitted to be located within or outside the hazard or hazards they protect.

4.1.3.3 Agent storage containers shall not be located where they can be rendered inoperable or unreliable due to mechanical damage, exposure to chemicals or harsh weather conditions, or any other foreseeable cause. Where container exposure to such conditions is unavoidable, suitable enclosures or protective measures shall be employed.

4.1.3.4 Storage containers shall be installed and secured according to the manufacturer's listed installation manual and

in a manner that provides for convenient individual servicing or content weighing.

4.1.3.5 Where storage containers are connected to a manifold, automatic means, such as a check valve, shall be provided to prevent agent loss and to ensure personnel safety if the system is operated when any containers are removed for maintenance.

4.1.4 Agent Storage Containers.

4.1.4.1* **Storage Containers.** Agent shall be stored in containers designed to hold that specific agent at ambient temperatures. Containers shall be charged to a fill density or superpressurization level within the range specified in the manufacturer's listed manual.

4.1.4.2* Each agent container shall have a permanent nameplate or other permanent marking that indicates the following:

- (1) For halocarbon agent containers, the agent, tare and gross weights, and superpressurization level (where applicable) of the container
- (2) For inert gas agent containers, the agent, pressurization level of the container, and nominal agent volume

4.1.4.3 The containers used in these systems shall be designed to meet the requirements of the U.S. Department of Transportation or the Canadian Transport Commission, if used as shipping containers. If not shipping containers, they shall be designed, fabricated, inspected, certified, and stamped in accordance with Section VIII of the ASME *Boiler and Pressure Vessel Code*; independent inspection and certification are recommended. The design pressure shall be suitable for the maximum pressure developed at 130°F (55°C) or at the maximum controlled temperature limit.

4.1.4.4 A means shall be provided to determine the pressure in containers of inert gas agents, superpressurized liquid agents, and superpressurized liquefied compressed gas agents.

4.1.4.5 The containers connected to a manifold shall meet the following criteria:

- (1) For halocarbon clean agents in a multiple container system, all containers supplying the same manifold outlet for distribution of the same agent shall be interchangeable and of one select size and charge.
- (2)* Inert gas agents shall be permitted to utilize multiple storage container sizes connected to a common manifold.

4.1.4.6* The temperature at which agent containers are stored shall be within the manufacturer's listed limits.

4.2 Distribution.

4.2.1* Pipe.

4.2.1.1* Pipe shall be of material having physical and chemical characteristics such that its integrity under stress can be predicted with reliability. Special corrosion-resistant materials or coatings shall be required in severely corrosive atmospheres. The thickness of the piping shall be calculated in accordance with ASME B31.1. The internal pressure used for this calculation shall not be less than the greater of the following values:

- (1) The normal charging pressure in the agent container at 70°F (21°C)
- (2) Eighty percent of the maximum pressure in the agent container at a maximum storage temperature of not less than 130°F (55°C), using the equipment manufacturer's maximum allowable fill density, if applicable

(3) For inert gas clean agents, the pressure for this calculation shall be as specified in 4.2.1.1.1 and 4.2.1.1.2

4.2.1.1.1 In no case shall the value used for the minimum pipe design pressure be less than that specified in Table 4.2.1.1.1(a) and Table 4.2.1.1.1(b) for the conditions shown. For inert gas clean agents that employ the use of a pressure-reducing device, Table 4.2.1.1.1(a) shall be used for piping upstream of the pressure reducer, and 4.2.1.1.2 shall be used to determine minimum pipe design pressure for piping downstream of the pressure reducer. The pressure-reducing device shall be readily identifiable. For halocarbon clean agents, Table 4.2.1.1.1(b) shall be used. If different fill densities, pressurization levels, or higher storage temperatures from those shown in Table 4.2.1.1.1(a) or Table 4.2.1.1.1(b) are approved for a given system, the minimum design pressure for the piping shall be adjusted to the maximum pressure in the agent container at maximum temperature, using the basic design criteria specified in 4.2.1.1(1) and 4.2.1.1(2).

4.2.1.1.2 For systems that employ the use of a pressure-reducing device, the minimum design pressure for piping downstream of the pressure-reducing device shall be determined from the maximum anticipated pressure in the downstream piping as predicted by system flow calculations.

4.2.1.1.3 Piping for pre-engineered systems shall be designed in accordance with the limitations of the manufacturer's listed installation manual.

4.2.1.2 Other than as allowed in 4.2.1.4, cast-iron pipe, steel pipe conforming to ASTM A120, or nonmetallic pipe shall not be used.

4.2.1.3 Stenciled pipe identification shall not be painted over, concealed, or removed prior to approval by the authority having jurisdiction.

4.2.1.4 Where used, flexible pipe, flexible nonmetallic pipe, tubing, or hoses, including connections, shall be of approved materials and pressure ratings.

4.2.1.5 Each pipe section shall be cleaned internally after preparation and before assembly by means of swabbing, utiliz-

ing a suitable nonflammable cleaner. The pipe network shall be free of particulate matter and oil residue before installation of nozzles or discharge devices.

N 4.2.1.6 Dirt Trap. A dirt trap consisting of a tee with a capped nipple, at least 2 in. (50 mm) long, shall be installed at the end of each pipe run.

4.2.1.7* In sections where valve arrangements introduce sections of closed piping, such sections shall be equipped with pressure relief devices, or the valves shall be designed to prevent entrapment of liquid. In systems using pressure-operated container valves, means shall be provided to vent any container leakage that could build up pressure in the pilot system and cause unwanted opening of the container valve. The means of pressure venting shall be arranged so as not to prevent reliable operation of the container valve.

4.2.1.8 All pressure relief devices shall be designed and located so that the discharge from the device will not injure personnel or pose a hazard.

4.2.2 Pipe Connections.

N 4.2.2.1 Pipe joints other than threaded, welded, brazed, flared, compression, or flanged type shall be listed or approved.

N 4.2.2.2* Fittings shall have a minimum rated working pressure equal to or greater than the minimum design working pressure specified in 4.2.1.1, for the clean agent being used, or as otherwise listed or approved.

N 4.2.2.3 For systems that employ the use of a pressure-reducing device in the distribution piping, the fittings downstream of the device shall have a minimum rated working pressure equal to or greater than the maximum anticipated pressure in the downstream piping.

4.2.2.4 Cast-iron fittings shall not be used.

4.2.2.5 Class 150 fittings shall not be used.

Δ Table 4.2.1.1.1(a) Minimum Design Working Pressure for Inert Gas Clean Agent System Piping

Agent	Agent Container Gauge Pressure at 70°F (21°C)		Agent Container Gauge Pressure at 130°F (55°C)		Minimum Design Pressure of Piping Upstream of Pressure Reducer	
	psi	kPa	psi	kPa	psi	kPa
IG-01	2370	16,341	2650	18,271	2370	16,341
	2964	20,436	3304	22,781	2964	20,436
	4510	31,097	5402	37,244	4510	31,097
IG-541	2175	14,997	2575	17,755	2175	14,997
	2900	19,996	3433	23,671	2900	19,996
	4351	30,000	5150	35,500	4351	30,000
IG-55	2175	15,000	2541	17,600	2175	15,000
	2900	20,000	3434	23,700	2900	20,000
	4350	30,000	5222	36,100	4350	30,000
IG-100	2404	16,575	2799	19,299	2404	16,575
	3236	22,312	3773	26,015	3236	22,312
	4061	28,000	4754	32,778	4061	28,000

Shaded text = Revisions. Δ = Text deletions and figure/table revisions. • = Section deletions. N = New material.

Table 4.2.1.1.1(b) Minimum Design Working Pressure for Halocarbon Clean Agent System Piping

Agent	Agent Container Maximum Fill Density		Agent Container Charging Pressure at 70°F (21°C)		Agent Container Pressure at 130°F (55°C)		Minimum Piping Design Pressure	
	lb/ft ³	kg/m ³	psi	bar	psi	bar	psi	bar
HFC-227ea	79	1265	44*	3	135	9	416	29
	75	1201	150	10	249	17	200	14
	72	1153	360	25	520	36	416	29
	72	1153	600	41	1025	71	820	57
HCFC Blend A	56.2	900	600	41	850	59	680	47
	56.2	900	360	25	540	37	432	30
HFC 23	54	865	608.9†	42	2182	150	1746	120
	48	769	608.9†	42	1713	118	1371	95
	45	721	608.9†	42	1560	108	1248	86
	40	641	608.9†	42	1382	95	1106	76
	35	561	608.9†	42	1258	87	1007	69
	30	481	608.9†	42	1158	80	927	64
HCFC-124	74	1185	240	17	354	24	283	20
HCFC-124	74	1185	360	25	580	40	464	32
HFC-125	54	865	360	25	615	42	492	34
HFC 125	56	897	600	41	1045	72	836	58
HFC-236fa	74	1185	240	17	360	25	280	19
HFC-236fa	75	1201	360	25	600	41	480	33
HFC-236fa	74	1185	600	41	1100	76	880	61
HFC Blend B	58	929	360	25	586	40	469	32
	58	929	600	41	888	61	710	50
FK-5-1-12	90	1442	150	10	175	12	150	10
	90	1442	195	13	225	16	195	13
	90	1442	360	25	413	28	360	25
	75	1201	500	34	575	40	500	34
	90	1442	610	42	700	48	610	42

*Nitrogen delivered to agent cylinder through a flow restrictor upon system actuation. Nitrogen supply cylinder pressure is 1800 psi (124 bar) at 70°F (21°C).

†Not superpressurized with nitrogen.

4.2.2.6 All threads used in joints and fittings shall conform to ASME B1.20.1, *Standard on Pipe Threads, General Purpose*, or ISO 7-1, *Pipe Threads Where Pressure-Tight Joints Are Made on the Threads — Part 1: Dimensions, Tolerances and Designation*. Joint compound, tape, or thread lubricant shall be applied only to the male threads of the joint.

4.2.2.7 Welding and brazing alloys shall have a melting point above 1000°F (538°C).

4.2.2.8 Welding shall be performed in accordance with Section IX, “Qualification Standard for Welding and Brazing Procedures, Welders, Brazers and Welding and Brazing Operators,” of the ASME *Boiler and Pressure Vessel Code*.

4.2.2.9 Where copper, stainless steel, or other suitable tubing is jointed with compression-type fittings, the manufacturer’s pressure and temperature ratings of the fitting shall not be exceeded.

4.2.2.10 Where grooved fittings are used to join pipe, the manufacturer’s pressure and temperature ratings of the fitting shall not be exceeded.

4.2.3* Pipe Hangers and Supports. Pipe hangers and supports shall be designed and installed in accordance with recognized industry practices and manufacturer’s instructions.

4.2.3.1 All pipe hangers and supports shall be attached directly to a rigid fixed structure.

4.2.3.2 All hangers and components shall be steel.

4.2.3.3 Ordinary cast-iron hangers/supports, conduit clamps, or “C” clamps shall not be used.

4.2.3.4 All pipe supports shall be designed and installed to prevent lateral movement of supported pipe during system discharge while permitting longitudinal movement to accommodate expansion and contraction caused by temperature changes.

4.2.3.4.1 Rigid hangers shall be installed wherever a change in elevation or direction occurs.

4.2.3.4.2 Nozzles shall be supported so as to prevent movement of the nozzle during discharge.

4.2.3.5 Where seismic bracing is required, bracing shall be in accordance with local codes and the authority having jurisdiction.

4.2.4 Valves.

4.2.4.1 All valves shall be listed or approved for the intended use.

4.2.4.2 For flanged valves, the class and style of flanges required to match the valve's flanged connection shall be used.

4.2.4.3* All gaskets, O-rings, sealants, and other valve components shall be constructed of materials that are compatible with the agent. Valves shall be protected against mechanical, chemical, or other damage.

4.2.4.4 Special corrosion-resistant materials or coatings shall be used in severely corrosive atmospheres.

4.2.4.5 Where directional valves are used for multihazard protection, the directional valves shall be listed or approved for use with the installed suppression system.

4.2.4.6 Where directional valves are used for multihazard protection, the control equipment shall be specifically listed for the number, type, and operation of those valves.

4.2.5 Discharge Nozzles.

4.2.5.1 Discharge nozzles shall be listed for the intended use. Listing criteria shall include flow characteristics, area coverage, height limits, and minimum pressures. Discharge orifices and discharge orifice plates and inserts shall be of a material that is corrosion resistant to the agent used and the atmosphere in the intended application.

4.2.5.2 Special corrosion-resistant materials or coatings shall be required in severely corrosive atmospheres.

4.2.5.3 Discharge nozzles shall be permanently marked to identify the manufacturer as well as the type and size of the orifice.

4.2.5.4 Where clogging by external foreign materials is likely, discharge nozzles shall be provided with frangible discs, blow-off caps, or other suitable devices. These devices shall provide an unobstructed opening upon system operation and shall be located so they will not injure personnel.

4.2.5.5* Nozzles shall be installed so as to be free of obstructions that could interfere with the proper distribution of the discharged agent in accordance with the manufacturer's installation and maintenance manual.

4.3 Detection, Actuation, Alarm, and Control Systems.

4.3.1 General.

4.3.1.1* Detection, actuation, alarm, and control systems shall be installed, tested, and maintained in accordance with appropriate NFPA protective signaling systems standards. (See *NFPA 70 and NFPA 72. In Canada refer to CAN/ULC S524-14 and CAN/ULC S529-16.*)

N 4.3.1.1.1 The clean agent suppression system or group of systems shall be controlled by a listed clean agent releasing control panel(s) that is listed for monitoring the associated initiating devices, meets the listed compatibility requirements per 4.3.4.1 for actuation of the associated suppression system releasing device(s), and controls the associated suppression system notification appliances.

N 4.3.1.1.2* A protected premises building fire alarm system shall be permitted to serve as a clean agent suppression system releasing control panel only if it is listed for release with the specific clean agent suppression system's releasing device, per 4.3.4.1.

N 4.3.1.1.3 If the clean agent suppression system releasing control panel is located in a protected premises having a separate building fire alarm system, it shall be monitored by the building fire alarm system for alarm, supervisory, and trouble signals.

N 4.3.1.1.4 The clean agent suppression system releasing control panel shall not be dependent upon or affected by the operation or failure of the protected premises building fire alarm panel.

4.3.1.2 Automatic detection and automatic actuation shall be used.

4.3.1.2.1 Manual-only actuation shall be permitted if acceptable to the authority having jurisdiction.

Δ 4.3.1.3* Initiating and releasing circuit wiring shall be installed in raceways.

N 4.3.1.3.1 Other than as permitted in 4.3.1.3.2, alternating current (ac) and direct current (dc) wiring shall not be combined in a common conduit or raceway.

4.3.1.3.2 It shall be permitted to combine ac and dc wiring in a common conduit or raceway where shielded and grounded.

4.3.2 Automatic Detection.

4.3.2.1* Automatic detection shall be by any listed method or device capable of detecting and indicating heat, flame, smoke, combustible vapors, or an abnormal condition in the hazard, such as process trouble, that is likely to produce fire.

4.3.2.2 Adequate and reliable primary and 24-hour minimum standby sources of energy shall be used to provide for operation of the detection, signaling, control, and actuation requirements of the system.

4.3.2.3 Where a new agent system is being installed in a space that has an existing detection system, an analysis shall be made of the detection devices to ensure that the detection system is in good operating condition and will respond promptly to a fire situation. This analysis shall be done to assist in limiting the decomposition products from a suppression event.

4.3.3 Operating Devices.

4.3.3.1 Operating devices shall include agent-releasing devices or valves, discharge controls, and shutdown equipment necessary for successful performance of the system.

4.3.3.2 Operation shall be by listed mechanical, electrical, or pneumatic means. An adequate and reliable source of energy shall be used.

4.3.3.3 All devices shall be designed for the service they will encounter and shall not readily be rendered inoperative or susceptible to accidental operation. Devices normally shall be designed to function properly from -20°F to 130°F (-29°C to 54°C) or marked to indicate temperature limitations.

4.3.3.4 All devices shall be located, installed, or suitably protected so that they are not subject to mechanical, chemical, or other damage that would render them inoperative.

4.3.3.5 A means of manual release of the system shall be provided. Manual release shall be accomplished by a mechanical manual release or by an electrical manual release when the control equipment monitors the battery voltage level of the standby battery supply and provides a low-battery signal. The

release shall cause simultaneous operation of automatically operated valves controlling agent release and distribution.

4.3.3.5.1* A discharge pressure switch shall be required where mechanical system actuation is possible.

4.3.3.5.2 The discharge pressure switch shall provide an alarm-initiating signal to the releasing panel.

4.3.3.5.3 A means of manual release shall not be required for automatic systems when the hazard being protected is unoccupiable and the hazard is in a remote location where personnel are not normally present.

4.3.3.6 The normal manual control(s) for actuation shall be located for easy accessibility at all times, including at the time of a fire.

4.3.3.6.1 The manual control(s) shall be of distinct appearance and clearly recognizable for the purpose intended.

4.3.3.6.2 Operation of any manual control shall cause the complete system to operate as designed.

4.3.3.7 Manual controls shall not require a pull of more than 40 lb (178 N) nor a movement of more than 14 in. (356 mm) to secure operation. At least one manual control for activation shall be located not more than 4 ft (1.2 m) above the floor.

4.3.3.8 Where gas pressure from the system or pilot containers is used as a means for releasing the remaining containers, the supply and discharge rate shall be designed for releasing all the remaining containers.

4.3.3.9 All devices for shutting down supplementary equipment shall be considered integral parts of the system and shall function with the system operation.

4.3.3.10 All manual operating devices shall be identified as to the hazard they protect.

4.3.4 Control Equipment.

4.3.4.1 The control equipment shall be specifically listed for the number and type of actuating devices utilized, and their compatibility shall have been listed.

4.3.4.2* Removal of an electric actuator from the agent storage container discharge valve that it controls shall result in an audible and visual indication of system impairment at the system releasing control panel.

4.3.4.2.1 Paragraph 4.3.4.2 shall become effective January 1, 2016.

4.3.4.2.2 Paragraph 4.3.4.2 shall not apply to systems covered under Chapter 9 of this standard with the exception of those systems included under Section 9.6.

4.3.4.3 Removal of an electric actuator from the selector valve it controls shall result in an audible and visual indication of system impairment at the system releasing control panel.

4.3.4.3.1 Paragraph 4.3.4.3 shall become effective January 1, 2016.

4.3.4.3.2 Paragraph 4.3.4.3 shall not apply to systems covered under Chapter 9 of this standard with the exception of those systems included under Section 9.6.

4.3.4.4 The control equipment shall supervise the actuating devices and associated wiring and, as required, cause actuation.

4.3.4.5 Removal of the primary agent container actuating device from the discharge valve and/or selector valve shall cause a trouble or supervisory signal at the releasing control unit.

4.3.4.6 Where pneumatic control equipment is used, the lines shall be protected against crimping and mechanical damage. Where installations could be exposed to conditions that could lead to loss of integrity of the pneumatic lines, special precautions shall be taken to ensure that no loss of integrity will occur. The control equipment shall be specifically listed for the number and type of actuating devices utilized, and their compatibility shall have been listed.

4.3.5 Operating Alarms and Indicators.

4.3.5.1 Alarms or indicators or both shall be used to indicate the operation of the system, hazards to personnel, or failure of any supervised device. The type (audible, visual, or olfactory), number, and location of the devices shall be such that their purpose is satisfactorily accomplished. The extent and type of alarms or indicator equipment or both shall be approved.

4.3.5.2 Audible and visual pre-discharge alarms shall be provided within the protected area of occupiable spaces to give positive warning of impending discharge. The operation of the warning devices shall be continued after agent discharge until positive action has been taken to acknowledge the alarm and to proceed with appropriate action.

4.3.5.3* Abort switches, where provided, shall be located within the protected area and shall be located near the means of egress for the area. The abort switch shall be of a type that requires constant manual pressure to cause abort. In all cases, the normal manual control and the manual emergency control shall override the abort function. Operation of the abort function shall result in both audible and distinct visual indication of system impairment. The abort switch shall be clearly recognizable for the purpose intended.

4.3.5.4 Alarms indicating failure of supervised devices or equipment shall give prompt and positive indication of any failure and shall be distinctive from alarms indicating operation or hazardous conditions.

4.3.5.5 Warning and instruction signs at entrances to and inside protected areas shall be provided.

4.3.5.5.1 Warning and safety instruction signs shall be located such that they will be readily visible to personnel in the area where the clean agent design concentration exceeds that approved for use in normally occupied spaces. The safety sign format and color and the letter style of the signal words shall be in accordance with ANSI Z535.2.

4.3.5.5.2 Warning and safety instruction signs shall be located outside each entrance to clean agent cylinder storage rooms. The safety sign format and color and the letter style of the signal words shall be in accordance with ANSI Z535.2.

4.3.5.6 Time Delays.

4.3.5.6.1* For clean agent extinguishing systems, a pre-discharge alarm and time delay, sufficient to allow personnel evacuation prior to discharge, shall be provided. For hazard areas subject to fast growth fires, where the provision of a time delay would seriously increase the threat to life and property, a time delay shall be permitted to be eliminated.

4.3.5.6.2 Time delays shall be used only for personnel evacuation or to prepare the hazard area for discharge.

4.3.5.6.3 Time delays shall not be used as a means of confirming operation of a detection device before automatic actuation occurs.

4.3.6* Unwanted System Operation.

4.3.6.1 To avoid unwanted discharge of an electrically actuated clean agent system, a supervised disconnect switch shall be provided.

4.3.6.2 The disconnect switch shall interrupt the releasing circuit to the suppression system.

4.3.6.3 The disconnect switch shall cause a supervisory signal at the releasing control unit.

4.3.6.4 The disconnect switch shall be secured against unauthorized use by one of the following methods:

- (1) Locate inside a lockable releasing control panel
- (2) Locate inside a lockable enclosure
- (3) Require a key for activation of the switch

4.3.6.5 When the disconnect switch requires a key for activation, the access key shall not be removable while disconnected so the suppression system can be quickly returned to the operational condition in the event of a fire.

4.3.6.6 Suppression system disconnect achieved via software programming shall not be acceptable for use in lieu of a physical disconnect switch.

4.3.6.7 The disconnect switch shall be listed.

Chapter 5 System Design

5.1 Specifications, Plans, and Approvals.

5.1.1 Specifications. Specifications for total flooding and local application clean agent fire extinguishing systems shall be prepared under the supervision of a person fully experienced and qualified in the design of such systems and with the advice of the authority having jurisdiction. The specifications shall include all pertinent items necessary for the proper design of the system, such as the designation of the authority having jurisdiction, variances from the standard to be permitted by the authority having jurisdiction, design criteria, system sequence of operations, the type and extent of the approval testing to be performed after installation of the system, and owner training requirements.

5.1.2 Working Plans.

5.1.2.1 Working plans and calculations shall be submitted for approval to the authority having jurisdiction before system installation or remodeling begins. These documents shall be prepared only by persons fully experienced and qualified in the design of total flooding and local application clean agent fire extinguishing systems. Deviation from these documents shall require permission of the authority having jurisdiction.

5.1.2.2 Working plans shall be drawn to an indicated scale and shall show the following items that pertain to the design of the system:

- (1) Name of owner and occupant
- (2) Location, including street address

- (3) Point of compass and symbol legend
- (4) Location and construction of protected enclosure walls and partitions
- (5) Location of fire walls
- (6) Enclosure cross section, shown as a full-height or schematic diagram, including location and construction of building floor-ceiling assemblies above and below, raised access floor, and suspended ceiling
- (7) Agent being used
- (8) Agent concentration at the lowest temperature and the highest temperature for which the enclosure is protected
- (9) Description of occupancies and hazards being protected, designating whether the enclosure is normally occupied
- (10) For an enclosure protected by a clean agent fire extinguishing system, an estimate of the maximum positive pressure and the maximum negative pressure, relative to ambient pressure, expected to be developed upon the discharge of agent
- (11) Description of exposures surrounding the enclosure
- (12) Description of the agent storage containers used, including internal volume, storage pressure, and nominal capacity expressed in units of agent mass or volume at standard conditions of temperature and pressure
- (13) Description of nozzle(s) used, including size, orifice port configuration, and equivalent orifice area
- (14) Description of pipe and fittings used, including material specifications, grade, and pressure rating
- (15) Description of wire or cable used, including classification, gauge [American Wire Gauge (AWG)], shielding, number of strands in conductor, conductor material, and color coding schedule; segregation requirements of various system conductors; and required method of making wire terminations
- (16) Description of the method of detector mounting
- (17) Equipment schedule or bill of materials for each piece of equipment or device showing device name, manufacturer, model or part number, quantity, and description
- (18) Plan view of protected area showing enclosure partitions (full and partial height); agent distribution system, including agent storage containers, piping, and nozzles; type of pipe hangers and rigid pipe supports; detection, alarm, and control system, including all devices and schematic of wiring interconnection between them; end-of-line device locations; location of controlled devices such as dampers and shutters; and location of instructional signage
- (19) Isometric view of agent distribution system showing the length and diameter of each pipe segment; node reference numbers relating to the flow calculations; fittings, including reducers, strainers, and orientation of tees; and nozzles, including size, orifice port configuration, flow rate, and equivalent orifice area
- (20) Scale drawing showing the layout of the annunciator panel graphics if required by the authority having jurisdiction
- (21) Details of each unique rigid pipe support configuration showing method of securement to the pipe and to the building structure
- (22) Details of the method of container securement showing method of securement to the container and to the building structure
- (23) Complete step-by-step description of the system sequence of operations, including functioning of abort

and maintenance switches, delay timers, and emergency power shutdown

- (24) Point-to-point wiring schematic diagrams showing all circuit connections to the system control panel and graphic annunciator panel
- (25) Point-to-point wiring schematic diagrams showing all circuit connections to external or add-on relays
- (26) Complete calculations to determine enclosure volume, quantity of clean agent, and size of backup batteries; method used to determine number and location of audible and visual indicating devices; and number and location of detectors
- (27) Details of any special features
- (28)* Pressure relief vent area, or equivalent leakage area, for the protected enclosure to prevent development, during system discharge, of a pressure difference across the enclosure boundaries that exceeds a specified enclosure pressure limit

5.1.2.3 The detail on the system shall include information and calculations on the quantity of agent; container storage pressure; internal volume of the container; the location, type, and flow rate of each nozzle, including equivalent orifice area; the location, size, and equivalent lengths of pipe, fittings, and hose; and the location and size of the storage facility. Pipe size reduction and orientation of tees shall be clearly indicated. Information shall be submitted pertaining to the location and function of the detection devices, operating devices, auxiliary equipment, and electrical circuitry, if used. Apparatus and devices used shall be identified. Any special features shall be adequately explained.

5.1.2.3.1 Pre-engineered systems shall not be required to specify an internal volume of the container, nozzle flow rates, equivalent lengths of pipe, fittings, and hose, or flow calculations, when used within their listed limitations. The information required by the listed system design manual, however, shall be made available to the authority having jurisdiction for verification that the system is within its listed limitations.

5.1.2.4 An “as-built” instruction and maintenance manual that includes a full sequence of operations and a full set of drawings and calculations shall be maintained on site.

5.1.2.5 Flow Calculations.

5.1.2.5.1 Flow calculations along with the working plans shall be submitted to the authority having jurisdiction for approval. The version of the flow calculation program shall be identified on the computer calculation printout.

5.1.2.5.2 Where field conditions necessitate any material change from approved plans, the change shall be submitted for approval.

5.1.2.5.3 When such material changes from approved plans are made, corrected “as-installed” plans shall be provided.

5.1.3 Approval of Plans.

5.1.3.1 Plans and calculations shall be approved prior to installation.

5.1.3.2 Where field conditions necessitate any significant change from approved plans, the change shall be approved prior to implementation.

5.1.3.3 When such significant changes from approved plans are made, the working plans shall be updated to accurately represent the system as installed.

5.2* System Flow Calculations.

5.2.1* System flow calculations shall be performed using a calculation method listed or approved by the authority having jurisdiction. The system design shall be within the manufacturer’s listed limitations.

5.2.1.1 Designs involving pre-engineered systems shall not be required to be provided with flow calculations in accordance with 5.1.2.5 where used within their listed limitations.

5.2.2 Valves and fittings shall be rated for equivalent length in terms of pipe or tubing sizes with which they will be used. The equivalent length of the container valve shall be listed and shall include siphon tube, valve, discharge head, and flexible connector.

5.2.3 Piping lengths and orientation of fittings and nozzles shall be in accordance with the manufacturer’s listed limitations.

5.2.4 If the final installation varies from the prepared drawings and calculations, new drawings and calculations representing the “as-built” installation shall be prepared.

5.3* Enclosure.

5.3.1 In the design of a total flooding system, the characteristics of the protected enclosure shall be considered.

5.3.2 The area of unclosable openings in the protected enclosure shall be kept to a minimum.

5.3.3 The authority having jurisdiction shall be permitted to require pressurization/depressurization of the protected enclosure or other tests to ensure performance that meets the requirements of this standard. (*See Annex C.*)

5.3.4 To prevent loss of agent through openings to adjacent hazards or work areas, openings shall be permanently sealed or equipped with automatic closures. Where reasonable confinement of agent is not practicable, protection shall be expanded to include the adjacent connected hazards or work areas, or additional agent shall be introduced into the protected enclosure using an extended discharge configuration.

5.3.5 Where a clean agent total flooding system is being provided for the protection of a room with a raised or sunken floor, the room and raised or sunken floor shall be simultaneously protected.

5.3.5.1* If only the space under the raised floor is to be protected by a total flooding system, an inert gas shall be used to protect that space.

5.3.5.2 Each volume, room, and raised or sunken floor to be protected shall be provided with detectors, piping network, and nozzles.

5.3.6* Other than the ventilation systems identified in 5.3.6.2, forced-air ventilating systems, including self-contained air recirculation systems, shall be shut down or closed automatically where their continued operation would adversely affect the performance of the fire extinguishing system or result in propagation of the fire.

5.3.6.1 If not shut down or closed automatically, the volume of the self-contained recirculating undamped ventilation system ducts and components mounted below the ceiling height of the protected space shall be considered as part of the total hazard volume when determining the quantity of agent.

5.3.6.2 Ventilation systems necessary to ensure safety shall not be required to be shut down upon activation of the fire suppression system. An extended agent discharge shall be provided to maintain the design concentration for the required duration of protection.

5.3.7* The protected enclosure shall have the structural strength and integrity necessary to contain the agent discharge. If the developed pressures present a threat to the structural strength of the enclosure, venting shall be provided to prevent excessive pressures. Designers shall consult the system manufacturer's recommended procedures relative to enclosure venting. [For *pressure relief vent area or equivalent leakage area*, see 5.1.2.2(28).]

5.4 Design Concentration Requirements.

5.4.1 The flame extinguishing or inerting concentrations shall be used in determining the agent design concentration for a particular fuel. For combinations of fuels, the flame extinguishment or inerting value for the fuel requiring the greatest concentration shall be used unless tests are made on the actual mixture.

5.4.2 Flame Extinguishment.

5.4.2.1* The flame extinguishing concentration for Class B fuels shall be determined by the cup burner method described in Annex B.

CAUTION: Under certain conditions, it can be dangerous to extinguish a burning gas jet. As a first measure, the gas supply shall be shut off.

5.4.2.1.1 Measurement equipment used in applying the cup burner method shall be calibrated.

5.4.2.2* The flame extinguishing concentration for Class A fuels shall be determined by test as part of a listing program. As a minimum, the listing program shall conform to ANSI/UL 2127 or ANSI/UL 2166 or equivalent.

5.4.2.3 The minimum design concentration for a Class B fuel hazard shall be the extinguishing concentration, as determined in 5.4.2.1, times a safety factor of 1.3.

5.4.2.4* The minimum design concentration for a Class A surface-fire hazard shall be determined by the greater of the following:

- (1) The extinguishing concentration, as determined in 5.4.2.2, times a safety factor of 1.2
- (2) Equal to the minimum extinguishing concentration for heptane as determined from 5.4.2.1

5.4.2.5 The minimum design concentration for a Class C hazard shall be the extinguishing concentration, as determined in 5.4.2.2, times a safety factor of 1.35.

5.4.2.5.1 The minimum design concentration for spaces containing energized electrical hazards supplied at greater than 480 volts that remain powered during and after discharge shall be determined by testing, as necessary, and a hazard analysis.

5.4.2.6* The minimum design concentration for a smoldering combustion hazard (deep-seated fire hazard) shall be determined by an application-specific test.

5.4.3* Inerting.

5.4.3.1 The inerting concentration shall be determined by test.

5.4.3.2* The inerting concentration shall be used in determining the agent design concentration where conditions for subsequent reflash or explosion exist.

5.4.3.3 The minimum design concentration used to inert the atmosphere of an enclosure where the hazard is a flammable liquid or gas shall be the inerting concentration times a safety factor of 1.1.

5.5 Total Flooding Quantity.

5.5.1* The quantity of halocarbon agent required to achieve the design concentration shall be calculated from the following equation:

[5.5.1]

$$W = \frac{V}{S} \left(\frac{C}{100 - C} \right)$$

where:

W = quantity of clean agent [lb (kg)]

V = net volume of hazard, calculated as the gross volume minus the volume of fixed structures impervious to clean agent vapor [ft³ (m³)]

C = agent design concentration (vol %)

s = specific volume of the superheated agent vapor at 1 atm and the minimum anticipated temperature [°F (°C)] of the protected volume [ft³/lb (m³/kg)]

5.5.1.1 The concentration of halocarbon clean agent that will be developed in the protected enclosure shall be calculated at both the minimum and maximum design temperature using the following equation:

[5.5.1.1]

$$C = 100 \frac{\left(\frac{W \times s}{V} \right)}{\left(\frac{W \times s}{V} \right) + 1}$$

where:

C = agent concentration [vol %]

W = installed quantity of agent [lb (kg)]

s = specific volume of the gaseous agent at the minimum/maximum design temperature of the hazard [ft³/lb (m³/kg)]

V = volume of the as-built enclosure [ft³ (m³)]

5.5.1.2 Agent concentrations calculated based on as-built and as-installed data and the lowest and highest design temperatures of the protected space shall be recorded in accordance with the requirements of 5.1.2.4 and 5.2.4.

5.5.2* The quantity of inert gas agent required to achieve the design concentration shall be calculated using Equation 5.5.2, 5.5.2.1a, or 5.5.2.1b:

Δ

[5.5.2]

$$X = 2.303 \left(\frac{s_0}{s} \right) \log_{10} \left(\frac{100}{100 - C} \right)$$

where:

X = volume of inert gas added at standard conditions of 14.7 psi absolute, 70°F (1.013 bar absolute, 21°C) per volume of hazard space [ft³/ft³ (m³/m³)]

s_0 = specific volume of inert gas agent at 70°F (21°C) and 14.7 psi absolute (1.013 bar absolute)

s = specific volume of inert gas at 14.7 psi absolute and the minimum design temperature [°F (°C)] of the protected volume [ft³/lb (m³/kg)]

C = inert gas design concentration (vol %)

5.5.2.1* An alternative equation for calculating the inert gas clean agent concentrations shall be permitted, as follows:

Δ

[5.5.2.1a]

$$X = 2.303 \left(\frac{530}{460 + t} \right) \log_{10} \left(\frac{100}{100 - C} \right)$$

where:

t = minimum anticipated temperature of the protected volume (°F)

Δ

[5.5.2.1b]

$$X = 2.303 \left(\frac{294}{273 + t} \right) \log_{10} \left(\frac{100}{100 - C} \right)$$

where:

t = minimum anticipated temperature of the protected volume (°C)

5.5.2.2 The design quantity of inert gas agent in mass units shall be calculated as follows:

[5.5.2.2a]

$$W = 2.303 \left(\frac{V}{s} \right) \log_{10} \left(\frac{100}{100 - C} \right)$$

or

[5.5.2.2b]

$$W = \left(\frac{V}{s} \right) \ln \left(\frac{100}{100 - C} \right)$$

where:

W = quantity of inert gas agent [lb (kg)]

V = volume of the hazard [ft³ (m³)]

s = specific volume of the gaseous agent at the temperature of the hazard [ft³/lb (m³/kg)]

C = inert gas agent concentration [vol %]

5.5.2.3 The concentration of an inert gas clean agent that will be developed in the protected enclosure shall be calculated at both the minimum and maximum design temperature, using one of the following equations:

Δ

[5.5.2.3a]

$$C = 100 \frac{10^{\left(\frac{W \cdot s}{2.303 \cdot V} \right)} - 1}{10^{\left(\frac{W \cdot s}{2.303 \cdot V} \right)}}$$

or

Δ

[5.5.2.3b]

$$C = 100 \frac{e^{\left(\frac{W \cdot s}{V} \right)} - 1}{e^{\left(\frac{W \cdot s}{V} \right)}}$$

where:

C = agent concentration [vol %]

W = installed quantity of agent [lb (kg)]

s = specific volume of the gaseous agent at the minimum/maximum design temperature of the hazard [ft³/lb (m³/kg)]

V = volume of the as-built enclosure [ft³ (m³)]

5.5.3* Design Factors. Where special conditions could affect the extinguishing efficiency, the minimum quantity of agent shall be increased through the use of design factors.

5.5.3.1* Tee Design Factor. Other than as identified in 5.5.3.1.3, where a single agent supply is used to protect multiple hazards, a design factor from Table 5.5.3.1 shall be applied.

5.5.3.1.1 For the application of Table 5.5.3.1, the design factor tee count shall be determined for each hazard the system protects, using the following guidelines:

- (1) Starting from the point where the pipe system enters the hazard, the number of tees in the flow path returning to the agent supply shall be included (do not include tees used in a manifold) in the design factor tee count for the hazard.
- (2) Any tee within the hazard that supplies agent to another hazard shall be included in the design factor tee count for the hazard.

Table 5.5.3.1 Design Factors for Piping Tees

Design Factor Tee Count	Halocarbon Design Factor	Inert Gas Design Factor
0–4	0.00	0.00
5	0.01	0.00
6	0.02	0.00
7	0.03	0.00
8	0.04	0.00
9	0.05	0.01
10	0.06	0.01
11	0.07	0.02
12	0.07	0.02
13	0.08	0.03
14	0.09	0.03
15	0.09	0.04
16	0.10	0.04
17	0.11	0.05
18	0.11	0.05
19	0.12	0.06

5.5.3.1.2 The hazard with the greatest design factor tee count shall be used in Table 5.5.3.1 to determine the design factor.

5.5.3.1.3 For systems that pass a discharge test, this design factor shall not apply.

5.5.3.2* Additional Design Factors. The designer shall assign and document additional design factors for each of the following:

- (1) Unclosable openings and their effects on distribution and concentration (*see also 5.8.2*)
- (2) Control of acid gases
- (3) Re-ignition from heated surfaces
- (4) Fuel type, configurations, scenarios not fully accounted for in the extinguishing concentration, enclosure geometry, and obstructions and their effects on distribution

5.5.3.3* Design Factor for Enclosure Pressure. The design quantity of the clean agent shall be adjusted to compensate for ambient pressures that vary more than 11 percent [equivalent to approximately 3000 ft (915 m) of elevation change] from standard sea level pressures [29.92 in. Hg at 70°F (760 mm Hg at 0°C)]. (*See Table 5.5.3.3.*)

5.6* Duration of Protection. A minimum concentration of 85 percent of the adjusted minimum design concentration shall be held at the highest height of protected content within the hazard for a period of 10 minutes or for a time period sufficient to allow for response by trained personnel.

5.6.1* It is important that the adjusted minimum design concentration of agent not only shall be achieved but also shall be maintained for the specified period of time to allow effective emergency action by trained personnel.

5.7 Distribution System.

5.7.1 Rate of Application.

5.7.1.1* Discharge Time.

5.7.1.1.1* For halocarbon agents, the discharge time required to achieve 95 percent of the minimum design concentration for flame extinguishment based on a 20 percent safety factor

shall not exceed 10 seconds or as otherwise required by the authority having jurisdiction.

5.7.1.1.2* For inert gas agents, the discharge time required to achieve 95 percent of the minimum design concentration for flame extinguishment shall not exceed 60 seconds for Class B fuel hazards, 120 seconds for Class A surface-fire hazards or Class C hazards, or as otherwise required by the authority having jurisdiction.

5.7.1.1.3* The discharge time period is defined as the time required to discharge from the nozzles 95 percent of the agent mass [at 70°F (21°C)] necessary to achieve the minimum design concentration based on a 20 percent safety factor for flame extinguishment.

5.7.1.1.4 Flow calculations performed in accordance with Section 5.2 or in accordance with the listed pre-engineered systems instruction manuals shall be used to demonstrate compliance with 5.7.1.1.

5.7.1.1.5 For explosion prevention systems, the discharge time for agents shall ensure that the minimum inerting design concentration is achieved before concentration of flammable vapors reach the flammable range.

5.7.2* Extended Discharge. When an extended discharge is necessary to maintain the design concentration for the specified period of time, additional agent quantities can be applied at a reduced rate. The initial discharge shall be completed within the limits specified in 5.7.1.1. The performance of the extended discharge system shall be confirmed by test.

5.8 Nozzle Choice and Location.

5.8.1 Nozzles shall be of the type listed for the intended purpose and shall be placed within the protected enclosure in compliance with listed limitations with regard to spacing, floor coverage, and alignment.

5.8.2 The type of nozzles selected, their number, and their placement shall be such that the design concentration will be established in all parts of the hazard enclosure and such that the discharge will not unduly splash flammable liquids or create dust clouds that could extend the fire, create an explosion, or otherwise adversely affect the contents or integrity of the enclosure.

▲ Table 5.5.3.3 Atmospheric Correction Factors

Equivalent Altitude		Enclosure Pressure (Absolute)		Atmospheric Correction Factor
ft	km	psi	mm Hg	
-3,000	-0.92	16.25	840	1.11
-2,000	-0.61	15.71	812	1.07
-1,000	-0.30	15.23	787	1.04
0	0.00	14.70	760	1.00
1,000	0.30	14.18	733	0.96
2,000	0.61	13.64	705	0.93
3,000	0.91	13.12	678	0.89
4,000	1.22	12.58	650	0.86
5,000	1.52	12.04	622	0.82
6,000	1.83	11.53	596	0.78
7,000	2.13	11.03	570	0.75
8,000	2.45	10.64	550	0.72
9,000	2.74	10.22	528	0.69
10,000	3.05	9.77	505	0.66

Chapter 6 Local Application Systems

6.1 Description. A local application system shall consist of a fixed supply of clean agent permanently connected to a system of fixed piping with nozzles arranged to discharge directly into the fire.

6.1.1 Uses. Local application systems shall be used for the extinguishment of surface fires in flammable liquids, gases, and shallow solids where the hazard is not enclosed or where the enclosure does not conform to the requirements for total flooding.

6.1.2 General Requirements. Local application systems shall be designed, installed, tested, and maintained in accordance with the applicable requirements of this standard.

6.1.3* Safety Requirements. The safety requirements of Section 1.5 shall apply. During agent discharge, locally high concentrations of the agent will be developed; therefore the

requirements of Section 1.5 shall be followed to prevent exposure of personnel to high concentrations of agent.

6.2 Hazard Specifications.

6.2.1 Extent of Hazard. The hazard shall be so isolated from other hazards or combustibles that fire will not spread outside the protected area.

6.2.1.1 The entire hazard shall be protected.

6.2.1.2 The hazard shall include all areas that are or can become coated by combustible liquids or shallow solid coatings, such as areas subject to spillage, leakage, dripping, splashing, or condensation.

6.2.1.3 The hazard shall also include all associated materials or equipment, such as freshly coated stock, drain boards, hoods, ducts, and so forth, that could extend fire outside or lead fire into the protected area.

6.2.1.4 A series of interexposed hazards shall be permitted to be subdivided into smaller groups or sections with the approval of the authority having jurisdiction.

6.2.1.4.1 Systems for such hazards shall be designed to give immediate independent protection to adjacent groups or sections as needed.

6.2.2 Location of Hazard.

6.2.2.1 The hazard shall be permitted to be indoors, partly sheltered, or completely out of doors.

6.2.2.2 The clean agent discharge shall be such that winds or strong air currents do not impair the protection. It shall be the responsibility of the system designer to show that such conditions have been taken into account in the design of a system.

6.3 Clean Agent Requirements. The quantity of clean agent required for local application systems shall be based on the rate of discharge and the time that the discharge must be maintained to ensure complete extinguishment. The minimum design quantity shall be no less than 1.5 times the minimum quantity required for extinguishment at any selected system discharge rate.

6.4 Nozzles.

6.4.1 Nozzle Selection. The basis for nozzle selection shall be listed performance data that clearly depict the interrelationship of agent quantity, discharge rate, discharge time, area coverage, and the distance of the nozzle from the protected surface.

6.4.1.1* The maximum permitted time to extinguish a fire with a halocarbon agent shall be 10 seconds.

6.4.1.2* The maximum permitted time to extinguish a fire with an inert gas agent shall be 30 seconds.

6.4.1.3* Where flammable liquid fires of appreciable depth [over ¼ in. (6 mm)] are to be protected, a minimum freeboard of 6 in. (152 mm) shall be provided unless otherwise noted in approvals or listings of nozzles.

6.4.2 Nozzle Discharge Rates. The design discharge rate through individual nozzles shall be determined on the basis of location or projection distance in accordance with specific approvals or listings.

6.4.2.1 The system discharge rate shall be the sum of the individual rates of all the nozzles and discharge devices used in the system.

6.4.3 Discharge Time. The minimum design discharge time shall be determined by dividing the design quantity by the design rate.

6.4.3.1 The discharge time shall be increased to compensate for any hazard condition that would require a longer cooling period or for mechanical rundown time associated with ventilation equipment present to prevent re-ignition.

6.4.3.2 Where there is a possibility that metal or other material can become heated above the ignition temperature of the fuel, the effective discharge time shall be increased to allow adequate cooling time.

6.4.3.3* Where the fuel has an auto-ignition point below its boiling point, such as paraffin wax and cooking oils, the effective discharge time shall be increased to permit cooling of the fuel to prevent re-ignition.

6.5 Location and Number of Nozzles.

6.5.1* A sufficient number of nozzles shall be used to cover the entire hazard area on the basis of the unit areas protected by each nozzle.

6.5.2* Local application nozzles shall be located in accordance with spacing and discharge rate limitations stated in nozzle listings.

6.5.3 Linear detection tubing shall be permitted to be used for agent discharge within the limitations of its listing.

6.5.4 Nozzles shall be located so as to protect coated stock or other hazards extending above a protected surface.

6.6* Operation. The system shall be designed for automatic operation except where the authority having jurisdiction permits manual operation.

Chapter 7 Approval of Installations

N 7.1* Safety. Safe procedures shall be observed during installation, servicing, maintenance, testing, handling, and recharging of clean agent systems and agent containers.

N 7.2* General.

N 7.2.1 The completed system shall be reviewed and tested by personnel that have knowledge and experience of the requirements contained in this standard, of the installed equipment, and of the manufacturer's design, installation, and maintenance manual.

N 7.2.2 Only listed equipment and devices shall be used in the systems.

N 7.2.3 System Acceptance Testing.

N 7.2.3.1 The system shall be tested in accordance with the requirements of this standard and the manufacturer's design, installation, and maintenance manual.

N 7.2.3.2 Equipment shall be inspected to verify that it is installed in accordance with the manufacturer's instructions and the system design documents.

- N 7.2.3.3** The actual hazard dimensions shall be checked against those indicated on the system drawings to verify the quantity of agent.
- N 7.2.3.4*** If a discharge test is to be conducted, containers for the agent to be used shall be weighed before and after the discharge test.
- N 7.2.3.5** The weight of agent in the containers shall be verified by weighing or other approved methods.
- N 7.2.3.6** For inert gas clean agents, container pressure shall be recorded before and after the discharge test.
- N 7.2.3.7** When applicable for system operation, fan coastdown and damper closure time shall be verified that they are in accordance with the system design criteria.
- N 7.2.4** When required by project specifications, integrated fire protection and life safety system testing shall be in accordance with NFPA 4.
- N 7.3 Acceptance Test Report.**
- N 7.3.1*** The acceptance testing required by 7.2.3 shall be documented in a test report.
- N 7.3.2** The acceptance test report shall be maintained by the system owner for the life of the system.
- N 7.4 Review of Mechanical Components.**
- N 7.4.1** The piping distribution system shall be inspected to determine that it is in compliance with the design and installation documents.
- N 7.4.2** Nozzles and pipe size shall be in accordance with system drawings.
- N 7.4.3** Means of pipe size reduction and attitudes of tees shall be checked for conformance to the design.
- N 7.4.4** Piping joints, discharge nozzles, and piping supports shall be securely fastened to prevent unwanted vertical or lateral movement during discharge.
- N 7.4.5** Discharge nozzles shall be installed in such a manner that piping cannot become detached during discharge.
- N 7.4.6** During assembly, the piping distribution system shall be inspected internally to detect the possibility of any oil or particulate matter soiling the hazard area or affecting the agent distribution due to a reduction in the effective nozzle orifice area.
- N 7.4.7** The discharge nozzle shall be oriented in accordance with the nozzle listing.
- N 7.4.8** If nozzle deflectors are installed, they shall be positioned per the equipment listing.
- N 7.4.9** The discharge nozzles, piping, and mounting brackets shall be installed in such a manner that they will not potentially cause injury to personnel.
- N 7.4.10** Agent shall not directly impinge on areas where personnel could be found in the normal work area.
- N 7.4.11** Agent shall not directly impinge on any loose objects or shelves, cabinet tops, or similar surfaces where loose objects could be present and become projectiles.
- N 7.4.12** All agent storage containers shall be located in accordance with an approved set of system drawings.
- N 7.4.13** All containers and mounting brackets shall be fastened securely in accordance with the manufacturer's requirements.
- N 7.4.14** The pipe system shall be pressure-tested in a closed circuit using nitrogen or other dry gas.
- N 7.4.14.1** The pipe shall be pressurized to at least 40 psi (276 kPa).
- N 7.4.14.2** After removing the source of pressurizing gas, the pressure in the pipe shall not be less than 80 percent of the test pressure after 10 minutes.
- N 7.4.14.3** The pressure test shall be permitted to be omitted if the total piping contains no more than one change in direction fitting between the storage container and the discharge nozzle and if all piping has been physically checked for tightness.
- N 7.4.15*** A flow test using nitrogen or an inert gas shall be performed on the piping network to verify that flow is continuous.
- N 7.5 Review of Enclosure Integrity.**
- N 7.5.1** It shall be determined that the protected enclosure is in general conformance with the construction documents.
- N 7.5.2** All total flooding systems shall have the enclosure examined and tested to locate and then effectively seal any significant air leaks that could result in a failure of the enclosure to hold the specified agent concentration level for the specified holding period.
- N 7.5.3*** Quantitative results shall be obtained and recorded to indicate that the specified agent concentration for the specified duration of protection is in compliance with Section 5.6, using an approved blower fan unit or other means as approved by the authority having jurisdiction. (*For guidance, see Annex C.*)
- N 7.6 Review of Electrical Components.**
- N 7.6.1** All wiring systems shall be installed in compliance with local codes and the system drawings.
- N 7.6.2** Alternating current (ac) and direct current (dc) wiring shall not be combined in a common conduit or raceway unless shielded and grounded.
- N 7.6.3** All field circuits shall be free of ground faults and short circuits.
- N 7.6.3.1** Where field circuitry is being measured, all electronic components, such as smoke and flame detectors or special electronic equipment for other detectors or their mounting bases, shall be removed and jumpers shall be installed to prevent the possibility of damage within these devices.
- N 7.6.3.2** Components removed in accordance with 7.6.3.1 shall be replaced after measuring.
- N 7.6.4** Power shall be supplied to the control unit from a separate dedicated source that will not be shut down upon system operation.
- N 7.6.5** Adequate and reliable primary and 24-hour minimum standby sources of energy shall be used to provide for operation of the detection, signaling, control, and actuation requirements of the system.

- N 7.6.6*** All auxiliary functions such as alarm-sounding or displaying devices, remote annunciators, air-handling shut-down, and power shutdown shall be checked for operation in accordance with system requirements and design specifications.
- N 7.6.7** Silencing of alarms, if permitted, shall not affect other auxiliary functions.
- N 7.6.8** The detection devices shall be checked for type and location as specified on the system drawings.
- N 7.6.9*** Detectors shall not be located near obstructions or air ventilation and cooling equipment that would affect their response characteristics.
- N 7.6.10*** The design of the detection system must take into consideration the volume of air changes within the protected area.
- N 7.6.11** The detectors shall be installed in accordance with the manufacturer's technical data and the requirements of *NFPA 72*.
- N 7.6.12 Manual Pull Stations.**
- N 7.6.12.1** Manual pull stations shall be securely mounted.
- N 7.6.12.2** The operable part of a manual pull station shall be not less than 42 in. (1.07 m) and not more than 48 in. (1.22 m) from the finished floor.
- N 7.6.12.3** Manual pull stations shall be installed so that they are conspicuous, unobstructed, and accessible.
- N 7.6.12.4*** All manual pull stations shall be identified as to the hazard they protect, the function they perform, and their method of operation.
- N 7.6.12.5** All manual stations used to release agents shall require two separate and distinct actions for operation.
- N 7.6.13 Systems with Main/Reserve Capability.** For systems with a main/reserve capability, the main/reserve switch shall be installed in accordance with the system manufacturer's design, installation, and maintenance manual and the system drawings.
- N 7.6.13.1** For systems with a main/reserve capability, the main/reserve switch shall be installed in accordance with the system manufacturer's design, installation, and maintenance manual and the system drawings.
- N 7.6.13.2** If installed, the main/reserve switch shall be identified.
- N 7.6.14 Systems Using Abort Switches.**
- N 7.6.14.1** Abort switches shall be of the deadman type requiring constant manual pressure.
- N 7.6.14.2** Switches that remain in the abort position when released shall not be used for this purpose.
- N 7.6.14.3** Abort switches shall be installed so that they are readily accessible within the hazard.
- N 7.6.14.4** Abort switches shall be securely mounted.
- N 7.6.14.5** Abort stations shall be installed so they are conspicuous, unobstructed, and accessible.
- N 7.6.14.6** The operable part of an abort switch shall be not less than 42 in. (1.07 m) and not more than 48 in. (1.22 m) from the finished floor.
- N 7.6.14.7** Manual pull stations shall always override abort switches.
- N 7.6.15** The releasing control unit shall be installed in accordance with the system documentation and readily accessible.
- N 7.7 Functional Testing.**
- N 7.7.1 Preliminary Functional Tests.**
- N 7.7.1.1** If the system is connected to an alarm receiving office, the alarm receiving office shall be notified that the fire system test is to be conducted and that an emergency response by the fire department or alarm station personnel is not desired.
- N 7.7.1.2** All personnel in areas that could be affected by the testing at the end user's facility shall be notified that a test is to be conducted.
- N 7.7.1.3*** All personnel in areas that could be affected by the testing at the end user's facility shall be instructed as to events that could occur during testing of the fire extinguishing system.
- N 7.7.1.4*** Each agent storage container release mechanism shall be disabled or replaced with a functional device so that activation of the release circuit will not release agent.
- N 7.7.1.5** Each detector shall be tested for operation.
- N 7.7.1.6** All polarized alarm devices and auxiliary relays shall be checked for polarity in accordance with the manufacturer's instructions.
- N 7.7.1.7** Initiating and notification circuits shall be checked for end-of-line devices, if required.
- N 7.7.1.8** All supervised circuits shall be tested for trouble response.
- N 7.7.2 System Functional Operational Test.**
- N 7.7.2.1** Each detection initiating circuit shall be operated to verify that all alarm functions occur according to design specifications.
- N 7.7.2.2** Each manual release shall be operated to verify that manual release functions occur according to design specifications.
- N 7.7.2.3** Each abort switch circuit shall be operated to verify that abort functions occur according to design specifications and that visual and audible supervisory signals are annunciated at the control panel.
- N 7.7.2.4** All automatic valves shall be tested to verify operation unless testing the valve will release agent or damage the valve (destructive testing).
- N 7.7.2.5** Pneumatic equipment, where installed, shall be tested for integrity to ensure operation.
- N 7.7.3 Remote Monitoring Operations.**
- N 7.7.3.1** Each type of initiating device shall be operated while on standby power to verify that an alarm signal is received at the remote panel after the device is operated.

N 7.7.3.2 A fault condition shall be applied to each initiating or notification circuit to verify receipt of a trouble condition at the remote station.

N 7.7.3.3 Each supervised device shall be operated to verify receipt of a supervisory condition at the remote station.

N 7.7.4 Control Panel Primary Power Source. A primary power failure shall be initiated in accordance with the manufacturer's specification to verify that the system operates on standby power.

N 7.7.5 Return of System to Operational Condition.

N 7.7.5.1 When functional testing is completed, the system shall be returned to its fully operational condition.

N 7.7.5.2 The alarm-receiving office and all concerned personnel at the end user's facility shall be notified that the fire system test is complete and that the system has been returned to full service condition.

N 7.8 Owner's Documentation.

N 7.8.1 Paper or electronic copies of all test reports and related documentation shall be provided to the system owner.

N 7.8.2 The system owner shall maintain these reports for the life of the system.

N 7.9 Training.

N 7.9.1 All persons who could be expected to operate fire extinguishing systems shall be trained and kept trained in the functions they are expected to perform.

N 7.9.2* Personnel working in an enclosure protected by a clean agent shall receive training regarding agent safety issues.

N Chapter 8 Inspection, Servicing, Testing, Maintenance, and Training

N 8.1 General. The responsibility for inspection, testing, maintenance, and recharging of the fire protection system shall ultimately be that of the owner(s) of the system, provided that this responsibility has not been transferred in written form to a management company, tenant, or other party.

N 8.1.1 Safety. Safe procedures shall be observed during inspection, servicing, maintenance, testing, handling, and recharging of clean agent systems and agent containers. (*See A. 7.1.*)

N 8.1.2 Fire Protection Service Technician. Personnel that inspect, service, test, and maintain clean agent fire extinguishing systems shall have knowledge and experience of the maintenance and servicing requirements contained in this standard, of the equipment being serviced or maintained, and of the servicing or maintenance methods and requirements contained in the manufacturer's design, installation, and maintenance manual and any applicable bulletins.

N 8.2* Monthly Inspection.

N 8.2.1 At least monthly, a visual inspection shall be conducted in accordance with the manufacturer's listed maintenance manual or owner's manual.

N 8.2.2 At a minimum, the inspection shall include verification of the following, as applicable:

- (1) Releasing panel is powered and is free of supervisory, trouble, or alarm conditions.
- (2) Manual controls are unobstructed.
- (3) System shows no physical damage or condition that could prevent operation.
- (4) Pressure gauges are in the operable range.
- (5) Protected equipment and/or hazard has not been changed or modified.
- (6) Any previously noted deficiencies have been corrected.

N 8.2.3 If any deficiencies are found, appropriate corrective action shall be taken immediately.

N 8.2.4 Where the corrective action involves maintenance or repair, it shall be conducted by a fire protection service technician, in accordance with 8.1.2.

N 8.2.5 When inspections are conducted, a record verifying that the inspection was completed shall be maintained by the owner.

N 8.2.5.1 The record shall include the date the inspection was performed and the initials of the person performing the inspection.

N 8.2.5.2 The record shall include any deficiencies that were found.

N 8.2.5.3 The records shall be retained until the next semiannual service and inspection.

N 8.3 Semiannual Service and Inspection. At least semiannually, the agent quantity and pressure of refillable containers shall be checked.

N 8.3.1 For halocarbon clean agents with a means of pressure indication, if a container shows a loss in agent quantity of more than 5 percent or a loss in pressure (adjusted for temperature) of more than 10 percent, it shall be refilled or replaced.

N 8.3.2 For halocarbon agent containers without a means of pressure indication, if a container shows a loss in agent quantity of more than 5 percent, it shall be refilled or replaced.

N 8.3.3* Halocarbon clean agent removed from containers during service or maintenance procedures shall be recovered and recycled or disposed of in accordance with any applicable laws and regulations.

N 8.3.4* For inert gas clean agents, if a container shows a loss in pressure (adjusted for temperature) of more than 5 percent, it shall be refilled or replaced.

N 8.3.5 Where container pressure gauges are used to comply with 8.3.4, they shall be compared to a separate calibrated device at least annually.

N 8.3.6 Where the quantity of agent in the container is determined by special measuring devices, these devices shall be listed.

N 8.3.7 The following information shall be recorded on a tag attached to the container:

- (1) Date of inspection
- (2) Person performing the inspection
- (3) Type of agent
- (4) Gross weight of the container and net weight of agent (*halocarbon clean agents only*)
- (5) Container pressure and temperature (*halocarbon clean agents with a gauge and inert gas clean agents*)

- N 8.4 Annual Inspection and Service.** At least annually, all systems shall be inspected, serviced, and tested for operation by qualified personnel, in accordance with 8.1.2.
- N 8.4.1** Discharge tests shall not be required.
- N 8.4.2*** A service report with recommendations shall be filed with the owner of the system.
- N 8.4.3** The service report shall be permitted to be stored and accessed using paper or electronic media.
- N 8.4.4 System Hoses.**
- N 8.4.4.1** All system hoses shall be examined annually for damage.
- N 8.4.4.2** If visual examination shows any deficiency, the hose shall be immediately replaced or tested as specified in Section 8.7.
- N 8.4.5 Enclosure Inspection.**
- N 8.4.5.1** The protected enclosure shall be inspected annually or monitored by a documented administrative program for changes in barrier integrity or enclosure dimensions.
- N 8.4.5.2*** Where changes could result in the inability of the enclosure to maintain the clean agent concentration, the conditions shall be corrected.
- N 8.5* Maintenance.**
- N 8.5.1** These systems shall be maintained in full operating condition at all times.
- N 8.5.2** Actuation, impairment, and restoration of this protection shall be reported promptly to the authority having jurisdiction.
- N 8.5.3** Any impairments shall be corrected.
- N 8.5.4 Enclosure Maintenance.**
- N 8.5.4.1*** Any penetrations made through the enclosure protected by the clean agent shall be sealed immediately.
- N 8.5.4.2** The method of sealing shall restore the original fire resistance rating of the enclosure.
- N 8.6* Container Test.**
- N 8.6.1*** U.S. Department of Transportation (DOT), Canadian Transport Commission (CTC), or similar design clean agent containers shall not be recharged without retesting if more than 5 years have elapsed since the date of the last test and inspection.
- N 8.6.1.1** For halocarbon agent storage containers, the retest shall be permitted to consist of a complete visual inspection as described in 49 CFR.
- N 8.6.1.2** For inert gas agent storage containers, the retest shall be in accordance with U.S. Department of Transportation (DOT), Canadian Transport Commission (CTC), or similar design and requalification regulations.
- N 8.6.2*** Containers continuously in service without discharging shall be given a complete external visual inspection every 5 years or more frequently if required.
- N 8.6.2.1** The visual inspection shall be in accordance with Section 3 of CGA C-6, except that the containers need not be stamped while under pressure.
- N 8.6.2.2** The results of the inspection shall be recorded on both of the following:
- (1) A record tag permanently attached to each container
 - (2) A suitable inspection report
- N 8.6.2.3** A completed copy of the container inspection report shall be furnished to the owner of the system or an authorized representative.
- N 8.6.2.4** These records shall be retained by the owner for the life of the system.
- N 8.6.2.5** Where external visual inspection indicates that the container has been damaged, additional strength tests shall be required in accordance with applicable transportation regulations.
- N 8.7 Hose Test.**
- N 8.7.1** All hoses shall be tested or replaced every 5 years.
- N 8.7.2** A test pressure equal to 1½ times the maximum container pressure at 130°F (54.4°C) shall be applied within 1 minute and maintained for 1 minute.
- N 8.7.3** The testing procedure shall be as follows:
- (1) The hose is removed from any attachment.
 - (2) The hose assembly is then placed in a protective enclosure designed to permit visual observation of the test.
 - (3) The hose must be completely filled with water before testing.
 - (4) Pressure then is applied at a rate-of-pressure rise to reach the test pressure within 1 minute. The test pressure is then maintained for 1 full minute. Observations are then made to note any distortion or leakage.
 - (5) After observing the hose for leakage, movement of couplings, and distortion, the pressure is released.
- N 8.7.4** The hose assembly shall be considered to pass if all of the following criteria are met:
- (1) No loss of pressure during the test
 - (2) No movement of the couplings while under pressure
 - (3) No permanent distortion of the hose
- N 8.7.5** Each hose assembly that passes the hydrostatic test shall be marked with the date of the test.
- N 8.7.6*** Each hose assembly that passed the test shall be dried internally before being reinstalled.
- N 8.7.7** Each hose assembly that fails the hydrostatic test shall be marked and destroyed.
- N 8.8 Training.** All persons who could be expected to inspect, service, test, or maintain fire extinguishing systems shall be trained and kept trained in the functions they are expected to perform.

Chapter 9 Marine Systems

9.1 General. This chapter outlines the deletions, modifications, and additions that are necessary for marine applications. All other requirements of NFPA 2001 shall apply to shipboard systems except as modified by this chapter. Where the provisions of Chapter 9 conflict with the provisions of Chapter 1 through Chapter 8, the provisions of Chapter 9 shall take precedence.

9.1.1 Scope. This chapter is limited to marine applications of clean agent fire extinguishing systems on commercial and government vessels. Explosion inerting systems were not considered during development of this chapter.

9.2 Use and Limitations.

9.2.1* Total flooding clean agent fire extinguishing systems shall be used primarily to protect hazards that are in enclosures or equipment that, in itself, includes an enclosure to contain the agent.

9.2.2* In addition to the limitations given in 1.4.2.2, clean agent fire extinguishing systems shall not be used to protect the following:

- (1) Dry cargo holds
- (2) Bulk cargo

9.2.3 The effects of agent decomposition products and combustion products on fire protection effectiveness and equipment shall be considered where using clean agents in hazards with high ambient temperatures (e.g., incinerator rooms, hot machinery and piping).

9.3 Hazards to Personnel.

9.3.1 Other than the engine rooms identified in 9.3.1.1, all other main machinery spaces shall be considered normally occupied spaces.

9.3.1.1 Engine rooms of 6000 ft³ (170 m³) or less that are accessed for maintenance only shall not be required to comply with 9.3.1.

9.3.2* For marine systems, electrical clearances shall be in accordance with 46 CFR, Subchapter J, "Electrical Engineering."

9.4 Agent Supply.

9.4.1 Reserve quantities of agent shall not be required by this standard.

9.4.2* Storage container arrangement shall be in accordance with 4.1.3.1 and 4.1.3.3 through 4.1.3.5. Where equipment is subject to extreme weather conditions, the system shall be installed in accordance with the manufacturer's design and installation instructions.

9.4.2.1 Except in the case of systems with storage cylinders located within the protected space, pressure containers required for the storage of the agent shall be in accordance with 9.4.2.2.

9.4.2.2 Where the agent containers are located outside a protected space, they shall be stored in a room that shall be situated in a safe and readily accessible location and shall be effectively ventilated so that the agent containers are not exposed to ambient temperatures in excess of 130°F (55°C). Common bulkheads and decks located between clean agent

container storage rooms and protected spaces shall be protected with A-60 class structural insulation as defined by 46 CFR 72. Agent container storage rooms shall be accessible without having to pass through the space being protected. Access doors shall open outward, and bulkheads and decks, including doors and other means of closing any opening therein, that form the boundaries between such rooms and adjoining spaces shall be gastight.

9.4.3 Where agent containers are stored in a dedicated space, doors at exits shall swing outward.

9.4.4 Where subject to moisture, containers shall be installed such that a space of at least 2 in. (51 mm) between the deck and the bottom of the container is provided.

9.4.5 In addition to the requirements of 4.1.3.4, containers shall be secured with a minimum of two brackets to prevent movement from vessel motion and vibration.

9.4.6* For marine applications, all piping, valves, and fittings of ferrous materials shall be protected inside and out against corrosion except as permitted in 9.4.6.1.

9.4.6.1 Closed sections of pipe and valves and fittings within closed sections of pipe shall be required to be protected against corrosion only on the outside.

9.4.6.2 Other than as permitted in 9.4.6.1, prior to acceptance testing, the inside of the piping shall be cleaned without compromising its corrosion resistance.

9.4.7* Pipes, fittings, nozzles, and hangers, including welding filling materials, within the protected space shall have a melting temperature greater than 1600°F (871°C). Aluminum components shall not be used.

9.4.8 Piping shall extend at least 2 in. (51 mm) beyond the last nozzle in each branch line to prevent clogging.

9.5 Detection, Actuation, and Control Systems.

9.5.1 General.

9.5.1.1 Detection, actuation, alarm, and control systems shall be installed, tested, and maintained in accordance with the requirements of the authority having jurisdiction.

9.5.1.2* For spaces greater than 6000 ft³ (170 m³), automatic release of the fire extinguishing agent shall not be permitted where actuation of the system can interfere with the safe navigation of the vessel. Automatic release of the fire extinguishing agent shall be permitted for any space where actuation of the system will not interfere with the safe navigation of the vessel.

9.5.1.2.1 Automatic release shall be permitted for any space of 6000 ft³ (170 m³) or less.

9.5.2 Automatic Detection.

9.5.2.1 Electrical detection, signaling, control, and actuation system(s) shall have at least two sources of power. The primary source shall be from the vessel's emergency bus. For vessels with an emergency bus or battery, the backup source shall be either the vessel's general alarm battery or an internal battery within the system. Internal batteries shall be capable of operating the system for a minimum of 24 hours. All power sources shall be supervised.

9.5.2.1.1 For vessels without an emergency bus or battery, the primary source shall be permitted to be the main electrical supply.

9.5.2.2 In addition to the requirements set forth in 4.3.3.5, actuation circuits shall not be routed through the protected space where manual electrical actuation is used in marine systems.

9.5.2.2.1 For systems complying with 9.5.2.4, actuation circuits shall be permitted to be routed through the protected space.

9.5.2.3* Manual actuation for systems shall not be capable of being put into operation by any single action. Other than as identified in 9.5.2.3.1, manual actuation stations shall be housed in an enclosure.

9.5.2.3.1 Manual actuation shall be permitted to be local manual actuation at the cylinder(s) location.

9.5.2.4 Systems protecting spaces larger than 6000 ft³ (170 m³) shall have a manual actuation station located in the main egress route outside the protected space. In addition, systems protecting spaces larger than 6000 ft³ (170 m³) having cylinders within the protected space and systems protecting unattended main machinery spaces shall have an actuation station in a continuously monitored control station outside the protected space.

9.5.2.4.1 Systems protecting spaces of 6000 ft³ (170 m³) or less shall be permitted to have a single actuation station at either of the locations described in 9.5.2.4.

9.5.2.5 Emergency lighting shall be provided for remote actuation stations serving systems protecting main machinery spaces. All manual operating devices shall be labeled to identify the hazards they protect. In addition, the following information shall be provided:

- (1) Operating instructions
- (2) Length of time delay
- (3) Actions to take if system fails to operate
- (4) Other actions to take such as closing vents and taking a head count

9.5.2.5.1 For systems having cylinders within the protected space, a means of indicating system discharge shall be provided at the remote actuation station.

9.6 Additional Requirements for Systems Protecting Class B Hazards Greater Than 6000 ft³ (170 m³) with Stored Cylinders Within the Protected Space.

9.6.1* An automatic fire detection system shall be installed in the protected space to provide early warning of fire to minimize potential damage to the fire extinguishing system before it can be manually actuated. The detection system shall initiate audible and visual alarms in the protected space and on the navigating bridge upon detection of fire. All detection and alarm devices shall be electrically supervised for continuity, and trouble indication shall be annunciated on the navigating bridge.

9.6.2* Electrical power circuits connecting the containers shall be monitored for fault conditions and loss of power. Visual and audible alarms shall be provided to indicate this, and the alarms shall be annunciated on the navigating bridge.

9.6.3* Within the protected space, electrical circuits essential for the release of the system shall be heat resistant, such as mineral-insulated cable compliant with Article 332 of *NFPA 70*, or the equivalent. Piping systems essential for the release of systems designed to be operated hydraulically or pneumatically shall be of steel or other equivalent heat-resistant material.

9.6.4* The arrangements of containers and the electrical circuits and piping essential for the release of any system shall be such that in the event of damage to any one power release line through fire or explosion in a protected space (i.e., a single-fault concept) the entire fire extinguishing charge required for that space can still be discharged.

9.6.5* The containers shall be monitored for decrease in pressure due to leakage and discharge. Visual and audible signals in the protected area and either on the navigating bridge or in the space where the fire control equipment is centralized shall be provided to indicate a low-pressure condition.

9.6.6* Within the protected space, electrical circuits essential for the release of the system shall be Class A rated in accordance with *NFPA 72*.

9.7 Enclosure.

9.7.1* To prevent loss of agent through openings to adjacent hazards or work areas, openings shall be one of the following designs:

- (1) Permanently sealed
- (2) Equipped with automatic closures
- (3) Equipped with manual closures outfitted with an alarm circuit to indicate when these closures are not sealed upon activation of the system

9.7.1.1 Where confinement of agent is not practical, or if the fuel can drain from one compartment to another, such as via a bilge, protection shall be extended to include the adjacent connected compartment or work areas.

9.7.2* Prior to agent discharge, all ventilating systems shall be closed and isolated to preclude passage of agent to other compartments or the vessel exterior. Automatic shutdowns or manual shutdowns capable of being closed by one person from a position co-located with the agent discharge station shall be used.

9.8 Design Concentration Requirements.

9.8.1 Combinations of Fuels. For combinations of fuels, the design concentration shall be derived from the flame extinguishment value for the fuel requiring the greatest concentration.

9.8.2 Design Concentration. For a particular fuel, the design concentration referred to in 9.8.3 shall be used.

9.8.3 Flame Extinguishment. The minimum design concentration for Class B flammable and combustible liquids shall be as determined following the procedures described in IMO MSC/Circ. 848, as amended by IMO MSC.1/Circ. 1267.

9.8.4* Total Flooding Quantity. The quantity of agent shall be based on the net volume of the space and shall be in accordance with the requirements of paragraph 5 of IMO MSC/Circular 848, Annex.

9.8.5* Duration of Protection. It is important that the agent design concentration not only shall be achieved, but also shall be maintained for a sufficient period of time to allow effective emergency action by trained ship's personnel. In no case shall the hold time be less than 15 minutes.

9.9 Distribution System.

9.9.1 Rate of Application. The minimum design rate of application shall be based on the quantity of agent required for the desired concentration and the time allowed to achieve the desired concentration.

9.9.2 Discharge Time.

9.9.2.1 The discharge time for halocarbon agents shall not exceed 10 seconds or as otherwise required by the authority having jurisdiction.

9.9.2.2 For halocarbon agents, the discharge time period shall be defined as the time required to discharge from the nozzles 95 percent of the agent mass [at 70°F (21°C)] necessary to achieve the minimum design concentration.

9.9.2.3 The discharge time for inert gas agents shall not exceed 120 seconds for 85 percent of the design concentration or as otherwise required by the authority having jurisdiction.

9.10 Nozzle Choice and Location. For spaces other than those identified in 9.10.1, nozzles shall be of the type listed for the intended purpose. Limitations shall be determined based on testing in accordance with IMO MSC/Circular 848. Nozzle spacing, area coverage, height, and alignment shall not exceed the limitations.

9.10.1 For spaces having only Class A fuels, nozzle placement shall be in accordance with the nozzles' listed limitations.

9.11 Inspection and Tests. At least annually, all systems shall be inspected and tested for proper operation by competent personnel. Discharge tests shall not be required.

9.11.1 An inspection report with recommendations shall be filed with the vessel's master and the owner's agent. The report shall be available for inspection by the authority having jurisdiction.

9.11.2 At least annually, the agent quantity of refillable containers shall be checked by competent personnel. The container pressure shall be verified and logged at least monthly by the vessel's crew.

9.11.3* For halocarbon clean agents, if a container shows a loss in agent of more than 5 percent or a loss in pressure, adjusted for temperature, of more than 10 percent, it shall be **refilled** or replaced.

9.11.3.1* If an inert gas clean agent container shows a loss in pressure, adjusted for temperature, of more than 5 percent, it shall be refilled or replaced. Where container pressure gauges are used for this purpose, they shall be compared to a separate calibrated device at least annually.

9.11.4 The installing contractor shall provide instructions for the operational features and inspection procedures specific to the clean agent system installed on the vessel.

9.12 Approval of Installations. Prior to acceptance of the system, technical documentation, such as the system design manual, test reports, or the listing report, shall be presented to the authority having jurisdiction. This documentation shall

show that the system and its individual components are compatible, employed within tested limitations, and suitable for marine use.

9.12.1 The listing organization shall perform the following functions:

- (1) Verify that fire tests were conducted in accordance with a predetermined standard
- (2) Verify that component tests were conducted in accordance with a predetermined standard
- (3) Review the component quality assurance program
- (4) Review the design and installation manual
- (5) Identify system and component limitations
- (6) Verify flow calculations
- (7) Verify the integrity and the reliability of system as a whole
- (8) Have a follow-up program
- (9) Publish a list of equipment

9.13 Periodic Puff Testing. A test in accordance with 7.4.15 shall be performed at 24-month intervals. The periodic test program shall include a functional test of all alarms, controls, and time delays.

9.14 Compliance. Electrical systems shall be in accordance with 46 CFR Subchapter J. For Canadian vessels, electrical installations shall be in accordance with TP 127 E.

Annex A Explanatory Material

Annex A is not a part of the requirements of this NFPA document but is included for informational purposes only. This annex contains explanatory material, numbered to correspond with the applicable text paragraphs.

Δ A.1.4.1 The agents currently listed possess the physical properties as detailed in Table A.1.4.1(a) through Table A.1.4.1(d). These data will be revised from time to time as new information becomes available. Additional background information and data on these agents can be found in several references: Fernandez (1991), Hanauska (1991), Robin (1991), and Sheinson (1991).

A.1.4.1.2 The designations for perfluorocarbons (FCs), hydrochlorofluorocarbons (HCFCs), hydrofluorocarbons (HFCs), fluoroiodocarbons (FICs), and fluoroketones (FKs) are an extension of halocarbon designations in ANSI/ASHRAE 34, prepared by the American National Standards Institute, Inc. (ANSI) and ASHRAE. HCFC Blend A is a designation for a blend of HCFCs and a hydrocarbon. The designation IG-541 is used in this standard for a blend of three inert gases — nitrogen, argon, and carbon dioxide (52 percent, 40 percent, and 8 percent, respectively). The designation IG-01 is used in this standard for argon, an unblended inert gas. The designation IG-100 is used in this standard for nitrogen, an unblended inert gas. The designation IG-55 is used in this standard for a blend of two inert gases — nitrogen and argon (50 percent each).

A.1.4.2 Clean agent fire extinguishing systems are useful within the limits of this standard for extinguishing fires in specific hazards or equipment and in occupancies where an electrically nonconductive medium is essential or desirable or where cleanup of other media presents a problem.

Table A.1.4.1(a) Physical Properties of Clean Halocarbon Agents (U.S. Units)

Physical Property	Units	FIC-131I	FK-5-1-12	HCFC Blend A	HFC Blend B	HCFC-124	HFC-125	HFC-227ea	HFC-23	HFC-236fa
Molecular weight	N/A	195.9	316.04	92.9	99.4	136.5	120.0	170	70.01	152
Boiling point at 760 mm Hg	°F	-8.5	120.2	-37	-14.9	10.5	-54	2.4	-115.6	29.5
Freezing point	°F	-166	-162.4	161	-153.9	-326	-153	-204	-247.4	-153.4
Critical temperature	°F	252	335.6	256	219.9	252.5	150.8	214	79.1	256.9
Critical pressure	psi	586	270.44	964	588.9	527	525	424	700	464.1
Critical volume	ft ³ /lbm	0.0184	0.0251	0.028	0.031	0.0286	0.0279	0.0280	0.0304	0.02905
Critical density	lbm/ft ³	54.38	39.91	36	32.17	34.96	35.81	35.77	32.87	34.42
Specific heat, liquid at 77°F	Btu/lb-°F	0.141	0.2634	0.3	0.339	0.271	0.354	0.281	0.987 at 68°F	0.3012
Specific heat, vapor at constant pressure (1 atm) and 77°F	Btu/lb-°F	0.86	0.2127	0.16	0.203	0.18	0.19	0.193	0.175 at 68°F	0.201
Heat of vaporization at boiling point	Btu/lb	48.1	37.8	97	93.4	71.3	70.5	56.6	103	68.97
Thermal conductivity of liquid at 77°F	Btu/hr-ft-°F	0.04	0.034	0.052	0.0478	0.0395	0.0343	0.034	0.0305	0.0421
Viscosity, liquid at 77°F	lb/ft-hr	0.473	1.27	0.508	0.485	0.622	0.338	0.579	0.107	0.6906
Relative dielectric strength at 1 atm at 734 mm Hg, (N ₂ = 1)	N/A	1.41 at 77°F	2.3 at 77°F	1.32 at 77°F	1.014 at 77°F	1.55 at 77°F	0.955 at 70°F	2 at 77°F	1.04 at 77°F	1.0166 at 77°F
Solubility of water in agent	wt%	0.01 at 70°F	<0.001 at 70°F	0.12 at 70°F	0.11 at 70°F	770 at 77°F	770 at 77°F	0.06 at 70°F	500 at 50°F	740 at 68°F

Table A.1.4.1(b) Physical Properties of Inert Gas Agents (U.S. Units)

Physical Property	Units	IG-01	IG-100	IG-541	IG-55
Molecular weight	N/A	39.9	28.0	34.0	33.95
Boiling point at 760 mm Hg	°F	-302.6	-320.4	-320	-310.2
Freezing point	°F	-308.9	-346.0	-109	-327.5
Critical temperature	°F	-188.1	-232.4	N/A	-210.5
Critical pressure	psia	711	492.9	N/A	602
Specific heat, vapor at constant pressure (1 atm) and 77°F	Btu/lb °F	0.125	0.445	0.195	0.187
Heat of vaporization at boiling point	Btu/lb	70.1	85.6	94.7	77.8
Relative dielectric strength at 1 atm at 734 mm Hg, 77°F (N ₂ = 1.0)	N/A	1.01	1.0	1.03	1.01
Solubility of water in agent at 77°F	N/A	0.006%	0.0013%	0.015%	0.006%

Table A.1.4.1(c) Physical Properties of Clean Halocarbon Agents (SI Units)

Physical Property	Units			HCFC	HFC	HCFC-124	HFC-125	HFC-227ea	HFC-23	HFC-236fa
		FIC-1311	FK-5-1-12	Blend A	Blend B					
Molecular weight	N/A	195.91	316.04	92.90	99.4	136.5	120	170	70.01	152
Boiling point at 760 mm Hg	°C	-22.5	49	-38.3	-26.1	-12.0	-48.1	-16.4	-82.1	-1.4
Freezing point	°C	-110	-108	<107.2	-103	-198.9	-102.8	-131	-155.2	-103
Critical temperature	°C	122	168.66	124.4	101.1	122.6	66	101.7	26.1	124.9
Critical pressure	kPa	4041	1865	6647	4060	3620	3618	2912	4828	3200
Critical volume	cc/mole	225	494.5	162	198	243	210	274	133	276*
Critical density	kg/m ³	871	639.1	577	515.3	560	574	621	527	551.3
Specific heat, liquid at 25°C	kJ/kg - °C	0.592 at 25°C	1.103 at 25°C	1.256 at 25°C	1.44 at 25°C	1.153 at 25°C	1.407 at 25°C	1.184 at 25°C	4.130 at 20°C	1.264 at 25°C
Specific heat, vapor at constant pressure (1 atm) and 25°C	kJ/kg - °C	0.3618 at 25°C	0.891 at 25°C	0.67 at 25°C	0.848 at 25°C	0.742 at 25°C	0.797 at 25°C	0.808 at 25°C	0.731 at 20°C	0.840 at 25°C
Heat of vaporization at boiling point	kJ/kg	112.4	88	225.6	217.2	165.9	164.1	132.6	239.3	160.4
Thermal conductivity of liquid at 25°C	W/m - °C	0.07	0.059	0.09	0.082	0.0684	0.0592	0.069	0.0534	0.0729
Viscosity, liquid at 25°C	centipoise	0.196	0.524	0.21	0.202	0.257	0.14	0.184	0.044	0.286
Relative dielectric strength at 1 atm at 734 mm Hg (N ₂ = 1.0)	N/A	1.41 at 25°C	2.3 at 25°C	1.32 at 25°C	1.014 at 25°C	1.55 at 25°C	0.955 at 21°C	2 at 25°C	1.04 at 25°C	1.0166 at 25°C
Solubility of water in agent	ppm	1.0062% by weight	<0.001	0.12% by weight	0.11% by weight	700 at 25°C	700 at 25°C	0.06% by weight	500 at 10°C	740 at 20°C

Table A.1.4.1(d) Physical Properties of Inert Gas Agents (SI Units)

Physical Property	Units	IG-01	IG-100	IG-541	IG-55
Molecular weight	N/A	39.9	28.0	34.0	33.95
Boiling point at 760 mm Hg	°C	-189.85	-195.8	-196	-190.1
Freezing point	°C	-189.35	-210.0	-78.5	-199.7
Critical temperature	°C	-122.3	-146.9	N/A	-134.7
Critical pressure	kPa	4,903	3,399	N/A	4,150
Specific heat, vapor at constant pressure (1 atm) and 25°C	kJ/kg °C	0.519	1.04	0.574	0.782
Heat of vaporization at boiling point	kJ/kg	163	199	220	181
Relative dielectric strength at 1 atm at 734 mm Hg, 25°C (N ₂ = 1.0)	N/A	1.01	1.0	1.03	1.01
Solubility of water in agent at 25°C	N/A	0.006%	0.0013%	0.015%	0.006%

Total flooding clean agent fire extinguishing systems are used primarily to protect hazards that are in enclosures or equipment that, in itself, includes an enclosure to contain the agent. Some typical hazards that could be suitable include, but are not limited to, the following:

- (1) Electrical and electronic hazards
- (2) Subfloors and other concealed spaces
- (3) Flammable and combustible liquids and gases
- (4) Other high-value assets
- (5) Telecommunications facilities

Clean agent systems could also be used for explosion prevention and suppression where flammable materials could collect in confined areas.

A.1.4.2.3 The provision of an enclosure can create an unnecessary explosion hazard where otherwise only a fire hazard exists. A hazard analysis should be conducted to determine the relative merits of differing design concepts — for example, with and without enclosures — and the most relevant means of fire protection.

NA.1.4.2.4 This provision provides consideration for using a clean agent in an environment that could result in an inordinate amount of products of decomposition (e.g., within an oven).

A.1.5.1 Potential hazards to be considered for individual systems are the following:

- (1) *Noise*. Discharge of a system can cause noise loud enough to be startling but ordinarily insufficient to cause traumatic injury.
- (2) *Turbulence*. High-velocity discharge from nozzles could be sufficient to dislodge substantial objects directly in the path. System discharge can cause enough general turbulence in the enclosures to move unsecured paper and light objects.
- (3) *Cold temperature*. Direct contact with the vaporizing liquid being discharged from a system will have a strong chilling effect on objects and can cause frostbite burns to the skin. The liquid phase vaporizes rapidly when mixed with air and thus limits the hazard to the immediate vicinity of the discharge point. In humid atmospheres, minor reduction in visibility can occur for a brief period due to the condensation of water vapor.

A.1.5.1.1 The discharge of clean agent systems to extinguish a fire could create a hazard to personnel from the natural form of the clean agent or from the products of decomposition that result from exposure of the agent to the fire or hot surfaces. Unnecessary exposure of personnel either to the natural agent or to the decomposition products should be avoided.

The SNAP Program was originally outlined in the *Federal Register*, “EPA SNAP Program.”

Δ A.1.5.1.2 Table A.1.5.1.2(a) provides information on the toxicological effects of halocarbon agents covered by this standard. The no observable adverse effect level (NOAEL) is the highest concentration at which no adverse physiological or toxicological effect has been observed. The lowest observable adverse effect level (LOAEL) is the lowest concentration at which an adverse physiological or toxicological effect has been observed.

An appropriate protocol measures the effect in a stepwise manner such that the interval between the LOAEL and NOAEL is sufficiently small to be acceptable to the competent

regulatory authority. The EPA includes in its SNAP evaluation this aspect (of the rigor) of the test protocol.

For halocarbons covered in this standard, the NOAEL and LOAEL are based on the toxicological effect known as cardiac sensitization. Cardiac sensitization occurs when a chemical causes an increased sensitivity of the heart to adrenaline, a naturally occurring substance produced by the body during times of stress, leading to the sudden onset of irregular heart beats and possibly heart attack. Cardiac sensitization is measured in dogs after they have been exposed to a halocarbon agent for 5 minutes. At the 5-minute time period, an external dose of adrenaline (epinephrine) is administered and an effect is recorded if the dog experiences cardiac sensitization. The cardiac sensitization potential as measured in dogs is a highly conservative indicator of the potential in humans. The conservative nature of the cardiac sensitization test stems from several factors; the two most pertinent are as follows:

- (1) Very high doses of adrenaline are given to the dogs during the testing procedure (doses are more than 10 times higher than the highest levels secreted by humans under maximum stress).
- (2) Four to ten times more halocarbon is required to cause cardiac sensitization in the absence of externally administered adrenaline, even in artificially created situations of stress or fright in the dog test.

Because the cardiac sensitization potential is measured in dogs, a means of providing human relevance to the concentration at which this cardiac sensitization occurs (LOAEL) has been established through the use of physiologically based pharmacokinetic (PBPK) modeling.

A PBPK model is a computerized tool that describes time-related aspects of a chemical's distribution in a biological system. The PBPK model mathematically describes the uptake of the halocarbon into the body and the subsequent distribution of the halocarbon to the areas of the body where adverse effects can occur. For example, the model describes the breathing rate and uptake of the halocarbon from the exposure atmosphere into the lungs. From there, the model uses the blood flow bathing the lungs to describe the movement of the halocarbon from the lung space into the arterial blood that directly feeds the heart and vital organs of the body.

It is the ability of the model to describe the halocarbon concentration in human arterial blood that provides its primary utility in relating the dog cardiac sensitization test results to a human who is unintentionally exposed to the halocarbon. The concentration of halocarbon in the dog arterial blood at the time the cardiac sensitization event occurs (5-minute exposure) is the critical arterial blood concentration, and this blood parameter is the link to the human system. Once this critical arterial blood concentration has been measured in dogs, the EPA-approved PBPK model simulates how long it will take the human arterial blood concentration to reach the critical arterial blood concentration (as determined in the dog test) during human inhalation of any particular concentration of the halocarbon agent. As long as the simulated human arterial concentration remains below the critical arterial blood concentration, the exposure is considered safe. Inhaled halocarbon concentrations that produce human arterial blood concentrations equal to or greater than the critical arterial blood concentration are considered unsafe because they represent inhaled concentrations that potentially yield arterial blood concentrations where cardiac sensitization events

occur in the dog test. Using these critical arterial blood concentrations of halocarbons as the ceiling for allowable human arterial concentrations, any number of halocarbon exposure scenarios can be evaluated using this modeling approach.

For example, in the dog cardiac sensitization test on Halon 1301, a measured dog arterial blood concentration of 25.7 mg/L is measured at the effect concentration (LOAEL) of 7.5 percent after a 5-minute exposure to Halon 1301 and an external intravenous adrenaline injection. The PBPK model predicts the time at which the human arterial blood concentration reaches 25.7 mg/L for given inhaled Halon 1301 concentrations. Using this approach, the model also predicts that at some inhaled halocarbon concentrations, the critical arterial blood concentration is never reached; thus, cardiac sensitization will not occur. Accordingly, in the tables in 1.5.1.2.1, the time is arbitrarily truncated at 5 minutes, because the dogs were exposed for 5 minutes in the original cardiac sensitization testing protocols.

The time value, estimated by the EPA-approved and peer-reviewed PBPK model or its equivalent, is that required for the human arterial blood level for a given halocarbon to equal the arterial blood level of a dog exposed to the LOAEL for 5 minutes.

For example, if a system is designed to achieve a maximum concentration of 12.0 percent HFC-125, means should be provided such that personnel are exposed for no longer than 1.67 minutes. Examples of suitable exposure-limiting mechanisms include self-contained breathing apparatuses and planned and rehearsed evacuation routes.

The requirement for pre-discharge alarms and time delays is intended to prevent human exposure to agents during fire fighting. However, in the unlikely circumstance that an accidental discharge occurs, restrictions on the use of certain halocarbon agents covered in this standard are based on the availability of PBPK modeling information. For those halocarbon agents in which modeling information is available, means should be provided to limit the exposure to those concentrations and times specified in the tables in 1.5.1.2.1. The concentrations and times given in the tables are those that have been predicted to limit the human arterial blood concentration to below the critical arterial blood concentration associated with cardiac sensitization. For halocarbon agents where the needed data are unavailable, the agents are restricted based on whether the protected space is normally occupied or unoccupied and how quickly egress from the area can be effected. Normally occupied areas are those intended for human occupancy. Normally unoccupied areas are those in which personnel can be present from time to time. Therefore, a comparison of the cardiac sensitization values to the intended design concentration would determine the suitability of a halocarbon for use in normally occupied or unoccupied areas.

Clearly, longer exposure of the agent to high temperatures would produce greater concentrations of these gases. The type and sensitivity of detection, coupled with the rate of discharge, should be selected to minimize the exposure time of the agent to the elevated temperature if the concentration of the breakdown products must be minimized. In most cases the area would be untenable for human occupancy due to the heat and breakdown products of the fire itself.

These decomposition products have a sharp, acrid odor, even in minute concentrations of only a few parts per million. This characteristic provides a built-in warning system for the agent but at the same time creates a noxious, irritating atmosphere for those who must enter the hazard following a fire.

Background and toxicology of hydrogen fluoride. Hydrogen fluoride (HF) vapor can be produced in fires as a breakdown product of fluorocarbon fire extinguishing agents and in the combustion of fluoropolymers.

The significant toxicological effects of HF exposure occur at the site of contact. By the inhalation route, significant deposition is predicted to occur in the most anterior (front part) region of the nose and extending back to the lower respiratory tract (airways and lungs) if sufficient exposure concentrations are achieved. The damage induced at the site of contact with HF is characterized by extensive tissue damage and cell death (necrosis) with inflammation. One day after a single, 1-hour exposure of rats to HF concentrations of 950 ppm to 2600 ppm, tissue injury was limited exclusively to the anterior section of the nose (DuPont, 1990). No effects were seen in the trachea or lungs.

At high concentrations of HF (about 200 ppm), human breathing patterns would be expected to change primarily from nose breathing to primarily mouth breathing. This change in breathing pattern determines the deposition pattern of HF into the respiratory tract, either upper respiratory tract (nose breathing) or lower respiratory tract (mouth breathing). In studies conducted by Dalby (1996), rats were exposed by nose-only or mouth-only breathing. In the mouth-only breathing model, rats were exposed to various concentrations of HF through a tube placed in the trachea, thereby bypassing the upper respiratory tract. This exposure method is considered to be a conservative approach for estimating a "worst-case" exposure in which a person would not breathe through the nose but inhale through the mouth, thereby maximizing the deposition of HF into the lower respiratory tract.

In the nose-only breathing model, 2-minute or 10-minute exposures of rats to about 6400 or 1700 ppm, respectively, produced similar effects; that is, no mortality resulted but significant cell damage in the nose was observed. In contrast, marked differences in toxicity were evident in the mouth-only breathing model. Indeed, mortality was evident following a 10-minute exposure to a concentration of about 1800 ppm and a 2-minute exposure to about 8600 ppm. Significant inflammation of the lower respiratory tract was also evident. Similarly, a 2-minute exposure to about 4900 ppm produced mortality and significant nasal damage. However, at lower concentrations (950 ppm) following a 10-minute exposure or 1600 ppm following a 2-minute exposure, no mortality and only minimal irritation were observed.

Numerous other toxicology studies have been conducted in experimental animals for longer durations, such as 15, 30, or 60 minutes. In nearly all of these studies, the effects of HF were generally similar across all species; that is, severe irritation of the respiratory tract was observed as the concentration of HF was increased.

In humans, an irritation threshold appears to be at about 3 ppm, where irritation of the upper airways and eyes occurs. In prolonged exposure at about 5 ppm, redness of the skin has also resulted. In controlled human exposure studies, humans are reported to have tolerated mild nasal irritation (subjective response) at 32 ppm for several minutes (Machle et al., 1934). Exposure of humans to about 3 ppm for an hour produced slight eye and upper respiratory tract irritation. Even with an increase in exposure concentration (up to 122 ppm) and a decrease in exposure duration to about 1 minute, skin, eye, and respiratory tract irritation occurs (Machle and Kitzmiller, 1935).

Meldrum (1993) proposed the concept of the dangerous toxic load (DTL) as a means of predicting the effects of, for example, HF in humans. Meldrum developed the argument that the toxic effects of certain chemicals tend to follow Haber's law:

[A.1.5.1.2]

$$C \times t = k$$

where:

C = concentration

t = time

k = constant

The available data on the human response to inhalation of HF were considered insufficient to provide a basis for establishing a DTL. Therefore, it was necessary to use the available animal lethality data to establish a model for the response in humans. The DTL is based on an estimate of 1 percent lethality in an exposed population of animals. Based on the analysis of animal lethality data, the author determined that the DTL for HF is 12,000 ppm/min. Although this approach appears reasonable and consistent with mortality data in experimental animals, the predictive nature of this relationship for nonlethal effects in humans has not been demonstrated.

Potential human health effects and risk analysis in fire scenarios. It is important for a risk analysis to distinguish between normally healthy individuals, such as fire fighters, and those with compromised health. Exposure to higher concentrations of HF would be expected to be tolerated more in healthy individuals, whereas equal concentrations can have escape-impairing effects in those with compromised health. The following discussion assumes that the effects described at the various concentrations and durations are for the healthy individual.

Inflammation (irritation) of tissues represents a continuum from "no irritation" to "severe, deep penetrating" irritation. Use of the terms *slight*, *mild*, *moderate*, and *severe* in conjunction with irritation represents an attempt to quantify this effect. However, given the large variability and sensitivity of the human population, differences in the degree of irritation from exposure to HF are expected to occur. For example, some individuals can experience mild irritation to a concentration that results in moderate irritation in another individual.

At concentrations of <50 ppm for up to 10 minutes, irritation of upper respiratory tract and the eyes would be expected to occur. At these low concentrations, escape-impairing effects would not be expected in the healthy individual. As HF concentrations increase to 50 ppm to 100 ppm, an increase in irritation is expected. For short duration (10 to 30 minutes), irritation of the skin, eyes, and respiratory tract would occur. At

100 ppm for 30 to 60 minutes, escape-impairing effects would begin to occur, and continued exposure at 200 ppm and greater for an hour could be lethal in the absence of medical intervention. As the concentration of HF increases, the severity of irritation increases, and the potential for delayed systemic effects also increases. At about 100 to 200 ppm of HF, humans would also be expected to shift their breathing pattern to mouth breathing. Therefore, deeper lung irritation is expected. At greater concentrations (>200 ppm), respiratory discomfort, pulmonary (deep lung) irritation, and systemic effects are possible. Continued exposure at these higher concentrations can be lethal in the absence of medical treatment.

Generation of HF from fluorocarbon fire extinguishing agents represents a potential hazard. In the foregoing discussion, the duration of exposure was indicated for 10 to 60 minutes. In fire conditions in which HF would be generated, the actual exposure duration would be expected to be less than 10 minutes and in most cases less than 5 minutes. As Dalby (1996) showed, exposing mouth-breathing rats to HF concentrations of about 600 ppm for 2 minutes was without effect. Similarly, exposing mouth-breathing rats to a HF concentration of about 300 ppm for 10 minutes did not result in any mortality or respiratory effects. Therefore, one could surmise that humans exposed to similar concentrations for less than 10 minutes would be able to survive such concentrations. However, caution needs to be employed in interpreting these data. Although the toxicity data would suggest that humans could survive these large concentrations for less than 10 minutes, those individuals with compromised lung function or those with cardiopulmonary disease can be more susceptible to the effects of HF. Furthermore, even in the healthy individual, irritation of the upper respiratory tract and eyes would be expected, and escape could be impaired.

Table A.1.5.1.2(b) provides potential human health effects of hydrogen fluoride in healthy individuals.

Occupational exposure limits have been established for HF. The limit set by the American Conference of Governmental Industrial Hygienists (ACGIH), the Threshold Limit Value (TLV[®]), represents exposure of normally healthy workers for an 8-hour workday or a 40-hour workweek. For HF, the limit established is 3 ppm, which represents a ceiling limit; that is, the airborne concentration that should not be exceeded at any time during the workday. This limit is intended to prevent irritation and possible systemic effects with repeated, long-term exposure. This and similar time-weighted average limits are not considered relevant for fire extinguishing use of fluorocarbons during emergency situations. However, these limits may need to be considered in clean-up procedures where high levels of HF were generated.

In contrast to the ACGIH TLV, the American Industrial Hygiene Association (AIHA) Emergency Response Planning Guideline (ERPG) represents limits established for emergency release of chemicals. These limits are established to also account for sensitive populations, such as those with compromised health. The ERPG limits are designed to assist emergency response personnel in planning for catastrophic releases of chemicals. These limits are not developed to be used as "safe" limits for routine operations. However, in the case of fire extinguishing use and generation of HF, these limits are more relevant than time-weighted average limits such as the TLV. The ERPG limits consist of three levels for use in emergency planning and are typically 1-hour values; 10-minute values have

also been established for HF. For the 1-hour limits, the ERPG 1 (2 ppm) is based on odor perception and is below the concentration at which mild sensory irritation has been reported (3 ppm). ERPG 2 (20 ppm) is the most important guideline value set and is the concentration at which mitigating steps should be taken, such as evacuation, sheltering, and donning masks. This level should not impede escape or cause irreversible health effects and is based mainly on the human irritation data obtained by Machle et al. (1934) and Largent (1960). ERPG 3 (50 ppm) is based on animal data and is the maximum nonlethal level for nearly all individuals. This level could be lethal to some susceptible people. The 10-minute values established for HF and used in emergency planning in fires where HF vapor is generated are ERPG 3 = 170 ppm, ERPG 2 = 50 ppm, and ERPG 1 = 2 ppm.

A.1.5.1.2.1 One objective of pre-discharge alarms and time delays is to prevent human exposure to agents.

A.1.5.1.3 Paragraph 1.5.1.3 makes reference to limiting concentrations of inert gas agents corresponding to certain values of “sea level equivalent” of oxygen. The mean atmospheric pressure of air at sea level is 760 mm Hg. Atmospheric air is 21 volume percent oxygen. The partial pressures of oxygen in ambient air and air diluted agent to the limiting sea level concentrations corresponding to permissible exposure times of 5 minutes, 3 minutes, and ½ minute are given in Table A.1.5.1.3(a).

In 3.3.35, *sea level equivalent of oxygen* is defined in terms of the partial pressure at sea level. The mean atmospheric pressure decreases with increasing altitude, as shown in Table 5.5.3.3. The partial pressure of oxygen is 21 percent of the atmospheric pressure. The concentration of added agent, which dilutes air to the sea level limiting partial pressure of oxygen, is given by

Table A.1.5.1.2(a) Toxicity Information for Halocarbon Clean Agents

Agent	LC ₅₀ or ALC (%)	NOAEL (%)	LOAEL (%)
FIC-131I	>12.8	0.2	0.4
FK-5-1-12	>10.0	10	>10.0
HCFC Blend A	64	10	>10.0
HCFC-124	23–29	1	2.5
HFC-125	>70	7.5	10
HFC-227ea	>80	9	10.5
HFC-23	>65	30	>30
HFC-236fa	>45.7	10	15
HFC Blend B	56.7*	5.0*	7.5*

Notes:

(1) LC₅₀ is the concentration lethal to 50 percent of a rat population during a 4 hour exposure. The ALC is the approximate lethal concentration.

(2) The cardiac sensitization levels are based on the observance or nonobservance of serious heart arrhythmias in a dog. The usual protocol is a 5-minute exposure followed by a challenge with epinephrine.

(3) High concentration values are determined with the addition of oxygen to prevent asphyxiation.

*These values are for the largest component of the blend (HFCB 134A).

▲

[A.1.5.1.3]

$$\text{Vol \% agent} = \frac{0.21P_{\text{ATM}} - P_{\text{O}_2, \text{LIM}}}{0.21P_{\text{ATM}}} \times 100$$

where:

P_{ATM} = local mean atmospheric pressure

$P_{\text{O}_2, \text{LIM}}$ = limiting partial pressure of oxygen corresponding to a sea level exposure time limit

The effect of altitude on limiting agent concentrations is given in Table A.1.5.1.3(b).

Table A.1.5.1.3(c) provides information on physiological effects of inert gas agents covered by this standard. The health concern for inert gas clean agents is asphyxiation due to the lowered oxygen levels. With inert gas agents, an oxygen concentration of no less than 10 percent (sea level equivalent) is required for normally occupied areas. This corresponds to an agent concentration of no more than 52 percent.

Table A.1.5.1.2(b) Potential Human Health Effects of Hydrogen Fluoride in Healthy Individuals

Exposure Time	Concentration of Hydrogen Fluoride (ppm)	Reaction
2 minutes	<50	Slight eye and nasal irritation
	50–100	Mild eye and upper respiratory tract irritation
	100–200	Moderate eye and upper respiratory tract irritation; slight skin irritation
	>200	Moderate irritation of all body surfaces; increasing concentration may be escape impairing
5 minutes	<50	Mild eye and nasal irritation
	50–100	Increasing eye and nasal irritation; slight skin irritation
	100–200	Moderate irritation of skin, eyes, and respiratory tract
10 minutes	<50	Definite irritation of tissue surfaces; will cause escape-impairing effects at increasing concentrations
	50–100	Definite irritation of tissue surfaces; will cause escape-impairing effects at increasing concentrations
	100–200	Definite irritation of tissue surfaces; will cause escape-impairing effects at increasing concentrations
10 minutes	<50	Definite eye, skin, and upper respiratory tract irritation
	50–100	Moderate irritation of all body surfaces
	100–200	Moderate irritation of all body surfaces; escape-impairing effects likely
10 minutes	>200	Escape-impairing effects will occur; increasing concentrations can be lethal without medical intervention

IG-541 uses carbon dioxide to promote breathing characteristics intended to sustain life in the oxygen-deficient environment for protection of personnel. Care should be used not to design inert gas-type systems for normally occupied areas using design concentrations higher than that specified in the system manufacturer's listed design manual for the hazard being protected.

Inert gas agents do not decompose measurably in extinguishing a fire. As such, toxic or corrosive decomposition products are not found. However, heat and breakdown products of the fire itself can still be substantial and could make the area untenable for human occupancy.

N A.1.5.1.4 Many studies have been conducted and technical guidance has been published regarding occupant egress time prediction. One source of such information is the *SFPE Handbook of Fire Protection Engineering, 5th Edition*. Various approaches are described, which can be used by the designer to calculate the available safe egress time (ASET) from a space protected by a clean agent extinguishing system. The ASET value can then be compared to required safe egress time (RSET), which is the maximum allowed exposure time limit in 1.5.1.2.1 and 1.5.1.3. The ASET value should be less than the RSET value. If the

△ Table A.1.5.1.3(a) Oxygen Partial Pressure at Sea Level Corresponding to Exposure Limits Given in 1.5.1.3

Exposure Time (min)	Agent Concentration (vol %)	O ₂ % at Sea Level	Partial Pressure of O ₂ (mm Hg)
Air reference	0	21	159.6
5	43	12.0	91.0
3	52	10.1	76.6
½	62	8.0	60.6

Note: Mean atmospheric pressure at sea level is 760 mm Hg.

△ Table A.1.5.1.3(b) Relationship of Altitude to Atmospheric Pressure, Oxygen Partial Pressure in Air, and Limiting Agent Concentration

Altitude Above Sea Level (ft)	P _{ATM} (mm Hg)	O ₂ Partial Pressure in Air (mm Hg)	Limiting Agent Concentration (vol %)		
			5 min Exposure P(O ₂) = 91 mm Hg	3 min Exposure P(O ₂) = 76.6 mm Hg	30 sec Exposure P(O ₂) = 60.6 mm Hg
-3,000	840	176.4	48.4	56.6	65.6
-2,000	812	170.5	46.6	55.1	64.5
-1,000	787	165.3	44.9	53.7	63.3
0	760	159.6	43.0	52.0	62.0
1,000	733	153.9	40.9	50.2	60.6
2,000	705	148.1	38.5	48.3	59.1
3,000	679	142.6	36.2	46.3	57.5
4,000	650	136.5	33.3	43.9	55.6
5,000	622	130.6	30.3	41.4	53.6
6,000	596	125.2	27.3	38.8	51.6
7,000	570	119.7	24.0	36.0	49.4
8,000	550	115.5	21.2	33.7	47.5
9,000	528	110.9	17.9	30.9	45.3
10,000	505	106.1	14.2	27.8	42.9

Table A.1.5.1.3(c) Physiological Effects of Inert Gas Agents

Agent	No Effect Level* (%)	Low Effect Level* (%)
IG-01	43	52
IG-100	43	52
IG-55	43	52
IG-541	43	52

*Based on physiological effects in humans in hypoxic atmospheres. These values are the functional equivalents of NOAEL and LOAEL values and correspond to 12 percent minimum oxygen for the no effect level and 10 percent minimum oxygen for the low effect level.

ASET value is initially determined to be equal to or exceed the RSET value, egress facilities should be modified so that the ASET value is less than the RSET value. Alternatively, an egress study involving the time recording of an actual egress simulation in the protected space is considered an acceptable means of verifying compliance with the maximum allowed exposure time limits.

A.1.5.1.5.1 The steps and safeguards necessary to prevent injury or death to personnel in areas whose atmospheres will be made hazardous by the discharge or thermal decomposition of clean agents can include the following:

- (1) Provision of adequate aiseways and routes of exit and procedures to keep them clear at all times.
- (2) Provision of emergency lighting and directional signs as necessary to ensure quick, safe evacuation.
- (3) Provision of alarms within such areas that will operate immediately upon detection of the fire.
- (4) Provision of only outward-swinging, self-closing doors at exits from hazardous areas and, where such doors are latched, provision of panic hardware.
- (5) Provision of continuous alarms at entrances to such areas until the atmosphere has been restored to normal.

- (6) Provision of warning and instruction signs at entrances to and inside such areas. These signs should inform persons in or entering the protected area that a clean agent system is installed and should contain additional instructions pertinent to the conditions of the hazard.
- (7) Provision for the prompt discovery and rescue of persons rendered unconscious in such areas. This should be accomplished by having such areas searched immediately by trained personnel equipped with proper breathing equipment. Self-contained breathing equipment and personnel trained in its use and in rescue practices, including artificial respiration, should be readily available.
- (8) Provision of instruction and drills for all personnel within or in the vicinity of such areas, including maintenance or construction people who could be brought into the area, to ensure their correct action when a clean agent system operates.
- (9) Provision of means for prompt ventilation of such areas. Forced ventilation will often be necessary. Care should be taken to readily dissipate hazardous atmospheres and not merely move them to another location.
- (10) Prohibition against smoking by persons until the atmosphere has been determined to be free of the clean agent.
- (11) Provision of such other steps and safeguards that a careful study of each particular situation indicates is necessary to prevent injury or death.

A.1.5.1.5.2 A certain amount of leakage from a protected space to adjacent areas is anticipated during and following agent discharge. Consideration should be given to agent concentration (when above NOAEL), decomposition products, products of combustion, and relative size of adjacent spaces. Additional consideration should be given to exhaust paths when opening or venting the enclosure after a discharge.

A.1.5.1.5.4 Inert gases used to operate pre-discharge alarms include inert gas clean agents, nitrogen, and carbon dioxide.

A.1.5.2.4 Electrostatic charging of ungrounded conductors could occur during the discharge of liquefied gases. These conductors could discharge to other objects, causing an electric arc of sufficient energy to initiate an explosion.

While an attractive feature of these agents is their suitability for use in environments containing energized electrical equipment without damaging that equipment, in some instances the electrical equipment could be the source of ignition. In such cases, the energized equipment should be de-energized prior to or during agent discharge.

See NFPA 77.

A.1.6 Many factors impact the environmental acceptability of a fire suppression agent. Uncontrolled fires pose significant impact by themselves. All extinguishing agents should be used in ways that eliminate or minimize the potential environmental impact (see Table A.1.6). General guidelines to be followed to minimize this impact include the following:

- (1) Not performing unnecessary discharge testing
- (2) Considering the ozone depletion and global warming impact of the agent under consideration and weighing those impacts against the fire safety concerns
- (3) Recycling all agents where possible
- (4) Consulting the most recent environmental regulations on each agent

The unnecessary emission of clean extinguishing agents with non-zero ODP, non-zero GWP, or both should be avoided. All phases of design, installation, testing, and maintenance of systems using these agents should be performed with the goal of no emission into the environment.

GWP is a measure of how much a given mass of greenhouse gas is estimated to contribute to global warming. It is a relative scale that compares the gas in question to the same mass of carbon dioxide whose GWP is by convention equal to 1.

It is important to understand that the impact of a gas on climate change is a function of both the GWP of the gas and the amount of the gas emitted.

The ODP of an agent provides a relative comparison of the ability to react with ozone at altitudes within the stratosphere. ODP values are reported relative to the same mass CFC-11, which has an ODP equal to 1. When the environmental profile of a compound is considered, both the ODP and the GWP values should be considered to ensure that the agent selected complies with all local and regional regulations balanced with end user specifications. Good independent resources for environmental properties in terms of GWP and ODP of clean agent alternatives are available from the Montreal Protocol and the Intergovernmental Panel on Climate Change (IPCC).

▲ **A.1.8.1** It is generally believed that, because of the highly stable nature of the compounds that are derived from the families that include halogenated hydrocarbons and inert gases, incompatibility will not be a problem. These materials tend to behave in a similar fashion, and, as far as is known, the reactions that could occur as the result of the mixing of these materials within the container is not thought to be a real consideration with regard to their application to a fire protection hazard.

It clearly is not the intent of 1.8.1 to deal with compatibility of the agents with components of the extinguishing hardware nor to deal with the subject of storability or storage life of individual agents or mixtures of those agents. Each of these concerns is addressed elsewhere in this standard.

▲ **Table A.1.6 Potential Environmental Impacts**

Agent	GWP (IPCC 2013)	ODP
FIC-13I1	≤1	0*
FK-5-1-12	<1	0
HCFC Blend A	1500	0.048
HFC Blend B	1400	0
HCFC-124	527	0.022
HFC-125	3170	0
HFC-227ea	3350	0
HFC-23	12,400	0
HFC-236fa	8060	0
IG-01	0	0
IG-100	0	0
IG-541	0	0
IG-55	0	0

Note: GWP is reported over a 100-year integrated time horizon.

*Agent might have a non-zero ODP if released at altitudes high above ground level.

A.3.2.1 Approved. The National Fire Protection Association does not approve, inspect, or certify any installations, procedures, equipment, or materials; nor does it approve or evaluate testing laboratories. In determining the acceptability of installations, procedures, equipment, or materials, the authority having jurisdiction may base acceptance on compliance with NFPA or other appropriate standards. In the absence of such standards, said authority may require evidence of proper installation, procedure, or use. The authority having jurisdiction may also refer to the listings or labeling practices of an organization that is concerned with product evaluations and is thus in a position to determine compliance with appropriate standards for the current production of listed items.

A.3.2.2 Authority Having Jurisdiction (AHJ). The phrase “authority having jurisdiction,” or its acronym AHJ, is used in NFPA documents in a broad manner, since jurisdictions and approval agencies vary, as do their responsibilities. Where public safety is primary, the authority having jurisdiction may be a federal, state, local, or other regional department or individual such as a fire chief; fire marshal; chief of a fire prevention bureau, labor department, or health department; building official; electrical inspector; or others having statutory authority. For insurance purposes, an insurance inspection department, rating bureau, or other insurance company representative may be the authority having jurisdiction. In many circumstances, the property owner or his or her designated agent assumes the role of the authority having jurisdiction; at government installations, the commanding officer or departmental official may be the authority having jurisdiction.

A.3.2.3 Listed. The means for identifying listed equipment may vary for each organization concerned with product evaluation; some organizations do not recognize equipment as listed unless it is also labeled. The authority having jurisdiction should utilize the system employed by the listing organization to identify a listed product.

■ A.3.3.1 Abort Switch. The effect of an abort switch is typically a programmable configuration of the releasing panel, such that any of several modes of operation can be used. Typical options include the following:

- (1) Engaging the abort switch pauses the countdown for as long as the switch remains engaged. The countdown resumes when the switch is released.
- (2) Engaging the abort switch resets the timer to a predetermined value (e.g., the initial value or 30 seconds) and pauses the countdown for as long as the switch remains engaged. The countdown restarts when the switch is released.
- (3) Engaging the switch permits the timer to continue counting down until it reaches a predetermined value (e.g., 10 seconds), then it pauses for as long as the switch remains engaged. The countdown resumes from the predetermined value when the switch is released.

Where an abort switch is installed, the selected mode should be approved by the authority having jurisdiction. (See 4.3.5.3 and 7.6.14.)

■ A.3.3.7 Clean Agent. The word *agent* as used in this document means clean agent unless otherwise indicated.

A.3.3.10.1 Adjusted Minimum Design Concentration (AMDC). This term is also referred to as simply *design concentration* throughout this document. When determining the duration of

protection it is 85 percent of the AMDC that must be held for the duration of the retention time (see Section 5.6).

A.3.3.10.2 Final Design Concentration (FDC). The FDC is equal to or greater than the adjusted minimum design concentration.

A.3.3.15 Halocarbon Agent. Examples are hydrofluorocarbons (HFCs), hydrochlorofluorocarbons (HCFCs), perfluorocarbons (PFCs or FCs), fluoriodocarbons (FICs), and fluoroketones (FKs).

A.3.3.27 Normally Occupied Enclosure or Space. Areas considered not normally occupied include spaces occasionally visited by personnel, such as transformer bays, switch houses, pump rooms, vaults, engine test stands, cable trays, tunnels, microwave relay stations, flammable liquid storage areas, and enclosed energy systems.

A.4.1.1.2 An **additional** complement of charged cylinders (connected reserve) manifolded and piped to feed into the automatic system should be considered on all installations. The reserve supply is normally actuated by manual operation of the main/reserve switch on either electrically operated or pneumatically operated systems. A connected reserve is desirable for the following reasons:

- (1) It provides protection should a reflash occur.
- (2) It provides reliability should the main bank malfunction.
- (3) It provides protection during impaired protection when main tanks are being replaced.
- (4) It provides protection of other hazards if selector valves are involved and multiple hazards are protected by the same set of cylinders.

If a full complement of charged cylinders cannot be obtained or if the empty cylinder cannot be recharged, delivered, and reinstalled within 24 hours, a third complement of fully charged, nonconnected spare cylinders should be considered and made available on the premises for emergency use. The need for spare cylinders could depend on whether the hazard is under the protection of automatic sprinklers.

A.4.1.2 The normal and accepted procedures for making these quality measurements are provided in international standards (e.g., ASTM, Air-conditioning Heating and Refrigeration Institute) or by the chemical manufacturer. Refer to the *Code of Practice for Use of Recycled Halogenated Clean Agents* for additional information.

A.4.1.3.2 Storage containers should not be exposed to a fire in a manner likely to impair system performance.

A.4.1.4.1 Containers used for agent storage should be fit for the purpose. Materials of construction of the container, closures, gaskets, and other components should be compatible with the agent and designed for the anticipated pressures. Each container is equipped with a pressure relief device to protect against excessive pressure conditions.

The variations in vapor pressure with temperature for the various clean agents are shown in Figure A.4.1.4.1(a) through Figure A.4.1.4.1(m).

For halocarbon clean agents, the pressure in the container is significantly affected by fill density and temperature. At elevated temperatures, the rate of increase in pressure is very sensitive to fill density. If the maximum fill density is exceeded, the pressure will increase rapidly with temperature increase and

present a hazard to personnel and property. Therefore, it is important that the maximum fill density limit specified for each liquefied clean agent not be exceeded. Adherence to the limits for fill density and pressurization levels specified in Table A.4.1.4.1 should prevent excessively high pressures from occurring if the agent container is exposed to elevated temperatures. Adherence to the limits will also minimize the possibility of an inadvertent discharge of agent through the pressure relief device. The manufacturer should be consulted for superpressurization levels other than those shown in Table A.4.1.4.1.

With the exception of inert gas-type systems, all the other clean agents are classified as liquefied compressed gases at 70°F (21°C). For these agents, the pressure in the container is significantly affected by fill density and temperature. At elevated temperatures, the rate of increase in pressure is very sensitive to fill density. If the maximum fill density is exceeded, the pressure will increase rapidly with temperature increase and present a hazard to personnel and property. Therefore, it is important that the maximum fill density limit specified for each liquefied clean agent not be exceeded. Adherence to the limits for fill density and pressurization levels specified in Table A.4.1.4.1 should prevent excessively high pressures from occurring if the agent container is exposed to elevated temperatures. Adherence to the limits will also minimize the possibility of an

inadvertent discharge of agent through the pressure relief device. The manufacturer should be consulted for superpressurization levels other than those shown in Table A.4.1.4.1.

A.4.1.4.2 Although it is not a requirement of 4.1.4.2, all new and existing halocarbon agent storage containers should be affixed with a label advising the user that the product in question can be returned for recovery and recycling to a qualified recycler when the halocarbon agent is no longer needed. The qualified recycler can be a halocarbon agent manufacturer, a fire equipment manufacturer, a fire equipment distributor or installer, or an independent commercial venture. It is not the intent to set down specific requirements but to indicate the factors that need to be taken into consideration with regard to recycling and reclamation of the halocarbon agent products, once facilities are available. As more information becomes available, more definitive requirements can be set forth in this section regarding quality, efficiency, recovery, and qualifications and certifications of facilities recycling halocarbon agents. Currently, no such facilities exist that would apply to the halocarbon agents covered by this document.

Inert gas agents need not be collected or recycled.

A.4.1.4.5(2) Inert gas agents are single-phase gases in storage and at all times during discharge.

▲ **Table A.4.1.4.1 Storage Container Characteristics**

Extinguishing Agent	Maximum Fill Density for Conditions Listed (lb/ft ³)	Minimum Container Design Level Working Pressure (Gauge) (psi)	Total Gauge Pressure Level at 70°F (psi)
FK-5-1-12	90	500	360
HCFC Blend A	56.2	500	360
HCFC-124	71	240	195
HFC-125	58	320	166.4 ^a
HFC-227ea	72	500	360
HFC-23	54	1800	608.9 ^a
FIC-1311	104.7	500	360
IG-01	N/A	2120	2370
IG-100 (300)	N/A	3600	4061
IG-100 (240)	N/A	2879	3236
IG-100 (180)	N/A	2161	2404
IG-541	N/A	2015	2175
IG-541 (200)	N/A	2746	2900
IG-55 (2222)	N/A	2057	2222 ^b
IG-55 (2962)	N/A	2743	2962 ^c
IG-55 (4443)	N/A	4114	4443 ^d
HFC Blend B	58	400	195 ^e

For SI units, 1 lb/ft³ = 16.018 kg/m³; 1 psi = 6895 Pa; °C = (°F – 32)/1.8.

Notes:

(1) The maximum fill density requirement is not applicable for IG-541. Cylinders for IG-541 are DOT 3A or 3AA and are stamped 2015 or greater.

(2) Total pressure level at 70°F (21°C) is calculated from the following filling conditions:

IG-100 (300): 4351 psi (30.0 MPa) and 95°F (35°C)

IG-100 (240): 3460 psi (23.9 MPa) and 95°F (35°C)

IG-100 (180): 2560 psi (17.7 MPa) and 95°F (35°C)

IG-55 (2222): 2175 psi (15 MPa) and 59°F (15°C)

IG-55 (2962): 2901 psi (20 MPa) and 59°F (15°C)

IG-55 (4443): 4352 psi (30 MPa) and 59°F (15°C)

^a Vapor pressure for HFC-23 and HFC-125.

^b Cylinders for IG-55 are stamped 2060.

^c Cylinders for IG-55 are DOT 3A or 3AA stamped 2750 or greater.

^d Cylinders for IG-55 are DOT 3A or 3AA stamped 4120 or greater.

^e Vapor pressure of agent.

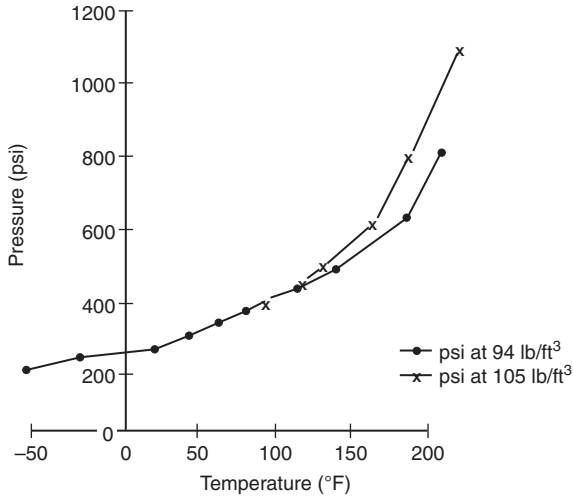

Note: CF3I pressure versus temperature at 94 lb/ft³ and 105 lb/ft³

(1) U.S.

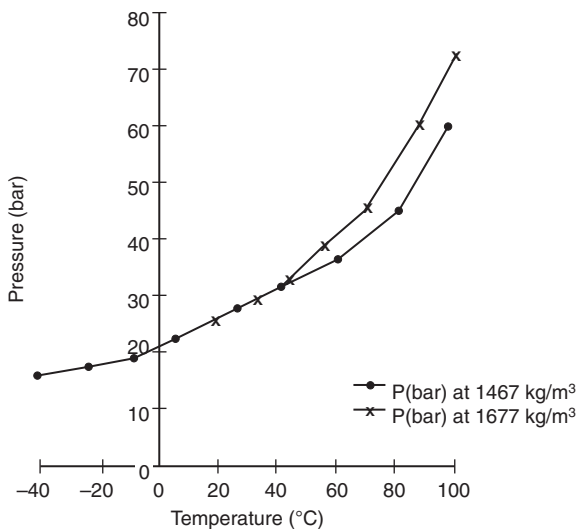

Note: CF3I pressure versus temperature at 1467 kg/m³ and 1677 kg/m³

(2) SI

FIGURE A.4.1.4.1(a) Isometric Diagram of FIC-131I.

A.4.1.4.6 The use of environmental controls should be considered when the storage location for clean agent system containers is subject to conditions outside of the storage temperature limits stated in the listed manual for the clean agent system.

A.4.2.1 Piping should be installed in accordance with good commercial practice. Care should be taken to avoid possible restrictions due to foreign matter, faulty fabrication, or improper installation.

The piping system should be securely supported with due allowance for agent thrust forces and thermal expansion and contraction and should not be subjected to mechanical, chemical, vibration, or other damage. ASME B31.1 should be consul-

ted for guidance on this matter. Where explosions are likely, the piping should be attached to supports that are least likely to be displaced.

A.4.2.1.1 Paragraph 4.2.1.1 requires that “the thickness of the piping shall be calculated in accordance with ASME B31.1.” To comply with this requirement, the guidelines found in the *FSSA Pipe Design Guide for Use with Special Hazard Fire Suppression Systems* should be followed. The *FSSA Pipe Design Guide for Use with Special Hazard Fire Suppression Systems* provides guidance on how to apply ASME B31.1 in a uniform and consistent manner in the selection of acceptable types of pipe and tubing used in special hazard fire suppression systems. ASME B31.1 allows the pressure to exceed the maximum design pressure, provided it is for short operating periods. Clean agent piping systems are not subjected to continuous pressurization. When discharge times are less than 60 minutes in duration, NFPA 2001 allows the yield stress factors (SE) published in ASME B31.1 to be increased by 20 percent when calculating the pipe thickness.

A.4.2.1.7 Design of closed sections of pipe should follow the guidelines in Section 5 of the *FSSA Pipe Design Guide for Use with Special Hazard Fire Suppression Systems*.

Δ A.4.2.2.2 Fittings that are acceptable for use in clean agent systems can be found in Table A.4.2.2.2(a) and Table A.4.2.2.2(b). The fittings shown in these tables are based on use in open-ended piping systems. For fittings used in closed sections of pipe, Sections 4 and 7 of the *FSSA Pipe Design Guide for Use with Special Hazard Fire Suppression Systems* should be consulted.

Pressure-temperature ratings have been established for certain types of fittings. A list of ANSI standards covering the different types of fittings is given in Table 126.1 of ASME B31.1. Where fittings not covered by one of these standards are used, the design recommendations of the manufacturer of the fittings should not be exceeded.

N A.4.2.3 The *FSSA Pipe Design Guide for Use with Special Hazard Fire Suppression Systems* provides guidance on pipe hangers and supports, following established industry practices. Additional guidance based on “best industry standard practice” is found in ANSI/MSS SP-58 for locations where seismic qualification is not required or in MSS SP-127 for locations where seismic qualification is required.

A.4.2.4.3 Some of the new clean agents might not be compatible with the elastomers used in Halon 1301 system valves. Before charging a system container with some of the clean agents, it could be necessary to disassemble the discharge valve and completely replace the O-rings and other sealing surfaces with components that will not react to that agent. It is important that this evaluation has been completed and that the change results in the valve, container, and system complying with the appropriate listings or approvals.

A.4.2.5.5 The impingement of the extinguishing agent during a discharge can adversely affect the development of a homogeneous concentration throughout the protected space. The manufacturer should be consulted for acceptable distances for the discharge nozzles from obstructions such as cable trays, hot aisle/cold aisle containment structures, duct work, and so forth. Where minimum distances cannot be achieved, the manufacturer should be consulted to obtain agent loss calculations for the specific nozzle locations, and the necessary compensating quantity of agent should be added.

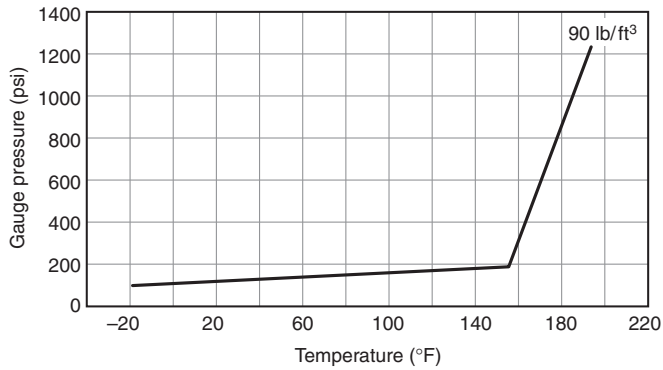

(1) For 150 psi containers

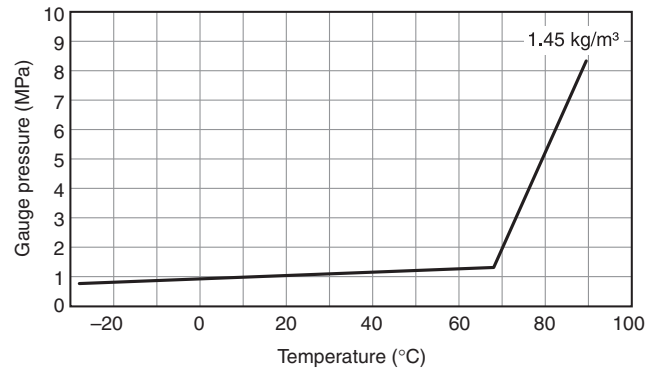

(2) For 1.0 MPa containers

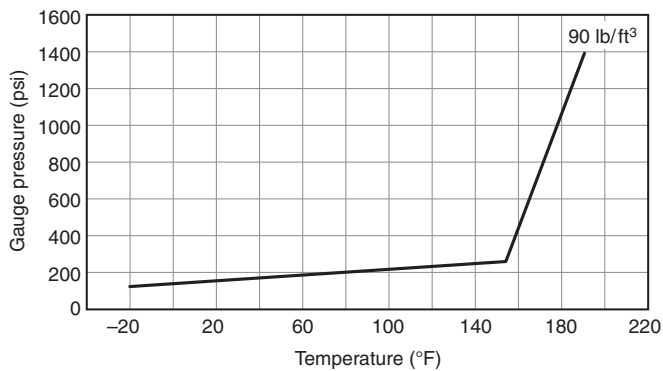

(3) For 195 psi containers

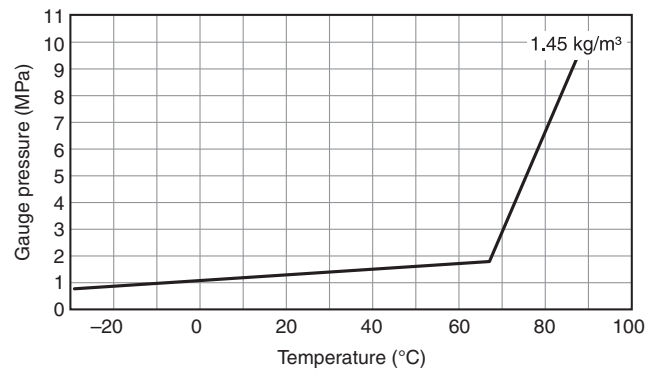

(4) For 1.3 MPa containers

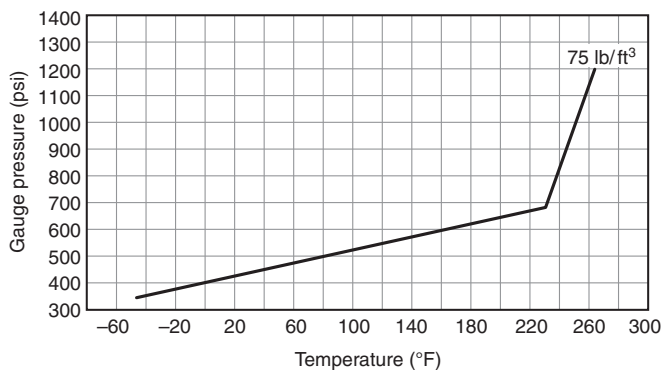

(5) For 500 psi containers

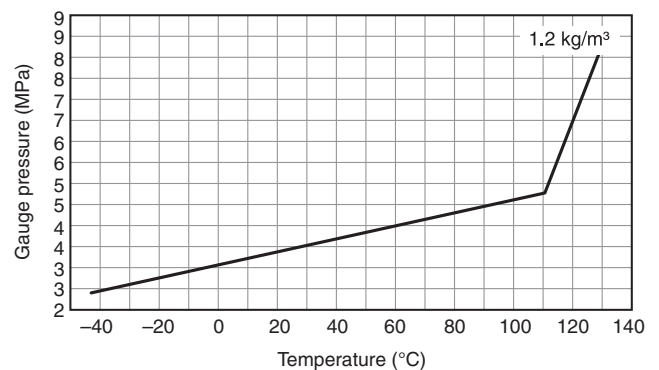

(6) For 3.4 MPa containers

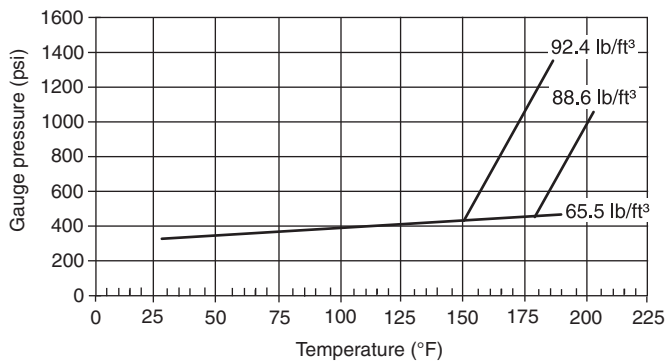

(7) To 360 psi at 70°F

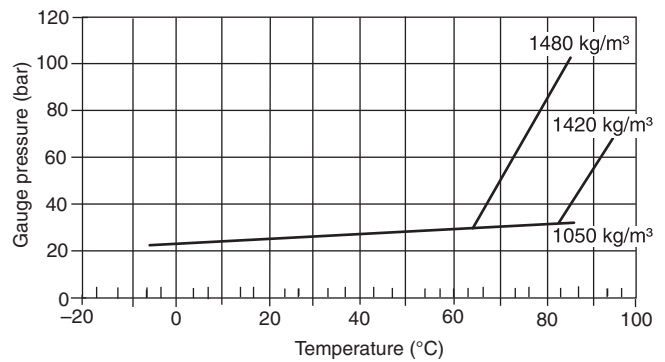

(8) To 25 bar at 20°C

FIGURE A.4.1.4.1(b) Isometric Diagram of FK-5-1-12.

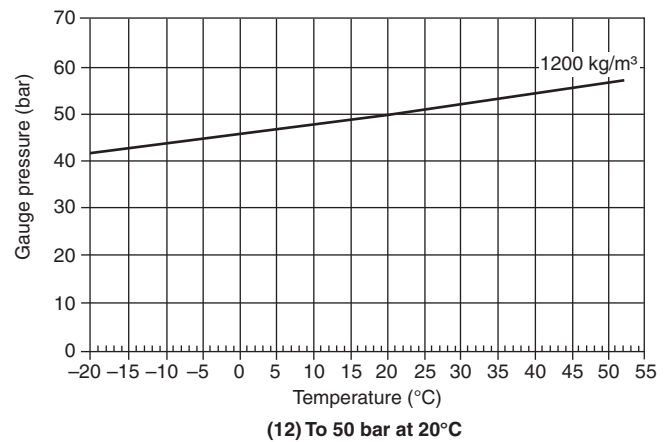
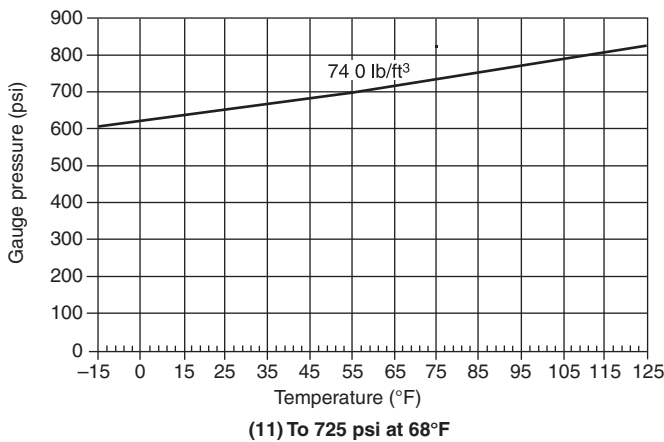
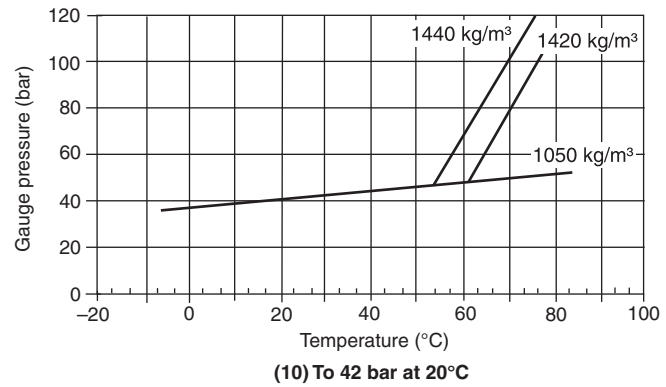
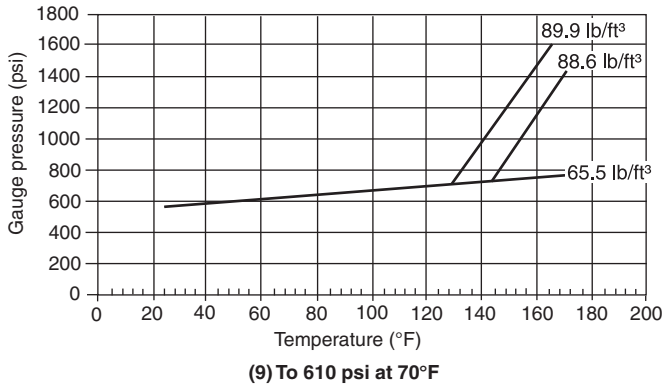

FIGURE A.4.1.4.1(b) Continued

A.4.3.1.1 The FSSA *Application Guide Detection & Control for Fire Suppression Systems* offers the designer information of the various types of detection and control equipment.

N A.4.3.1.1.2 Any output or relay (dry contact output) from the protected premises building fire alarm panel or another detection system not listed with the specific clean agent suppression system releasing device should not be used to directly release the system.

N A.4.3.1.3 Paragraph 4.3.1.3 does not preclude the use of listed wireless initiating devices. The use of raceways is intended to protect against physical damage to circuit wiring.

A.4.3.2.1 The detection system selection process should evaluate the ambient environmental condition in determining the appropriate device and sensitivity in order to prevent unwanted discharges while still providing the necessary earliest actuation. In high air flow environments, air-sampling detection devices should be considered.

Detectors installed at the maximum spacing as listed or approved for fire alarm use can result in excessive delay in agent release, especially where more than one detection device is required to be in alarm before automatic actuation results.

Where there is a risk of a flammable atmosphere being formed, the spacing and siting of flammable vapor detectors should be carefully considered to avoid excessive delay in agent release.

A.4.3.3.5.1 A discharge pressure switch can serve to initiate electrical functions that normally occur upon system actuation, such as shutdown functions and control panel actuation.

A.4.3.4.2 *NFPA 72*, 14.2.6.4, requires that “Suppression systems shall be secured from inadvertent actuation, including disconnection of releasing solenoids or electric actuators, closing of valves, other actions, or combinations thereof, for the specific system, for the duration of the fire alarm system testing.”

Clean agent systems generally have a device attached to one or more agent storage container discharge valves that, upon signal from the fire system releasing control unit, causes the discharge valve(s) to operate to release the agent. The device is referred to as an electric actuator. These actuators are typically either a solenoid operated device or a squib operated device.

During system maintenance, it is a common procedure to remove the solenoid operated actuators from the agent storage container discharge valve to prevent accidental discharge of the system and permit functional testing of the actuator. Some systems that incorporate selector valves also have electric actuators attached to the selector valves to control their operation by electrical signal from the control panel. These electric actuators might also need to be routinely removed from their selector valves during maintenance.

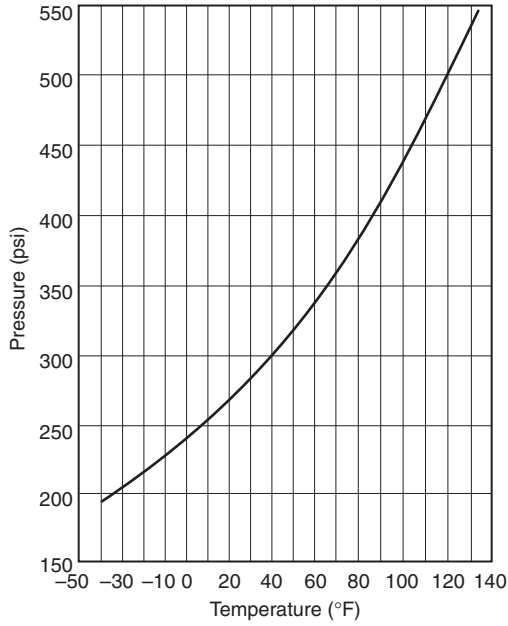

(1) Pressurized with nitrogen to 360 psi at 70°C

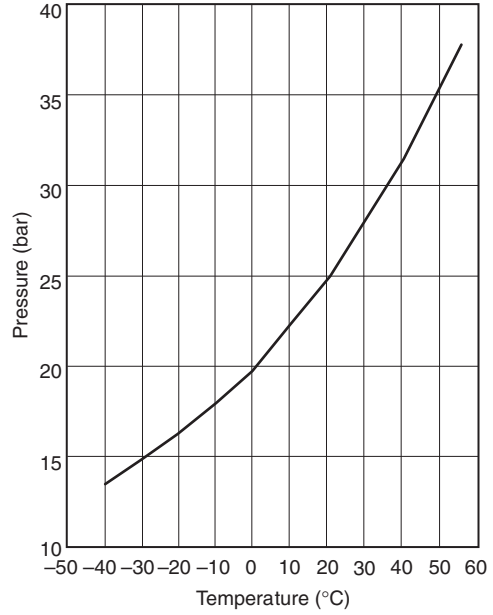

(2) Pressurized with nitrogen to 25 bar at 20°C

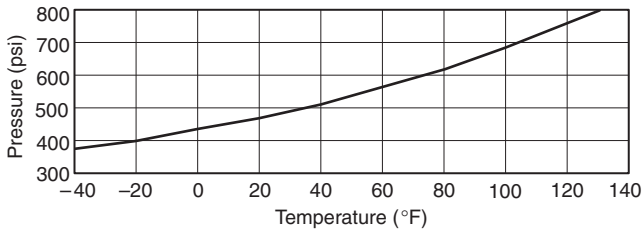

(3) Pressurized with nitrogen to 600 psi at 70°F for fill densities of 31.2 to 56.2 lb/ft³

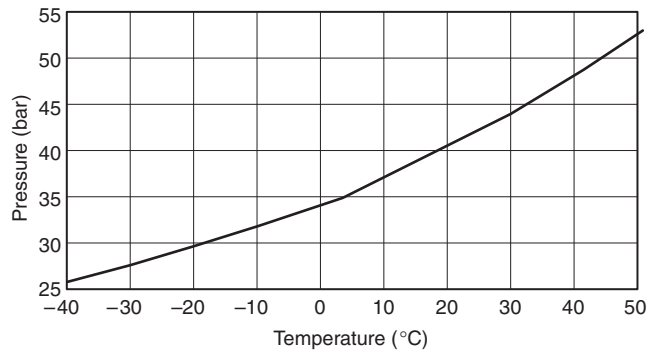

(4) Pressurized with nitrogen to 40 bar at 20°C for fill densities of 0.5 to 0.9 kg/m³

FIGURE A.4.1.4.1(c) Isometric Diagram of HCFC Blend A.

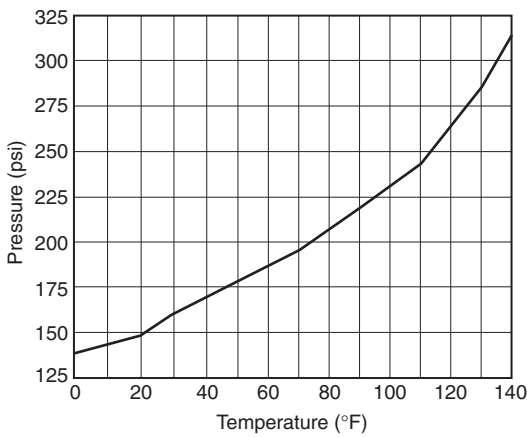

(1) Pressurized to 195 psi at 70°F and a loading density of 71.17 lb/ft³

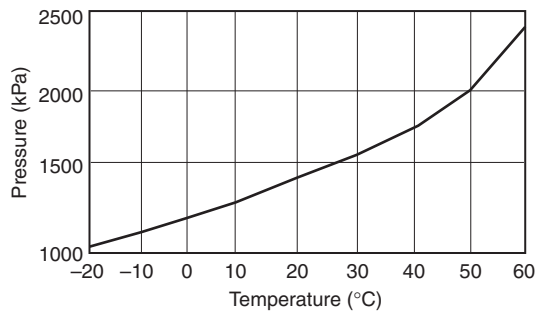

(2) Pressurized to 1340 kPa at 21°C and a loading density of 1140 kg/m³

FIGURE A.4.1.4.1(d) Isometric Diagram of HCFC-124 Pressurized with Nitrogen.

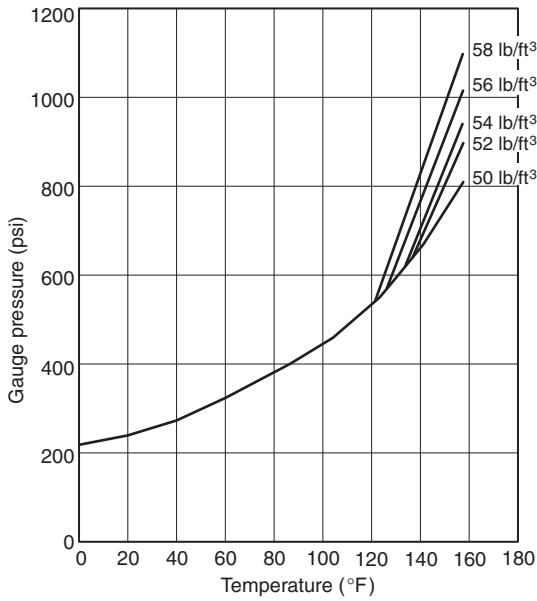

(1) Pressurized to 360 psi at 72°F

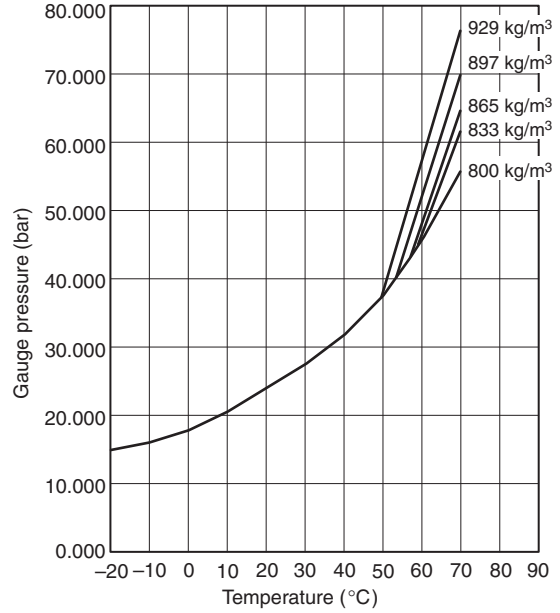

(2) Pressurized to 25 bar (gauge) at 22°C

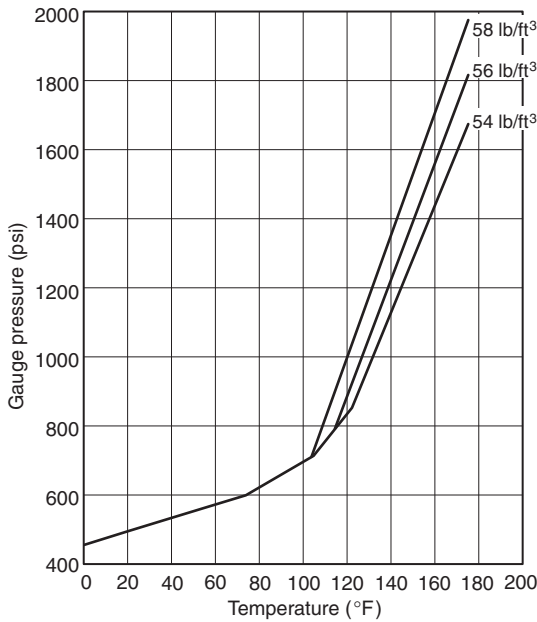

(3) Pressurized to 600 psi at 72°F

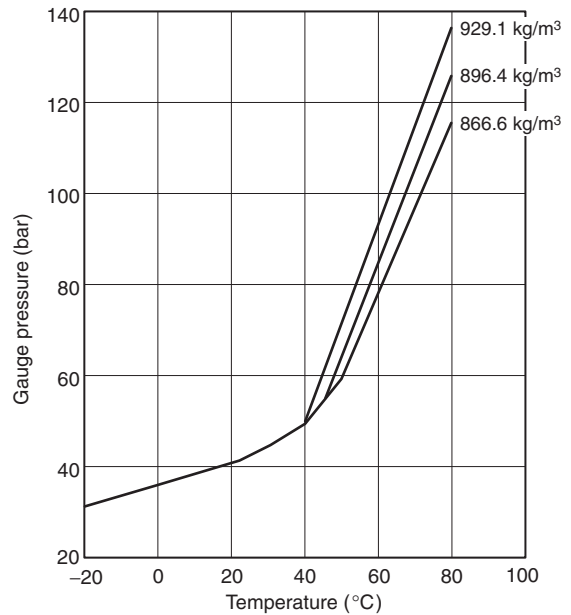

(4) Pressurized to 41 bar (gauge) at 22°C

FIGURE A.4.1.4.1(e) Isometric Diagram of HFC-125 Pressurized with Nitrogen.

Since the electrical connection between the solenoid and the system control panel is not broken by this maintenance procedure, special provision is required to provide an indication of system impairment at the releasing control panel when the electric actuator is physically removed from the valve it controls. There have been numerous reports of systems inadvertently left disabled after maintenance because the technician failed to reinstall the actuator on its valve. Fortunately in all reported cases, the impairment was discovered before the

system was required to operate, and only successful extinguishments have been reported — no failures to operate under fire conditions have come to the attention of the technical committee responsible for this standard.

Squib actuators are covered by this requirement only if the manufacturer’s maintenance instruction requires physical removal of the squib operated device from the valve it controls.

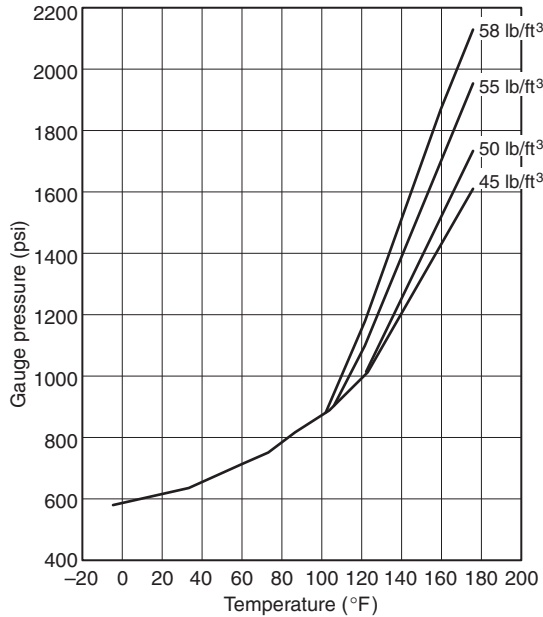

(5) Pressurized to 750 psi at 72°F

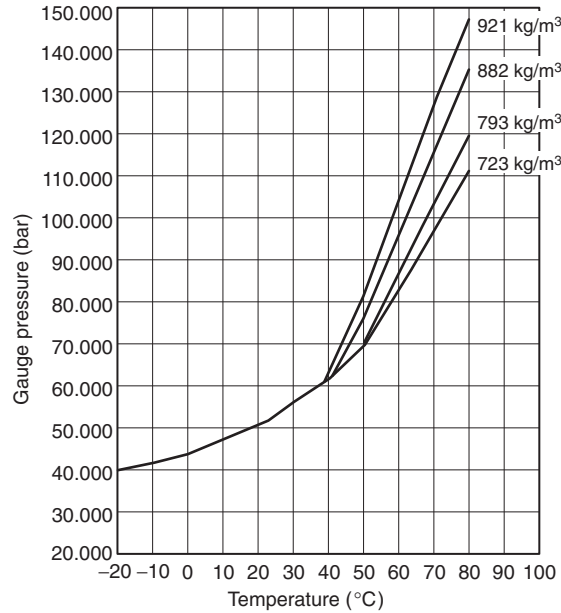

(6) Pressurized to 52 bar (gauge) at 22°C

FIGURE A.4.1.4.1(e) Continued

With the evolution of technology, cost effective means to monitor the placement of actuators can be developed. Because of the time required to develop hardware and to obtain listings and approvals for the hardware, the effective date for this provision of the standard is January 1, 2016.

A.4.3.5.3 A telephone should be located near the abort switch.

A.4.3.5.6.1 Hazards associated with fast growth fires would include, but not be limited to, flammable liquid storage or transfer areas and aerosol filling areas.

A.4.3.6 Accidental discharge can be a significant factor in unwanted clean agent emissions. Equipment lockout or service disconnects can be instrumental in preventing false discharges when the clean agent system is being tested or serviced. In addition, servicing of air-conditioning systems with the release of refrigerant aerosols, soldering, or turning electric plenum heaters on for the first time after a long period of idleness could trip the clean agent system. Where used, an equipment disconnect switch should be of the keyed-access type if external to the control panel, or it can be of the toggle type if within the locked control panel. Either type should annunciate at the panel when in the out-of-service mode. Written procedures should be established for taking the clean agent system out of service. Care should be taken to thoroughly evaluate and correct any factors that could result in unwanted discharges.

A.5.1.2.2(28) "Specified enclosure pressure limit" is a value determined or estimated with confidence to be less than the enclosure pressure strength. It is not intended to necessarily be the same as the "enclosure pressure strength" which would be determined by a structural engineering analysis.

Guidance to determine "pressure relief vent area" can be found in the FSSA *Application Guide to Estimating Enclosure Pressure & Pressure Relief Vent Area for Use with Clean Agent Fire Extinguishing Systems*. That guide can assist the designer in accurately determining the required information for inclusion on the working plans.

A.5.2 The two types of system flow calculations are liquefied compressed gas flow calculations and inert gas flow calculations.

Liquefied compressed gas flow calculations. Analyzing the behavior of two-phase agents in pipelines is a complex process with numerous methods. Two calculation methods are commonly used by fire protection professionals. The first is based on modifications to the HFLOW Method (DiNunno et al., 1995), completed in 1994, and the other is based on enhancement to the work of Hesson (Hesson, 1953) in 1953. Only those calculation methods that have been listed or approved should be used for design purposes.

The modified HFLOW calculation method is based on major modifications by Elliot et al. (1984) of a calculation method called HFLOW, developed by the Jet Propulsion Laboratory. The revised method is capable of predicting the two-phase flow characteristics of clean agents based on their thermodynamic properties. This method can calculate the flow characteristics of fire suppression agents across the wide range of real engineering systems in reasonable time scales.

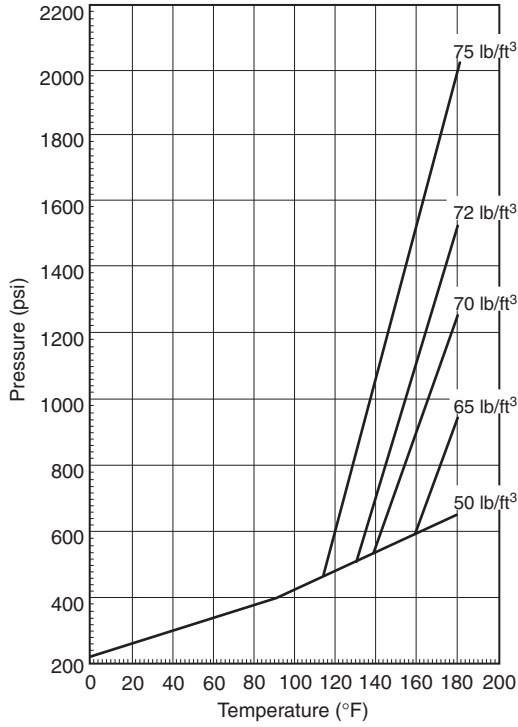

(1) Pressurized to 360 psi at 70°F

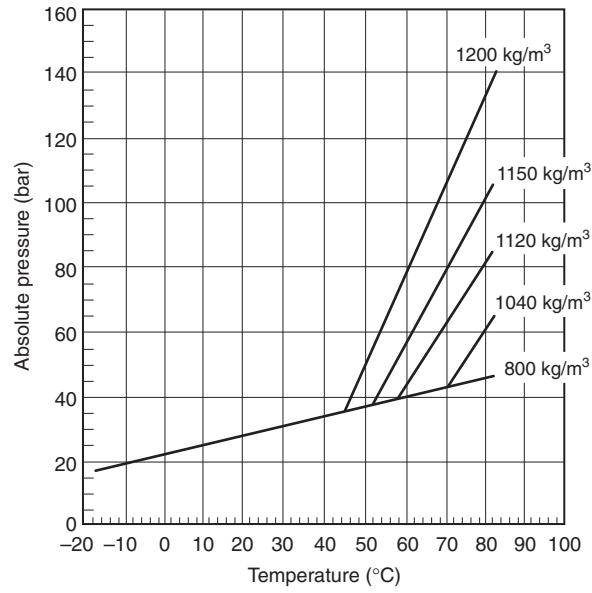

(2) Pressurized to 25 bar at 21°C

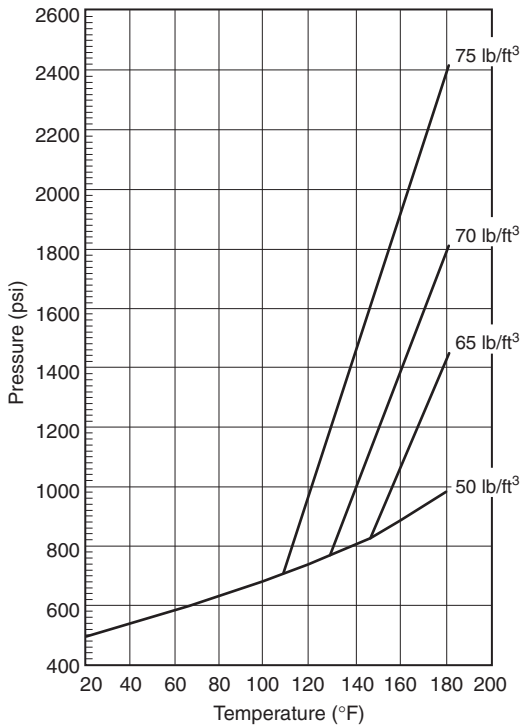

(3) Pressurized to 600 psi at 70°F

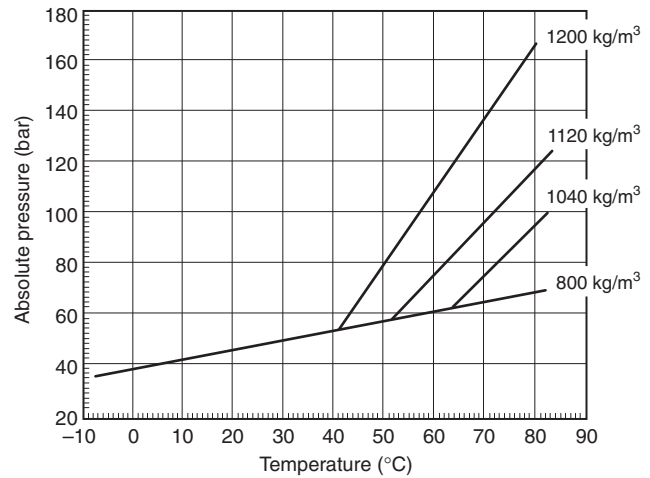

(4) Pressurized to 40 bar at 21°C

FIGURE A.4.1.4.1(f) Isometric Diagram of HCFC-227ea Pressurized with Nitrogen.

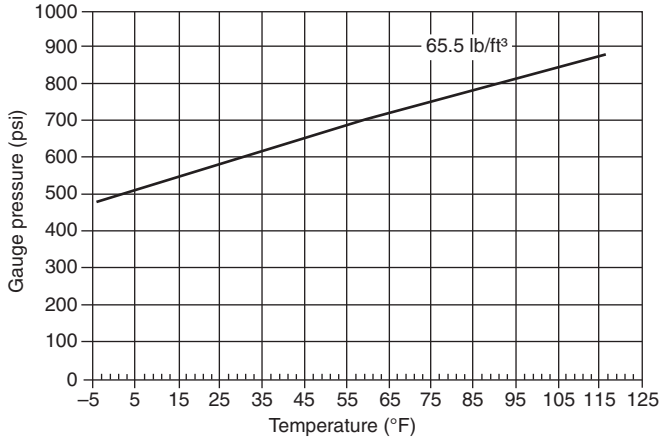

(5) HFC-227ea pressurized to 725 psi at 68°F

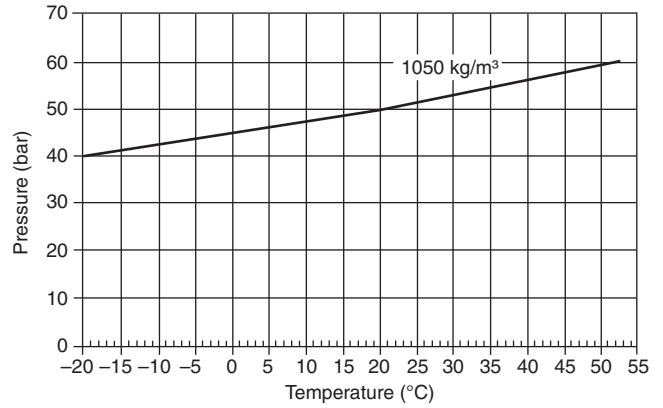

(6) HFC-227ea pressurized to 50 bar at 20°C

FIGURE A.4.1.4.1(f) Continued

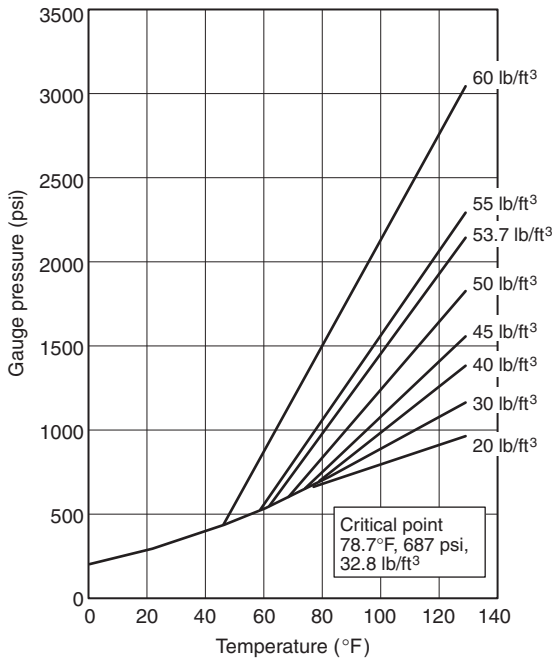

(1) Self-pressurized at 608.9 psi at 70°F

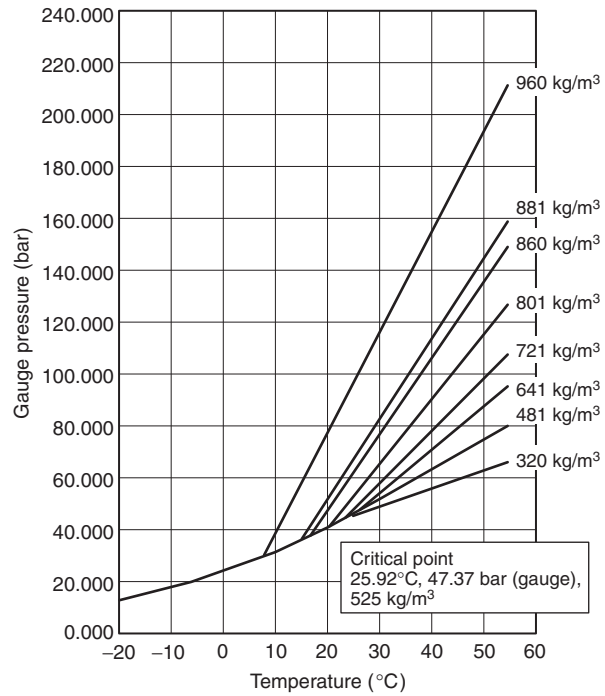

(2) Self-pressurized 42 bar at 21°C

FIGURE A.4.1.4.1(g) Isometric Design of HFC-23.

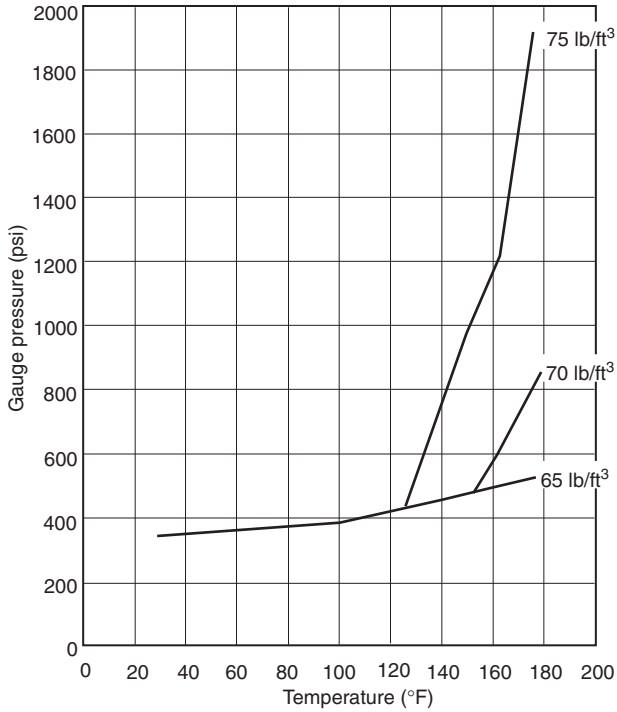

(1) Pressurized to 360 psi at 72°F

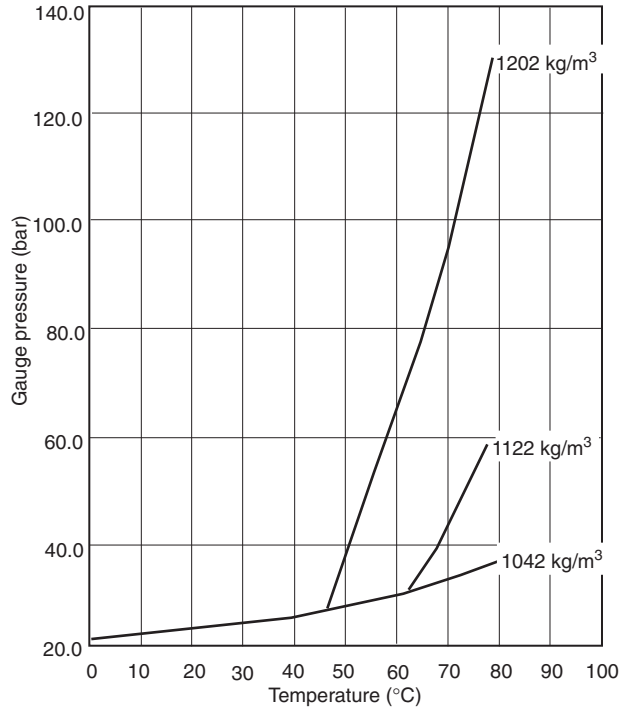

(2) Pressurized to 24.82 bar (gauge) at 22°C

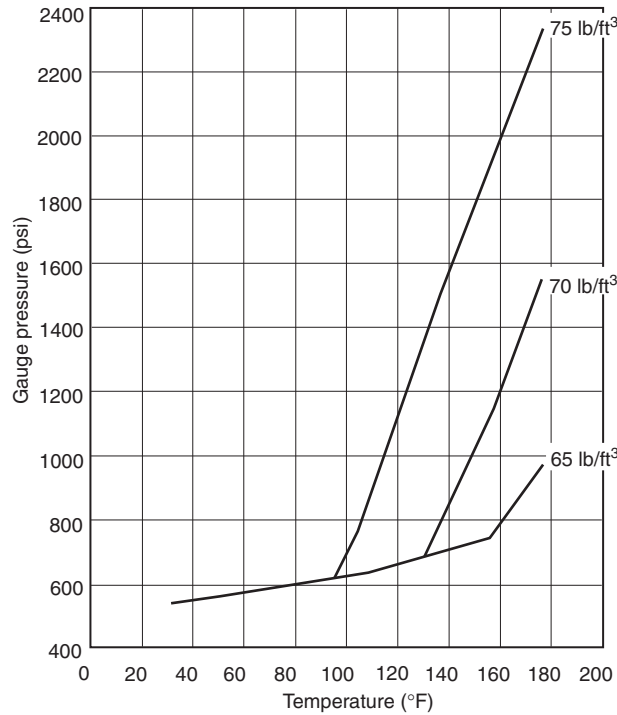

(3) Pressurized to 600 psi at 72°F

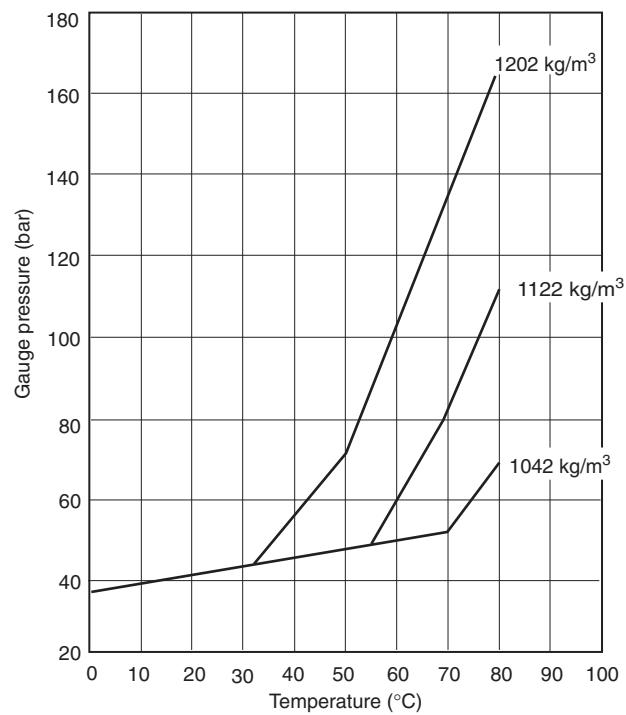

(4) Pressurized to 41.4 bar (gauge) at 22°C

FIGURE A.4.1.4.1(h) Isometric Diagram of HCFC-236fa Pressurized with Nitrogen.

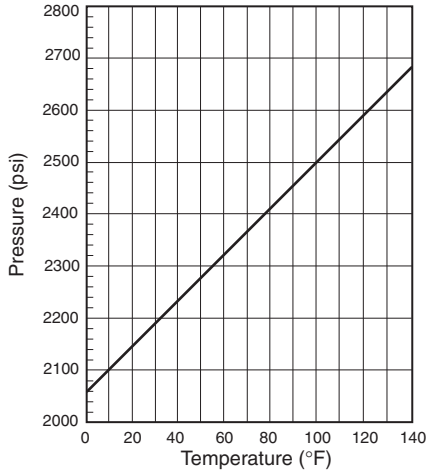

(1) Pressurized to 2370 psi at 70°F

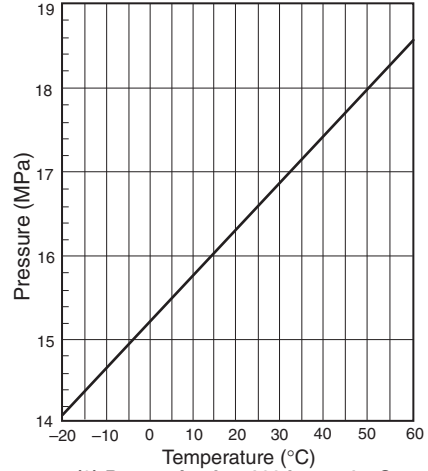

(2) Pressurized to 160 bar at 15°C

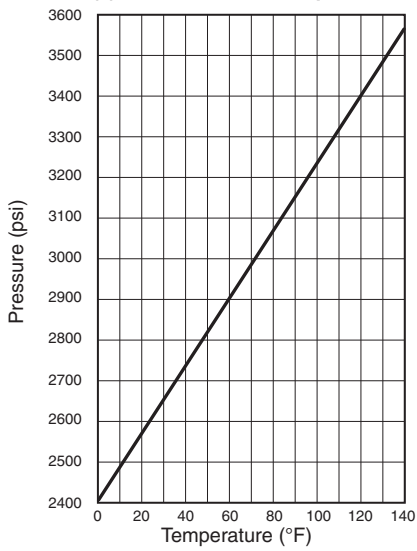

(3) Pressurized to 2894 psi at 70°F

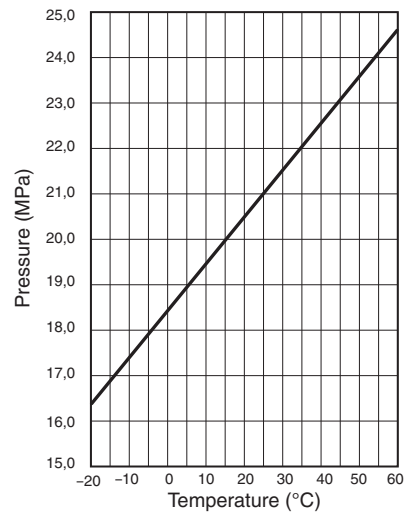

(4) Pressurized to 20.0 MPa at 15°C

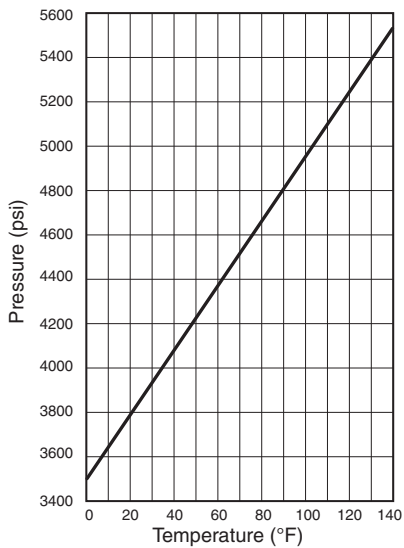

(5) Pressurized to 4510 psi at 70°F

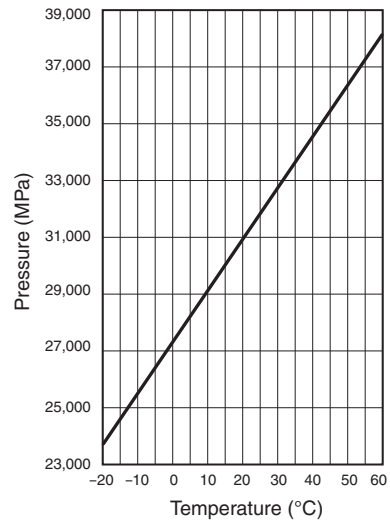

(6) Pressurized to 30.0 MPa at 15°C

FIGURE A.4.1.4.1(i) Isometric Diagram of IG-01.

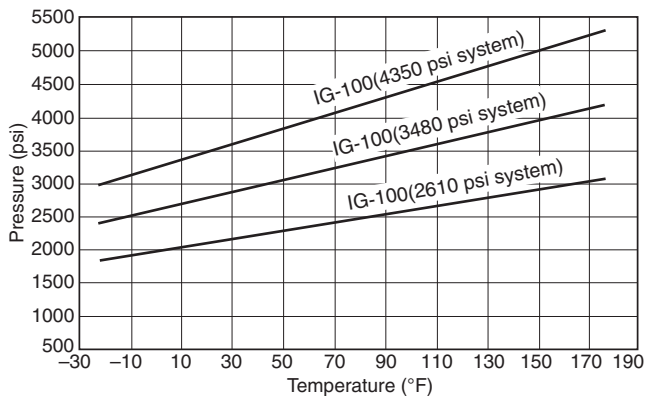

(1) 2610 psi, 3480 psi, and 4350 psi systems

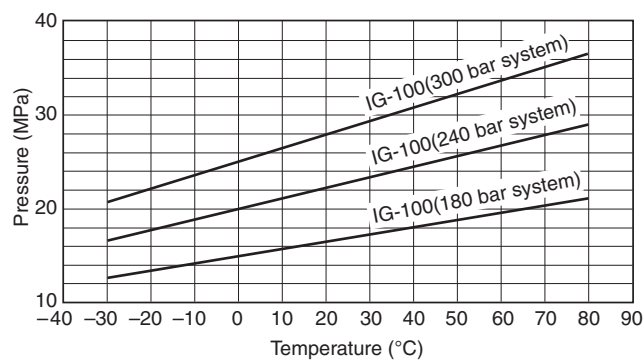

(2) 180 bar, 240 bar, and 300 bar systems

FIGURE A.4.1.4.1(j) Isometric Diagram of IG-100.

To simplify the methodology, the following basic assumptions are made:

- (1) The conditions in the cylinder (pressure, temperature, and composition) are solely functions of the initial conditions and the outage fraction (fraction of the initial charge mass having left the cylinder). This assumption effectively ignores the effect on the cylinder energy balance of the increased kinetic energy of the fluid leaving the cylinder.
- (2) Quasi-steady flow exists. The average flow rate over a small time interval step is equal to the flow rate that would exist if the cylinder conditions were held steady during that time step.
- (3) The heat transferred from the pipe walls to the flowing fluid is often insignificant.
- (4) The flow through the pipe network is homogeneous. Liquid flow and vapor flow through the piping are at the same velocity and evenly dispersed.

Calculation cannot be done without adequate manufacturer's hardware data. This data includes dip tube and manifold equivalent lengths and nozzle discharge coefficients.

Required input data include cylinder volume, valve and dip tube equivalent lengths, agent mass and temperature, pipe length and diameter, elevation, fittings, nozzle area, and discharge coefficients. Output data for each node (pipe, cylin-

der, or nozzle) include pressure, temperature, component fraction, phase distribution, mass flow rate, and velocity.

Due to its complexity, the HFLOW method does not lend itself to hand calculation.

The modified Hesson calculation methodology is a two-phase flow method first developed by Hesson for calculating pressure drop along a pipeline flowing carbon dioxide. Hesson adapted Bernoulli's equation for ease of use with compressible, two-phase flow. It was refined by H. V. Williamson and then Wysocki (1996) for use with Halon 1301 and other clean agents.

The two-phase flow method models the following three basic flow conditions for a liquefied compressed gas discharge from a storage container:

- (1) The initial transient discharge during which agent flows from the container and cools the pipe
- (2) A quasi-steady state flow during which the agent is assumed to maintain a constant enthalpy (adiabatic) condition with constant mass flow rate
- (3) The final transient discharge during which the two-phase flow is replaced by an essentially vapor discharge as the storage container empties

The pressure drop during the quasi-steady state flow is based on the work of Hesson (1953). The transient conditions are modeled using standard thermodynamics. During testing of the two-phase methodology with Halon 1301, mechanical separation of the liquid and vapor phases due to centripetal forces was observed. This effect has been noted for every liquefied compressed gas tested to date. The effect is not predicted by thermodynamics but was inferred from test data and confirmed using ultra-high speed photography (HT Research Institute, 1973). To accurately predict the quantity of agent discharge from each nozzle in a system, empirical corrections based on the degree of flow split, orientation of the tee junction, component fraction, and phase distribution are developed for the specific liquefied compressed gas.

The pressure drop calculation for the quasi-steady state flow using Hesson's adaption of Bernoulli's equation can be done by hand. The calculation of transient conditions and the calculation of mechanical separation effects at tees, and their effect on pressure drop and quantity of agent discharged from each nozzle in an unbalanced system, require many complex iterations. Manual calculation of these effects is not practical. Therefore, a listed and approved computer program must be used for a complete calculation.

Required input data include cylinder volume, agent mass and temperature, valve and dip tube equivalent lengths, pipe lengths, elevation changes, fittings, and pre-discharge pipe temperature. Most programs permit the user to specify either the required flow rate or the agent quantity for each nozzle or the "as-built" system condition. If flow rate or agent quantity is specified, the program will calculate the required pipe and nozzle diameters. If an "as-built" condition including pipe and nozzle diameters is specified, the program calculates system flow rates. In either case, pressure drop, discharge time, and quantity discharged from each nozzle are reported.

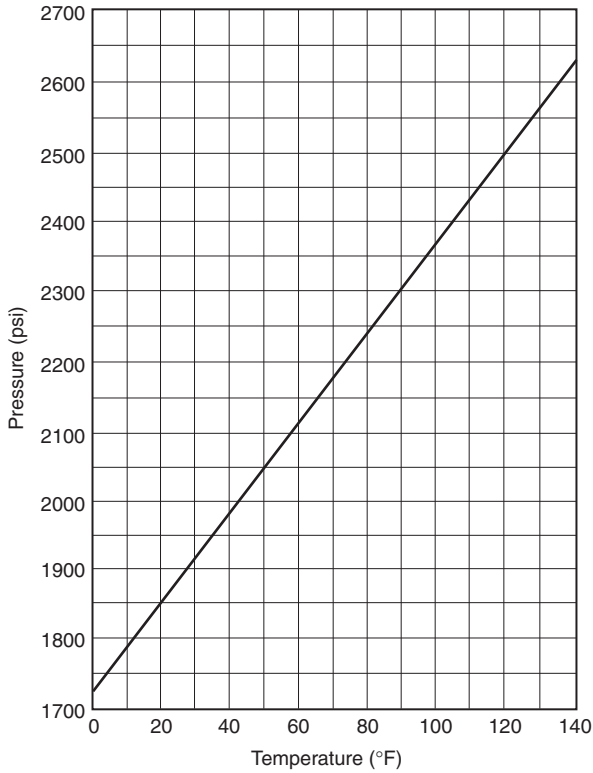

(1) Pressurized to 2175 psi at 70°F

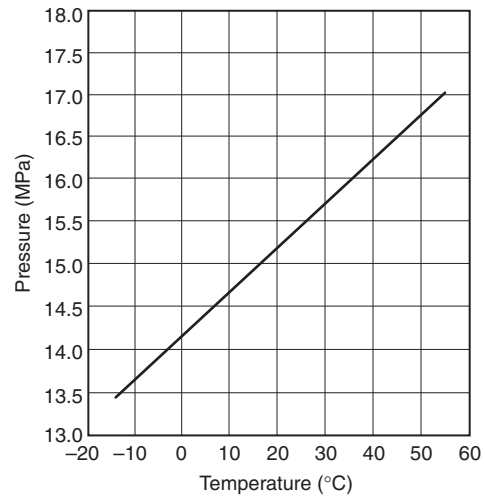

(2) Pressurized to 15 MPa at 21°C

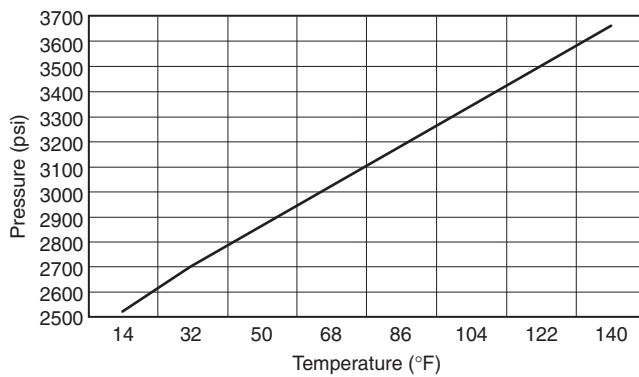

(3) Pressurized to 2900 psi at 59°F

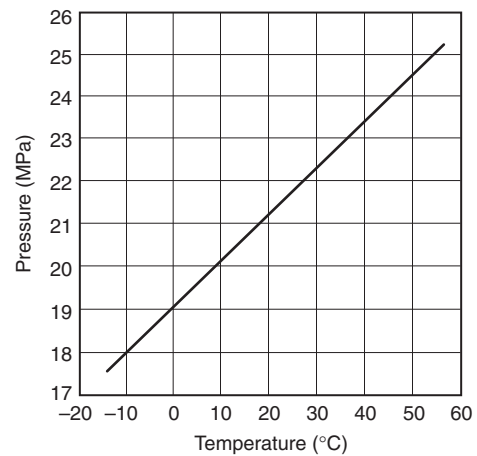

(4) Pressurized to 20 MPa at 15°C

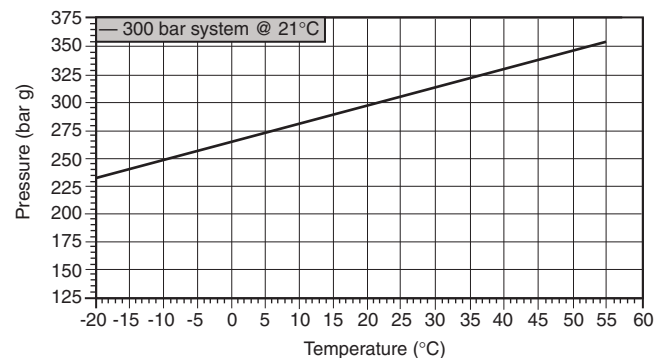
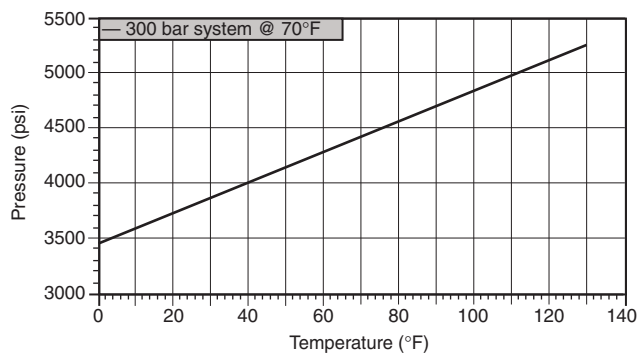

▲ FIGURE A.4.1.4.1(k) Isometric Diagram of IG-541.

Shaded text = Revisions. ▲ = Text deletions and figure/table revisions. • = Section deletions. N = New material.

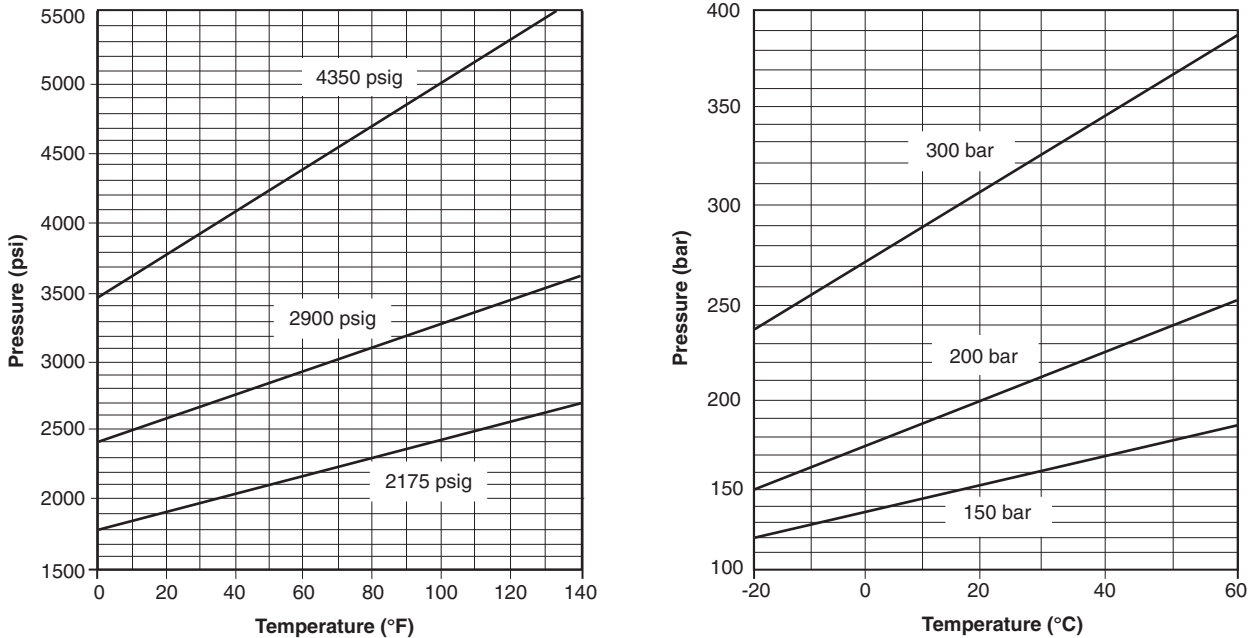

▲ FIGURE A.4.1.4.1(1) Isometric Diagram of IG-55 Filled at 59°F (15°C).

Inert gas flow calculations. Inert gases present a problem in single-phase compressible flow. Many fluid dynamics handbooks provide formulas for compressible gas flow that can be suitable for relatively simple pipe networks with short lengths of pipe. These formulas are inadequate to calculate systems using longer pipe lengths with complex configurations. Wysocki and Christensen (Wysocki et al., 1996) adapted the work of Hesson for use with single-phase compressible gases.

Inert gas discharge from a cylinder into a pipe and nozzle network involves the following three stages:

- (1) The initial transient phase as the gas flows into the pipe and fills the pipe up to the nozzles. There is a marked variation between the time at which various nozzles in an unbalanced pipe network begin discharging agent.
- (2) Full flow, during which all nozzles discharge agent. This is a dynamic condition during which the flow rates, agent temperatures, and pressure conditions constantly change.
- (3) Final transient condition, during which the storage container and pipeline empty. Complex changes in flow rates at the individual nozzles take place.

Flow in these systems is neither adiabatic nor isothermal (the two classical limits). The complexity of the calculation for large, unbalanced pipe networks necessitates use of a listed or approved computer program.

Regardless of the method used for flow calculations, certain limits are established during the listing and approval process for the flow calculation. Typical limits include the following:

- (1) Limit arc degree of split at tees
- (2) Limits on the orientation of tees
- (3) Limits on agent arrival time
- (4) Limits on agent “run out” or “end of liquid” time differences between nozzles

- (5) Minimum pressure limits
- (6) Minimum flow density limits
- (7) Maximum and minimum storage container fill density limits
- (8) Additional limits specific to the flow calculation program

The results of the calculation must be checked to verify that limits have not been exceeded. Computerized calculations generally report warning or error messages if the system falls outside program limits.

A.5.2.1 A listed or approved calculation method should predict agent mass discharged per nozzle, average nozzle pressure, and system discharge time within the following limits of accuracy:

- (1) The mass of agent predicted to discharge from a nozzle by the flow calculation method should agree with mass of agent measured from the nozzle by ± 10 percent of the predicted value. A standard deviation of the percentage differences between measured and predicted nozzle agent quantities, relative to zero, should not be greater than 5 percent.
- (2) The system discharge time predicted by the flow calculation method should agree with the actual system discharge time value or by ± 1 second for halocarbon systems or ± 10 seconds for inert gas systems, whichever is greater.
- (3) The average nozzle pressures predicted by the flow calculation method should agree with the actual nozzle pressures by ± 10 percent of the predicted value.
- (4) The nozzle pressure should not fall below the minimum or above the maximum nozzle pressure required for the nozzle to uniformly distribute the agent throughout the volume that the nozzle’s discharge is to protect.

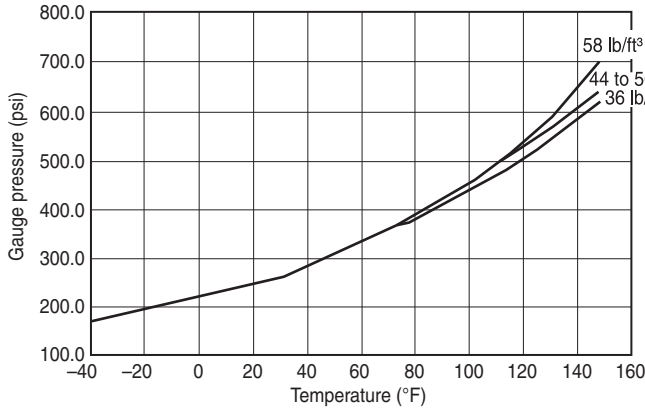

(1) Pressurized with nitrogen to 360 psi

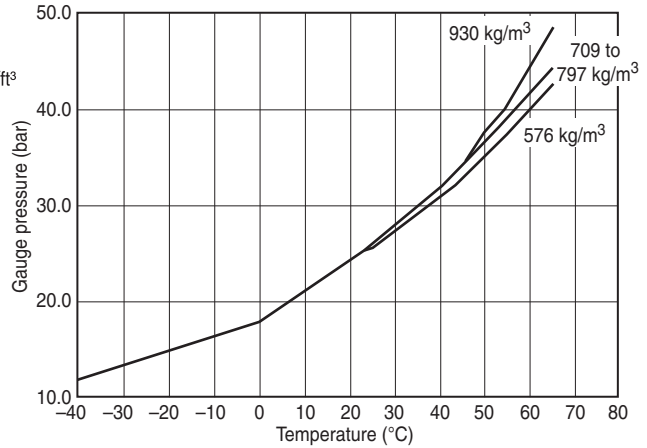

(2) Pressurized with nitrogen to 25 bar

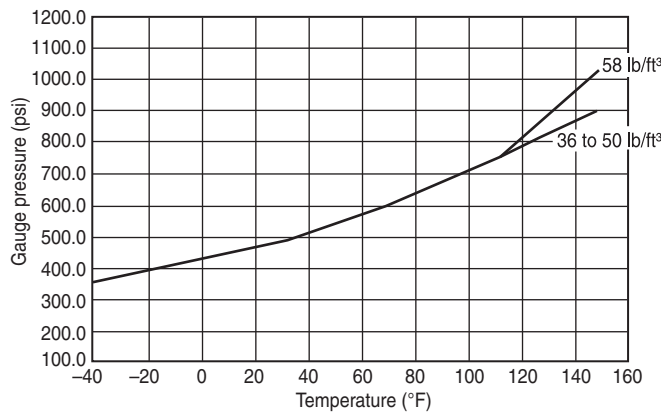

(3) Pressurized with nitrogen to 600 psi

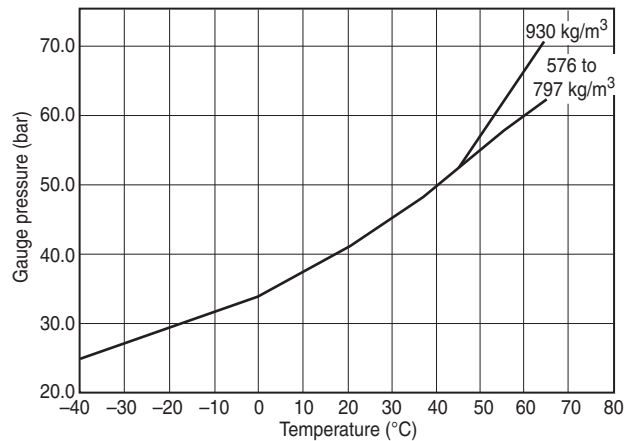

(4) Pressurized with nitrogen to 42 bar

FIGURE A.4.1.4.1(m) Isometric Diagram of HFC Blend B.

▲ **A.5.3** NFPA 75, 6.1.3.3, offers clear guidance on the construction of an enclosure being protected by clean agent fire extinguishing systems, specifically that “the fire-resistant-rated enclosures shall extend from the structural floor to the structural floor above or to the roof.” Proper room construction will ensure that the integrity of the room will be maintained and that the extinguishing agent concentration will be held for the required duration.

A.5.3.5.1 NFPA 75, 9.1.1.3, requires an automatic fire suppression system to be installed for the protection of the area below the raised floor in an information technology equipment room or information technology equipment area containing combustible material. NFPA 75, A.9.1.1.3, notes that halocarbon agents should not be used to protect the space below a raised floor unless the space above the raised floor is likewise protected by the system and the system is designed to discharge simultaneously into both the space below the raised floor and the room above the raised floor.

During and after a discharge, some of the agent from the space under the raised floor will migrate into the room above the raised floor. If any fire exists in the equipment above the

raised floor, the agent at a concentration below the extinguishing concentration may be exposed to the fire. If the agent is a halocarbon, considerable decomposition of the agent could occur. Note that NFPA 12A, in 5.3.1.2, also prohibits the use of Halon 1301 for flooding the space under a raised floor if the room above the raised floor is not simultaneously protected by the Halon 1301 total flooding system.

A.5.3.6 Examples of ventilation systems necessary to ensure safety include cooling of vital equipment required for process safety and ventilation systems required for containment of hazardous materials. Where recirculating ventilation is not shut off, additional agent could be needed to compensate for room leakage during the hold time.

A.5.3.7 Enclosure pressures developed during the discharge of a clean agent system are dependent on many variables, including factors unique to each agent, system, and enclosure. Over- or underpressurization of the enclosure can occur during the discharge.

▲ Table A.4.2.2.2(a) Piping Systems Fittings

Clean Agent	Pressure in Agent Container at 70°F (21°C) (up to and including)		Fitting Minimum Design Pressure ^a		Minimum Acceptable Fittings	Maximum Pipe Size (NPS)
	psi	kPa	psi	kPa		
All halocarbon agents (except HFC-23)	360	2,482	432	2,979	Class 300 threaded malleable iron Class 300 threaded ductile iron Groove type fittings ^b Class 300 flanged joints	3 in. All 6 in. All
	600	4,137	820	5,654	Class 300 threaded malleable iron Class 2,000 threaded/welded forged steel Class 400 flanged joint	4 in. All All
HFC-23	609	4,199	1,746	12,038 ^c	Class 300 threaded malleable iron Class 2,000 threaded/welded forged steel Class 600 flanged joint	1 in. All All
IG-541	2,175	14,997	2,175	14,997	Class 3,000 threaded/welded forged steel Class 1,500 flanged joint	All All
					Upstream of the pressure reducer Downstream of the pressure reducer ^d	— ^d
	2,900	19,996	2,900	19,996	Class 3,000 threaded/welded forged steel Class 1,500 flanged joint	All All
					Upstream of the pressure reducer Downstream of the pressure reducer ^d	— ^d
4,503	31,047	4,503	31,047	Class 6,000 threaded/welded forged steel joint Class 2,500 flanged joint	All All	
IG-01	2,370	16,341	2,370	16,341	Class 3,000 threaded/welded forged steel Class 1,500 flanged joint	All All
					Upstream of the pressure reducer Downstream of the pressure reducer ^d	— ^d
	2,964	20,346	2,964	20,346	Class 3,000 threaded/welded forged steel Class 1,500 flanged joint	All All
					Upstream of the pressure reducer Downstream of the pressure reducer	— ^d
4,510	31,097	4,510	31,097	Class 6,000 threaded/welded forged steel Class 2,500 flanged joint	All All	
IG-55	2,175	14,996	2,175	14,996	Class 3,000 threaded/welded forged steel Class 1,500 flanged joint	All All
					Upstream of the pressure reducer Downstream of the pressure reducer ^d	— ^d
	2,900	19,995	2,900	19,995	Class 3,000 threaded/welded forged steel	All
					Upstream of the pressure reducer Downstream of the pressure reducer	^d

(continues)

△ Table A.4.2.2.2(a) *Continued*

Clean Agent	Pressure in Agent Container at 70°F (21°C) (up to and including)		Fitting Minimum Design Pressure ^a		Minimum Acceptable Fittings	Maximum Pipe Size (NPS)	
	psi	kPa	psi	kPa			
	4,350	29,992	Upstream of the pressure reducer		Class 1,500 flanged joint	All	
			Downstream of the pressure reducer ^d	4,350	29,992	Class 6,000 threaded/welded forged steel	All
			Upstream of the pressure reducer			Class 2,500 flanged joint	All
			Downstream of the pressure reducer ^d				
IG-100	2,404	16,575	Upstream of the pressure reducer		Class 3,000 threaded/welded forged steel	All	
			Downstream of the pressure reducer ^d	2,404	16,575	Class 1,500 flanged joint	All
	3,236	22,312	Upstream of the pressure reducer				
			Downstream of the pressure reducer ^d	3,236	22,312	Class 6,000 threaded/welded forged steel	All
	4,061	28,000	Upstream of the pressure reducer				
			Downstream of the pressure reducer ^d	4,061	28,000	Class 1,500 flanged joint	All
			Upstream of the pressure reducer			Class 6,000 threaded/welded forged steel	All
			Downstream of the pressure reducer ^d	4,061	28,000	Class 2,500 flanged joint	All

Notes:

(1) All fitting ratings shown are based on open-ended piping systems.

(2) The materials in this table do not preclude the use of other materials and other types and styles of fittings that satisfy the requirements of 4.2.2.2 and 4.2.2.3.

^a Minimum design pressures taken from Table 4.2.1.1.1(a) and Table 4.2.1.1.1(b).

^b Check with grooved fitting manufacturers for pressure ratings.

^c This value good for all fill densities up to 48 lb/ft³.

^d The minimum design pressure for fittings downstream of the pressure reducer should be determined by system flow calculations. Acceptable pipe fittings for several values of pressures downstream of the pressure reducer can be found in Table A.4.2.2.2(b).

△ A.5.4.2.1 This standard requires that the flame extinguishing concentration of a gaseous agent for a Class B fuel be determined by the cup burner method. Cup burner testing in the past has involved a variety of techniques, apparatus, and investigators. It was reported by Senecal (2005) that significant inconsistencies are apparent in Class B flame extinguishing data for inert gases currently in use in national and international standards. In 2003, the Technical Committee for NFPA 2001 appointed a task group to develop an improved cup burner test method. Through this effort, the degree of standardization of the cup burner test method was significantly improved. A standard cup burner test procedure with defined apparatus has now been established and is outlined in Annex B. Values for minimum flame extinguishing concentration (MEC) for gaseous agents addressed in this standard, as determined by the revised test method, are given in Table A.5.4.2.1. Values for MEC that were determined by the 2004 test method are

retained in this edition for the purpose of providing an MEC reference where data obtained by the revised test method were not available. It is intended that in subsequent editions the 2004 MEC data can be deleted.

△ A.5.4.2.2 The following steps detail the fire extinguishment/area coverage fire test procedure for engineered and pre-engineered clean agent extinguishing system units:

(1) The general requirements are as follows:

- (a) An engineered or pre-engineered extinguishing system should mix and distribute its extinguishing agent and should totally flood an enclosure when tested in accordance with the recommendations of A.5.4.2.2(1)(c) through A.5.4.2.2(6)(f) under the maximum design limitations and most severe installation instructions. See also A.5.4.2.2(1)(b).

Table A.4.2.2(b) Piping Systems Fittings for Use in Inert Gas Systems Downstream of the Pressure Reducer

Maximum Pressure Downstream of the Pressure Reducer at 70°F (21°C) (up to and including)		Minimum Acceptable Fittings	Maximum Pipe Size (NPS)
psi	kPa		
1,000	6,895	Class 300 threaded malleable iron	3 in.
		Class 2,000 threaded/welded forged steel	All
		Class 600 flanged joint	All
1,350	9,308	Class 300 threaded malleable iron	2 in.
		Class 2,000 threaded/welded forged steel	All
		Class 600 flanged joint	All
1,500	10,343	Class 300 threaded malleable iron	2 in.
		Class 2,000 threaded/welded forged steel	All
		Class 900 flanged joint	All
2,000	13,790	Class 300 threaded malleable iron	1 in.
		Class 2,000 threaded/welded forged steel	All
		Class 900 flanged joint	All

Table A.5.4.2.1 Minimum Flame Extinguishing Concentration (Fuel: n-heptane)

Agent	MEC (vol %)	
	2004 Test Method	2008 Test Method**
FIC-1311	3.2*	
FK-5-1-12	4.5	
HCFC Blend A	9.9	
HCFC-124	6.6	
HFC-125	8.7	
HFC-227ea	6.6†	6.62
HFC-23	12.9	
HFC-236fa	6.3	
HFC Blend B	11.3	
IG-01	42	
IG-100	31*	32.2
IG-541	31	
IG-55	35	

*Not derived from standardized cup burner method.

†A value of cup burner extinguishing concentration of 6.7 percent for HCF-227ea for commercial heptane fuel.

**A working group appointed by the then NFPA 2001 technical committee revised Annex B to include a refinement of the method reported in the 2004 and earlier editions.

- (b) When tested as described in A.5.4.2.2(2)(a) through A.5.4.2.2(5)(b), an extinguishing system unit should extinguish all fires within 30 seconds after the end of system discharge. When tested as described in A.5.4.2.2(2)(a) through A.5.4.2.2(3)(c) and A.5.4.2.2(6)(a) through A.5.4.2.2(6)(f), an extinguishing system should prevent reignition of the wood crib after a 10 minute soak period.
- (c) The tests described in A.5.4.2.2(2)(a) through A.5.4.2.2(6)(f) should be carried out. Consider the intended use and limitations of the extinguishing system, with specific reference to the following:
- The area coverage for each type of nozzle
 - The operating temperature range of the system
 - Location of the nozzles in the protected area
 - Either maximum length and size of piping and number of fittings to each nozzle or minimum nozzle pressure
 - Maximum discharge time
 - Maximum fill density

(2) The test enclosure construction is as follows:

- (a) The enclosure for the test should be constructed of either indoor or outdoor grade minimum $\frac{3}{8}$ in. (9.5 mm) thick plywood or equivalent material.
- (b) An enclosure(s) is to be constructed having the maximum area coverage for the extinguishing system unit or nozzle being tested and the minimum and maximum protected area height limitations.

The test enclosure(s) for the maximum height, flammable liquid, and wood crib fire extinguishment tests need not have the maximum coverage area, but should be at least 13.1 ft (4.0 m) wide by 13.1 ft (4.0 m) long and 3351 ft³ (100 m³) in volume.

(3) The extinguishing system is as follows:

- (a) A pre-engineered type of extinguishing system unit is to be assembled using its maximum piping limitations with respect to number of fittings and length of pipe to the discharge nozzles and nozzle configuration(s), as specified in the manufacturer's design and installation instructions.
- (b) An engineered-type extinguishing system unit is to be assembled using a piping arrangement that results in the minimum nozzle design pressure at 70°F (21°C).

(c) Except for the flammable liquid fire test using the 2.5 ft² (0.23 m²) square pan and the wood crib extinguishment test, the cylinders are to be conditioned to the minimum operating temperature specified in the manufacturer's installation instructions.

(4) The extinguishing concentration is as follows:

- (a) The extinguishing agent concentration for each Class A test is to be 83.34 percent of the intended end use design concentration specified in the manufacturer's design and installation instructions at the ambient temperature of approximately 70°F (21°C) within the enclosure.
- (b) The extinguishing agent concentration for each Class B test is to be 76.9 percent of the intended end-use design concentration specified in the

manufacturer's design and installation instructions at the ambient temperature of approximately 70°F (21°C) within the enclosure.

- (c) The concentration for inert gas clean agents can be adjusted to take into consideration actual leakage measured from the test enclosure.
- (d) The concentration within the enclosure for halocarbon clean agents should be calculated using the following formula unless it is demonstrated that the test enclosure exhibits significant leakage. If significant test enclosure leakage does exist, the formula used to determine the test enclosure concentration of halocarbon clean agents can be modified to account for the leakage measured.

[A.5.4.2.2a]

$$W = \frac{V}{s} \left(\frac{C}{100 - C} \right)$$

where:

W = weight of clean agents [lb (kg)]

V = volume of test enclosure [ft³ (m³)]

s = specific volume of clean agent at test temperature [ft³/lb (m³/kg)]

C = concentration (vol %)

- (5) The flammable liquid extinguishment tests are as follows:

- (a) Steel test cans having a nominal thickness of 0.216 in. (5.5 mm) (such as Schedule 40 pipe) and 3.0 in. to 3.5 in. (76.2 mm to 88.9 mm) in diameter and at least 4 in. (102 mm) high, containing either heptane or heptane and water, are to be placed within 2 in. (50.8 mm) of the corners of the test enclosure(s) and directly behind the baffle, and located vertically within 12 in. (305 mm) of the top or bottom of the enclosure or both the top and bottom if the enclosure permits such placement. If the cans contain heptane and water, the heptane is to be at least 2 in. (50.8 mm) deep. The level of heptane in the cans should be at least 2 in. (50.8 mm) below the top of the can. For the minimum room height area coverage test, closable openings are provided directly above the cans to allow for venting prior to system installation. In addition, for the minimum height limitation area coverage test, a baffle is to be installed between the floor and ceiling in the center of the enclosure. The baffle is to be perpendicular to the direction of nozzle discharge and to be 20 percent of the length or width of the enclosure, whichever is applicable with respect to nozzle location. For the maximum room height extinguishment test, an additional test is to be conducted using a 2.5 ft² (0.23 m²) square pan located in the center of the room and the storage cylinder conditioned to 70°F (21°C). The test pan is to contain at least 2 in. (50.8 mm) of heptane, with the heptane level at least 2 in. (50.8 mm) below the top of the pan. For all tests, the heptane is to be ignited and allowed to burn for 30 seconds, at which time all openings are to be closed and the extinguishing system is to be manually actuated. At the time of actuation, the percent of oxygen within the enclosure should be at least 20 percent.

- (b) The heptane is to be commercial grade having the following characteristics:

- i. Initial boiling point: 194°F (90°C) minimum
- ii. Dry point: 212°F (100°C) maximum
- iii. Specific gravity: 0.69–0.73

- (6) The wood crib extinguishment tests are as follows:

- (a) The storage cylinder is to be conditioned to 70°F (21°C). The test enclosure is to have the maximum ceiling height as specified in the manufacturer's installation instructions.

- (b) The wood crib is to consist of four layers of six, trade size 2 by 2 (1½ by 1½ in.) by 18 in. long, kiln spruce or fir lumber having a moisture content between 9 percent and 13 percent. The alternate layers of the wood members are to be placed at right angles to one another. The individual wood members in each layer are to be evenly spaced, forming a square determined by the specified length of the wood members. The wood members forming the outside edges of the crib are to be stapled or nailed together.

- (c) Ignition of the crib is to be achieved by the burning of commercial grade heptane in a square steel pan 2.5 ft² (0.23 m²) in area and not less than 4 in. (101.6 mm) in height. The crib is to be centered with the bottom of the crib 12 in. to 24 in. (304 to 609.6 mm) above the top of the pan, and the test stand constructed so as to allow for the bottom of the crib to be exposed to the atmosphere.

- (d) The heptane is to be ignited, and the crib is to be allowed to burn freely for approximately 6 minutes outside the test enclosure. The heptane fire is to burn for 3 to 3½ minutes. Approximately ¼ gal (0.95 L) of heptane will provide a 3 to 3½ minute burn time. Just prior to the end of the pre-burn period, the crib is to be moved into the test enclosure and placed on a stand such that the bottom of the crib is between 20 in. and 28 in. (508 mm and 711 mm) above the floor. The closure is then to be sealed.

- (e) After the crib is allowed to burn for 6 minutes, the system is to be actuated. At the time of actuation, the percent of oxygen within the enclosure at the level of the crib should be at least 20 percent.

- (f) After the end of system discharge, the enclosure is to remain sealed for 10 minutes. After the 10 minute soak period, the crib is to be removed from the enclosure and observed to determine whether sufficient fuel remains to sustain combustion and to detect signs of re-ignition.

- (7) The following is a schematic of the process to determine the design quantity:

- (a) Determine hazard features, as follows:

- i. Fuel type: Extinguishing concentration (EC) per 5.4.2 or inerting concentration (IC) per 5.4.3
- ii. Enclosure volume
- iii. Enclosure temperature
- iv. Enclosure barometric pressure

- (b) Determine the agent minimum design concentration (MDC) by multiplying EC or IC by the safety factor (SF):

[A.5.4.2.2b]

$$\text{MDC} = (\text{EC or IC}) \text{ SF}$$

- (c) Determine the agent minimum design quantity (MDQ) by referring to 5.5.1 for halocarbons or 5.5.2 for inert gases
- (d) Determine whether design factors (DF) apply. See 5.5.3 to determine individual DF [DF(i)] and then determine sum:

[A.5.4.2.2c]

$$\text{DF} = \Sigma \text{DF}(i)$$

- (e) Determine the agent adjusted minimum design quantity (AMDQ):

[A.5.4.2.2d]

$$\text{AMDQ} = \text{MDQ} (1 + \text{DF})$$

- (f) Determine the pressure correction factor (PCF) per 5.5.3.3
- (g) Determine the final design quantity (FDQ) as follows:

[A.5.4.2.2e]

$$\text{FDQ} = \text{AMDQ} \times \text{PCF}$$

Where any of the following conditions exist, higher extinguishing concentrations might be required:

- (1) Cable bundles greater than 4 in. (100 mm) in diameter
- (2) Cable trays with a fill density greater than 20 percent of the tray cross section
- (3) Horizontal or vertical stacks of cable trays less than 10 in. (250 mm) apart
- (4) Equipment energized during the extinguishment period where the collective power consumption exceeds 5 kW

Fire extinguishment tests for (noncellulosic) Class A Surface Fires. The purpose of the tests outlined in this procedure is to develop the minimum extinguishing concentration (MEC) for a gaseous fire suppression agent for a range of noncellulosic, solid polymeric combustibles. It is intended that the MEC will be increased by appropriate safety factors and flooding factors as provided for in the standard.

These Class A tests should be conducted in a draft-free room with a volume of at least 3530 ft³ (100 m³) and a minimum height of 11.5 ft (3.5 m) and each wall at least 13.1 ft (4 m) long. Provisions should be made for relief venting if required.

The test objects are as follows:

- (1) The polymer fuel array consists of four sheets of polymer, 3/8 in. (9.53 mm) thick, 16 in. (406 mm) tall, and 8 in. (203 mm) wide. Sheets are spaced and located per Figure A.5.4.2.2(a). The bottom of the fuel array is located 8 in. (203 mm) from the floor. The fuel sheets should be mechanically fixed at the required spacing.
- (2) A fuel shield is provided around the fuel array as indicated in Figure A.5.4.2.2(a). The fuel shield is 15 in.

(381 mm) wide, 33.5 in. (851 mm) high, and 24 in. (610 mm) deep. The 24 in. (610 mm) wide × 33.5 in. (851 mm) high sides and the 24 in. (610 mm) × 15 in. (381 mm) top are sheet metal. The remaining two sides and the bottom are open. The fuel array is oriented in the fuel shield such that the 8 in. (203 mm) dimension of the fuel array is parallel to the 24 in. (610 mm) side of the fuel shield.

- (3) Two external baffles measuring 40 in. × 40 in. (1 m × 1 m) and 12 in. (0.3 m) tall are located around the exterior of the fuel shield as shown in Figure A.5.4.2.2(a) and Figure A.5.4.2.2(b). The baffles are placed 3.5 in. (0.09 m) above the floor. The top baffle is rotated 45 degrees with respect to the bottom baffle.
- (4) Tests are conducted for three plastic fuels — polymethyl methacrylate (PMMA), polypropylene (PP), and acrylonitrile-butadiene-styrene (ABS) polymer. Plastic properties are given in Table A.5.4.2.2(a).
- (5) The ignition source is a heptane pan 2 in. × 2 in. × 7/8 in. deep (51 mm × 51 mm × 22 mm deep) centered 1/2 in. (12 mm) below the bottom of the plastic sheets. The pan is filled with 3.0 ml of heptane to provide 90 seconds of burning.
- (6) The agent delivery system should be distributed through an approved nozzle. The system should be operated at the minimum nozzle pressure (±10 percent) and the maximum discharge time (±1 second).

The test procedure is as follows:

- (1) The procedures for ignition are as follows:
 - (a) The heptane pan is ignited and allowed to burn for 90 seconds.
 - (b) The agent is discharged 210 seconds after ignition of heptane.
 - (c) The compartment remains sealed for 600 seconds after the end of discharge. Extinguishment time is noted. If the fire is not extinguished within 600 seconds of the end of agent discharge, a higher minimum extinguishing concentration must be utilized.
 - (d) The test is repeated two times for each fuel for each concentration evaluated and the extinguishment time averaged for each fuel. Any one test with an extinguishment time above 600 seconds is considered a failure.
 - (e) If the fire is extinguished during the discharge period, the test is repeated at a lower concentration or additional baffling provided to ensure that local transient discharge effects are not affecting the extinguishment process.
 - (f) At the beginning of the tests, the oxygen concentration must be within 2 percent (approximately 0.5 percent by volume O₂) of ambient value.
 - (g) During the post-discharge period, the oxygen concentration should not fall below 0.5 percent by volume of the oxygen level measured at the end of agent discharge.
- (2) The observation and recording procedures are as follows:
 - (a) The following data must be recorded continuously during the test:
 - i. Oxygen concentration (±0.5 percent)
 - ii. Fuel mass loss (±5 percent)

- iii. Agent concentration (± 5 percent) (Inert gas concentration can be calculated based on oxygen concentration.)
- (b) The following events are timed and recorded:
 - i. Time at which heptane is ignited
 - ii. Time of heptane pan burnout
 - iii. Time of plastic sheet ignition
 - iv. Time of beginning of agent discharge
 - v. Time of end of agent discharge
 - vi. Time all visible flame is extinguished

The minimum extinguishing concentration is determined by all of the following conditions:

- (1) All visible flame is extinguished within 600 seconds of agent discharge.
- (2) The fuel weight loss between 10 seconds and 600 seconds after the end of discharge does not exceed 0.5 oz (15 g).
- (3) There is no ignition of the fuel at the end of the 600 second soak time and subsequent test compartment ventilation.

Deep-seated fires involving Class A fuels can require substantially higher design concentrations and extended holding times than the design concentrations and holding times required for surface-type fires involving Class A fuels. Wood crib and polymeric sheet Class A fire tests may not adequately indicate extinguishing concentrations suitable for the protection of certain plastic fuel hazards (e.g., electrical- and electronic-type hazards involving grouped power or data cables such as computer and control room underfloor voids and telecommunication facilities).

The values in Table A.5.4.2.2(b) are representative of the minimum extinguishing concentrations and design concentrations for various agents. The concentrations required can vary by equipment manufacturer. Equipment manufacturers should be contacted for the concentration required for their specific system.

A.5.4.2.4 Hazards containing both Class A and Class B fuels should be evaluated on the basis of the fuel requiring the highest design concentration.

A.5.4.2.6 Two types of fires can occur in solid fuels: (1) one in which volatile gases resulting from heating or decomposition of the fuel surface are the source of combustion and (2) one in which oxidation occurs at the surface of or in the mass of fuel. The first type of fire is commonly referred to as “flaming” combustion, while the second type is often called “smoldering” or “glowing” combustion. The two types of fires frequently occur concurrently, although one type of burning can precede the other. For example, a wood fire can start as flaming combustion and become smoldering as burning progresses. Conversely, spontaneous ignition in a pile of oily rags can begin

Table A.5.4.2.2(b) Class A Flame Extinguishing and Minimum Design Concentrations Tested to UL 2166 and UL 2127

Agent	Class A MEC	Class A	Class C
		Minimum Design Concentration	Minimum Design Concentration
FK-5-1-12	3.3	4.5	4.5
HFC-125	6.7	8.7	9.0
HFC-227ea	5.2	6.7	7.0
HFC-23	15.0	18.0	20.3
IG-541	28.5	34.2	38.5
IG-55	31.6	37.9	42.7
IG-100	31.0	37.2	41.9

Note: Concentrations reported are at 70°F (21°C). Class A design values are the greater of (1) the Class A extinguishing concentration, determined in accordance with 5.4.2.2, times a safety factor of 1.2; or (2) the minimum extinguishing concentration for heptane as determined from 5.4.2.1.

as a smoldering fire and break into flames at some later point. Flaming combustion, because it occurs in the vapor phase, can be extinguished with relatively low levels of clean agents. In the absence of smoldering combustion, it will stay out.

Unlike flaming combustion, smoldering combustion is not subject to immediate extinguishment. Characteristic of this type of combustion is the slow rate of heat losses from the reaction zone. Thus, the fuel remains hot enough to react with oxygen, even though the rate of reaction, which is controlled by diffusion processes, is extremely slow. Smoldering fires can continue to burn for many weeks, for example, in bales of cotton and jute and heaps of sawdust. A smoldering fire ceases to burn only when either all the available oxygen or fuel has been consumed or the fuel surface is at too low a temperature to react. Smoldering fires usually are extinguished by reducing the fuel temperature, either directly by application of a heat-absorbing medium, such as water, or by blanketing with an inert gas. The inert gas slows the reaction rate to the point where heat generated by oxidation is less than heat losses to surroundings. This causes the temperature to fall below the level necessary for spontaneous ignition after removal of the inert atmosphere.

For the purposes of this standard, smoldering fires are divided into two classes: (1) where the smoldering is not “deep seated” and (2) deep-seated fires. Whether a fire will become deep seated depends, in part, on the length of time it has been burning before application of the extinguishing agent. This time is usually called the “preburn” time.

Table A.5.4.2.2(a) Plastic Fuel Properties

25 kW/m ² Exposure in Cone Calorimeter — ASTM E1354								
Fuel	Color	Density (g/cm ³)	Ignition Time		180-Second Average Heat Release Rate		Effective Heat of Combustion	
			sec	Tolerance	kW/m ²	Tolerance	MJ/kg	Tolerance
PMMA	Black	1.19	77	$\pm 30\%$	286	25%	23.3	$\pm 15\%$
PP	Natural (white)	0.905	91	$\pm 30\%$	225	25%	39.8	$\pm 15\%$
ABS	Natural (cream)	1.04	115	$\pm 30\%$	484	25%	29.1	$\pm 15\%$

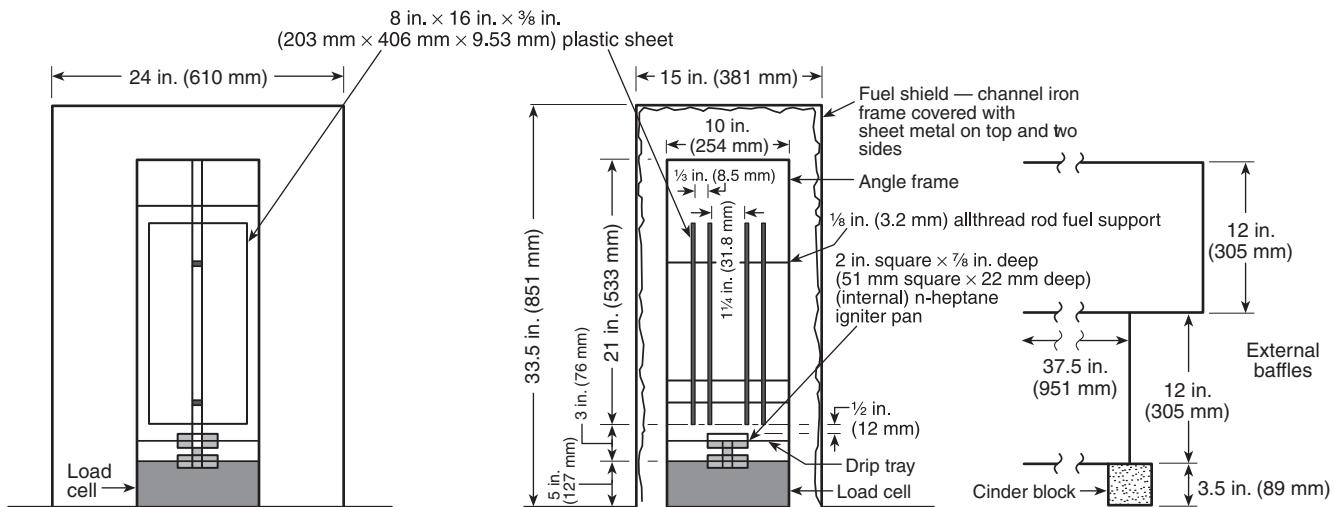

FIGURE A.5.4.2(a) Four-Piece Modified Plastic Setup.

Another important variable is the fuel configuration. While wood cribs and pallets are easily extinguished with Class A design concentrations, vertical wood panels closely spaced and parallel can require higher concentrations and long hold times for extinguishment. Fires in boxes of excelsior and in piles of shredded paper also can require higher concentrations and long hold times for extinguishment. In these situations, heat tends to be retained in the fuel array rather than being dissipated to the surroundings. Radiation is an important mechanism for heat removal from smoldering fires.

▲ A.5.4.3 The following paragraphs summarize a method of evaluating inerting concentration of a fire extinguishing vapor.

One characteristic of halons and replacement agents is frequently referred to as the inerting, or inhibiting, concentration. Flammability diagram data (Dalzell, 1975, and Coll, 1976) on ternary systems can be found in NFPA 12A. The procedures used to generate those data have been used more recently to evaluate inerting concentrations of halons and replacement chemicals against various fuel-air systems. Differences between the earlier studies and the recent work are that the test vessel volume used in the more recent work was 2.1 gal (7.9 L) versus the 1.5 gal (5.6 L) used previously. The igniter type — carbon rod corona discharge spark — was the same, but the capacitor-stored energy levels in the later studies were higher, approximately 68 J (16.2 cal) versus 6 or 11 J (1.4 or 2.6 cal) in the earlier work. The basic procedure, employing a gap spark, has been adopted to develop additional data.

Ternary fuel-air agent mixtures were prepared at a test pressure of 1 atm and at room temperature in a 2.1 gal (7.9 L) spherical test vessel (see Figure A.5.4.3) by the partial pressure method. The vessel was fitted with inlet and vent ports, a thermocouple, and a pressure transducer. First, the test vessel was evacuated, then agent was admitted; if the agent was a liquid, sufficient time was allowed for evaporation to occur. Fuel vapor and finally air were admitted, raising the vessel pressure to 1 atm. An internal flapper allowed the mixtures to be agitated by rocking the vessel back and forth. The pressure transducer was connected to a suitable recording device to measure any pressure rise that occurred on actuation of the igniter.

The igniter employed consisted of a bundle of four graphite rods (“H” pencil leads) held together by two wire or metal brand wraps on either end of the bundle, leaving a gap between the wraps of about 0.12 in. (3 mm). The igniter was wired in series with two 525 mF 450 V capacitors. The capacitors were charged to a potential of 720 to 730 V dc. The stored energy was, therefore, 68 to 70 J (16.2 to 16.7 cal). The nominal resistance of the rod assembly was about 1 ohm. On switch closure, the capacitor discharge current resulted in ionization at the graphite rod surface. A corona spark jumped across the connector gap. The spark energy content was taken as the stored capacitor energy; in principle, however, stored capacitor energy must be somewhat less than this amount due to line resistance losses.

The pressure rise, if any, resulting from ignition of the test mixture was recorded. The interior of the test vessel was wiped clean between tests with a cloth damp with either water or a solvent to avoid buildup of decomposition residues, which could influence the results.

The definition of the flammable boundary was taken as that composition that just produces a pressure rise of 0.07 times the initial pressure or 1 psi (6.9 kPa) when the initial pressure is 1 atm. Tests were conducted at fixed fuel-air ratios and varying amounts of agent vapor until conditions were found to give rise to pressure increases that bracket 0.07 times the initial pressure. Tests were conducted at several fuel-air ratios to establish that condition requiring the highest agent vapor concentration to inert.

Data obtained on several chemicals that can serve as fire protection agents are given in Table A.5.4.3.

A.5.4.3.2 These conditions exist where both the following occur:

- (1) The types and quantity of fuel permitted in the enclosure have the potential to lead to development of a fuel vapor concentration equal to or greater than one-half of the lower flammable limit throughout the enclosure.
- (2) The system response is not rapid enough to detect and extinguish the fire before the volatility of the fuel is increased to a dangerous level as a result of the fire.

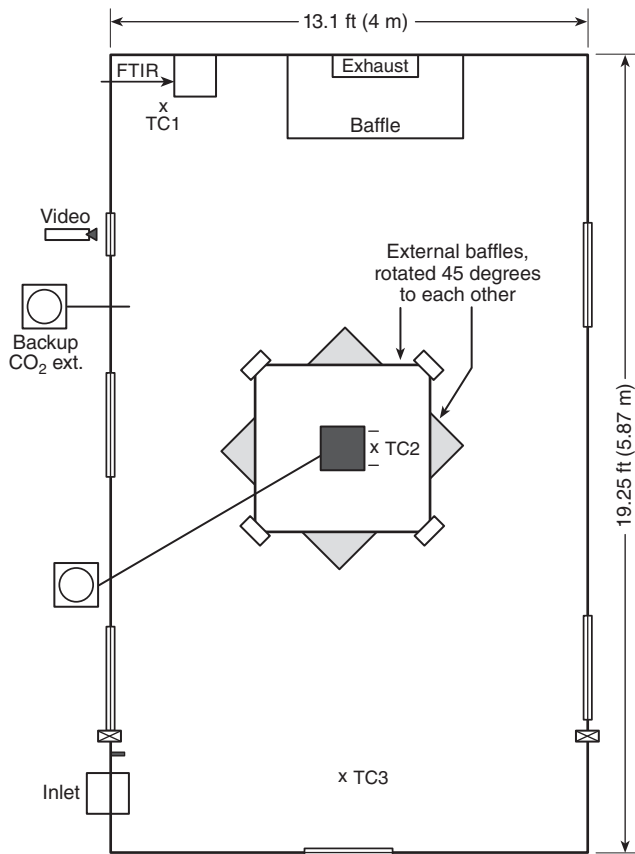

- x TC1— 0 in. (0 mm), 12 in. (305 mm), 24 in. (610 mm), 48 in. (1220 mm), 72 in. (1.8 m), 96 in. (2.4 m), 120 in. (3 m) from ceiling
- x TC2— 0 in. (0 mm), 12 in. (305 mm), 24 in. (610 mm), 48 in. (1220 mm), 72 in. (1.8 m), 96 in. (2.4 m), 120 in. (3 m) from ceiling
- x TC3— 0 in. (0 mm), 12 in. (305 mm), 24 in. (610 mm), 48 in. (1220 mm), 72 in. (1.8 m), 96 in. (2.4 m), 120 in. (3 m) from ceiling
- ☒ ODM — 12 in. (305 mm) down from ceiling
- FTIR — 27 in. (686 mm) up from floor
- Noisemeter — 12 in. (305 mm) down from ceiling
- FTIR — Fourier transform infrared (spectrometer)
- ODM — Oxygen deficiency monitor
- TC — Thermocouple

▲ FIGURE A.5.4.2(b) Chamber Plan View.

A.5.5.1 The quantity of clean agent required to develop a given concentration will be greater than the final quantity of agent in the same enclosure. In most cases, the clean agent must be applied in a manner that promotes progressive mixing of the atmosphere. As the clean agent is injected, the displaced atmosphere is exhausted freely from the enclosure through small openings or through special vents. Some clean agent is therefore lost with the vented atmosphere, and the higher the concentration, the greater the loss of clean agent.

For the purposes of this standard, it is assumed that the clean agent-air mixture lost in this manner contains the final design concentration of the clean agent. This represents the worst case from a theoretical standpoint and provides a built-in safety factor to compensate for nonideal discharge arrangements.

▲ Table A.5.4.3 Inerting Concentrations for Various Agents

Fuel	Agent	Inerting Concentration (vol %)	Reference
i-butane	HFC-227ea	11.3	Robin
	HCFC Blend A	18.4	Moore
	IG-100	40	Zabetakis
1-chloro-1,1-difluoroethane (HCFC-142b)	HFC-227ea	2.6	Robin
	HFC-227ea	8.6	Robin
1,1-difluoroethane (HFC-152a)	HFC-227ea	8.6	Robin
Difluoromethane (HFC-32)	HCFC Blend A	13.6	Moore
	HFC-227ea	3.5	Robin
Ethane	HCFC Blend A	8.6	Moore
Ethylene oxide	HFC-227ea	13.6	Robin
	IG-100	44	Zabetakis
Hexane	HFC-227ea	42	Zabetakis
	IG-100	42	Zabetakis
Methane	FK-5-1-12	8.8	Schmeer
	HFC-125	14.7	Senecal
	HFC-227ea	8	Robin
	HFC-23	20.2	Senecal
	HCFC Blend A	18.3	Moore
	IG-100	37	Zabetakis
	IG-541	43	Tamanini
	IG-100	42	Zabetakis
	IG-100	42	Zabetakis
Pentane	HFC-227ea	11.6	Robin
	IG-100	42	Zabetakis
	IG-100	42	Zabetakis
Propane	FK-5-1-12	8.1	Schmeer
	FC-5-1-14	7.3	Senecal
	FIC-1311	6.5	Moore
	HFC-125	15.7	Senecal
	HFC-227ea	11.6	Robin
	HFC-23	20.2	Senecal
	HFC-23	20.4	Skaggs
	HCFC Blend A	18.6	Moore
	IG-541	49.0	Tamanini
IG-100	42	Zabetakis	

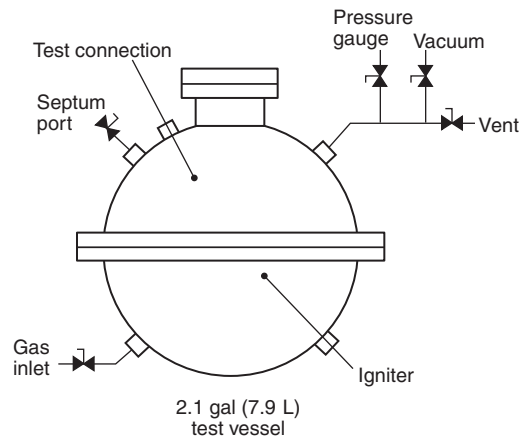

FIGURE A.5.4.3 Spherical Test Vessel.

Table A.5.5.1(a) through Table A.5.5.1(r) provide the quantity of clean agent needed to achieve design concentration.

[A.5.5.2a]

A.5.5.2 The volume of inert gas clean agent required to develop a given concentration will be greater than the final volume remaining in the same enclosure. In most cases, the inert gas clean agent must be applied in a manner that promotes progressive mixing of the atmosphere. As the clean agent is injected, the displaced atmosphere is exhausted freely from the enclosure through small openings or through special vents. Some inert gas clean agent is therefore lost with the vented atmosphere. This loss becomes greater at high concentrations. This method of application is called “free efflux” flooding.

$$e^x = \frac{100}{100 - \% \text{ IG}}$$

or

[A.5.5.2b]

$$X = 2.303 \log_{10} \frac{100}{100 - \% \text{ IG}}$$

where:

% IG = volume percent of inert gas

X = volume of inert gas added per volume of space

Under these conditions, the volume of inert gas clean agent required to develop a given concentration in the atmosphere is expressed by one of the following equations:

Table A.5.5.2(a) through Table A.5.5.2(h) provide the quantity of clean agent needed to achieve design concentration.

▲ **Table A.5.5.1(a) FK-5-1-12 Total Flooding Quantity (U.S. Units)^a**

Temp (<i>t</i>) (°F) ^c	Specific Vapor Volume (<i>s</i>) (ft ³ /lb) ^d	Weight Requirements of Hazard Volume, <i>W/V</i> (lb/ft ³) ^b							
		Design Concentration (% by Volume) ^e							
		3	4	5	6	7	8	9	10
-20	0.93678	0.0330	0.0445	0.0562	0.0681	0.0803	0.0928	0.1056	0.1186
-10	0.96119	0.0322	0.0433	0.0548	0.0664	0.0783	0.0905	0.1029	0.1156
0	0.9856	0.0314	0.0423	0.0534	0.0648	0.0764	0.0882	0.1003	0.1127
10	1.01001	0.0306	0.0413	0.0521	0.0632	0.0745	0.0861	0.0979	0.1100
20	1.03442	0.0299	0.0403	0.0509	0.0617	0.0728	0.0841	0.0956	0.1074
30	1.05883	0.0292	0.0394	0.0497	0.0603	0.0711	0.0821	0.0934	0.1049
40	1.08324	0.0286	0.0385	0.0486	0.0589	0.0695	0.0803	0.0913	0.1026
50	1.10765	0.0279	0.0376	0.0475	0.0576	0.0680	0.0785	0.0893	0.1003
60	1.13206	0.0273	0.0368	0.0465	0.0564	0.0665	0.0768	0.0874	0.0981
70	1.15647	0.0267	0.0360	0.0455	0.0552	0.0651	0.0752	0.0855	0.0961
80	1.18088	0.0262	0.0353	0.0446	0.0541	0.0637	0.0736	0.0838	0.0941
90	1.20529	0.0257	0.0346	0.0437	0.0530	0.0624	0.0721	0.0821	0.0922
100	1.22970	0.0252	0.0339	0.0428	0.0519	0.0612	0.0707	0.0804	0.0904
110	1.25411	0.0247	0.0332	0.0420	0.0509	0.0600	0.0693	0.0789	0.0886
120	1.27852	0.0242	0.0326	0.0412	0.0499	0.0589	0.0680	0.0774	0.0869
130	1.30293	0.0237	0.0320	0.0404	0.0490	0.0578	0.0667	0.0759	0.0853
140	1.32734	0.0233	0.0314	0.0397	0.0481	0.0567	0.0655	0.0745	0.0837
150	1.35175	0.0229	0.0308	0.0389	0.0472	0.0557	0.0643	0.0732	0.0822
160	1.37616	0.0225	0.0303	0.0382	0.0464	0.0547	0.0632	0.0719	0.0807
170	1.40057	0.0221	0.0297	0.0376	0.0456	0.0537	0.0621	0.0706	0.0793
180	1.42498	0.0217	0.0292	0.0369	0.0448	0.0528	0.0610	0.0694	0.0780
190	1.44939	0.0213	0.0287	0.0363	0.0440	0.0519	0.0600	0.0682	0.0767
200	1.47380	0.0210	0.0283	0.0357	0.0433	0.0511	0.0590	0.0671	0.0754
210	1.49821	0.0206	0.0278	0.0351	0.0426	0.0502	0.0580	0.0660	0.0742
220	1.52262	0.0203	0.0274	0.0346	0.0419	0.0494	0.0571	0.0650	0.0730

^aThe manufacturer's listing specifies the temperature range for the operation.

^b*W/V* [agent weight requirements (lb/ft³)] = pounds of agent required per cubic foot of protected volume to produce indicated concentration at temperature specified.

$$W = \frac{V}{s} \left(\frac{C}{100 - C} \right)$$

^c*t* [temperature (°F)] = design temperature in the hazard area.

^d*s* [specific volume (ft³/lb)] = specific volume of FK-5-1-12 vapor can be approximated by $s = 0.9856 + 0.002441t$, where *t* is the temperature (°F).

^e*C* [concentration (%)] = volumetric concentration of FK-5-1-12 in air at the temperature indicated.

Table A.5.5.1(b) FK-5-1-12 Total Flooding Quantity (SI Units)^a

Temp (<i>t</i>) (°C) ^c	Specific Vapor Volume (<i>s</i>) (m ³ /kg) ^d	Weight Requirements of Hazard Volume, <i>W/V</i> (kg/m ³) ^b							
		Design Concentration (% by Volume) ^e							
		3	4	5	6	7	8	9	10
-20	0.0609140	0.5077	0.6840	0.8640	1.0479	1.2357	1.4275	1.6236	1.8241
-15	0.6022855	0.4965	0.6690	0.8450	1.0248	1.2084	1.3961	1.5879	1.7839
-10	0.0636570	0.4859	0.6545	0.8268	1.0027	1.1824	1.3660	1.5337	1.7455
-5	0.0650285	0.4756	0.6407	0.8094	0.9816	1.1575	1.3372	1.5209	1.7087
0	0.0664000	0.4658	0.6275	0.7926	0.9613	1.1336	1.3096	1.4895	1.6734
5	0.0677715	0.4564	0.6148	0.7766	0.9418	1.1106	1.2831	1.4593	1.6395
10	0.0691430	0.4473	0.6026	0.7612	0.9232	1.0886	1.2576	1.4304	1.6070
15	0.0705145	0.4386	0.5909	0.7464	0.9052	1.0674	1.2332	1.4026	1.5757
20	0.0718860	0.4302	0.5796	0.7322	0.8879	1.0471	1.2096	1.3758	1.5457
25	0.0732575	0.4222	0.5688	0.7184	0.8713	1.0275	1.1870	1.3500	1.5167
30	0.0746290	0.4144	0.5583	0.7052	0.8553	1.0086	1.1652	1.3252	1.4888
35	0.0760005	0.4069	0.5482	0.6925	0.8399	0.9904	1.1442	1.3013	1.4620
40	0.0773720	0.3997	0.5385	0.6802	0.8250	0.9728	1.1239	1.2783	1.4361
45	0.0787435	0.3928	0.5291	0.6684	0.8106	0.9559	1.1043	1.2560	1.4111
50	0.0801150	0.3860	0.5201	0.6570	0.7967	0.9395	1.0854	1.2345	1.3869
55	0.0814865	0.3795	0.5113	0.6459	0.7833	0.9237	1.0671	1.2137	1.3636
60	0.0828580	0.3733	0.5029	0.6352	0.7704	0.9084	1.0495	1.1936	1.3410
65	0.0842295	0.3672	0.4947	0.6249	0.7578	0.8936	1.0324	1.1742	1.3191
70	0.0856010	0.3613	0.4868	0.6148	0.7457	0.8793	1.0158	1.1554	1.2980
75	0.0869725	0.3556	0.4791	0.6052	0.7339	0.8654	0.9998	1.1372	1.2775
80	0.0883440	0.3501	0.4716	0.5958	0.7225	0.8520	0.9843	1.1195	1.2577
85	0.0897155	0.3447	0.4644	0.5866	0.7115	0.8390	0.9692	1.1024	1.2385
90	0.0910870	0.3395	0.4574	0.5778	0.7008	0.8263	0.9547	1.0858	1.2198
95	0.0924585	0.3345	0.4507	0.5692	0.6904	0.8141	0.9405	1.0697	1.2017
100	0.0938300	0.3296	0.4441	0.5609	0.6803	0.8022	0.9267	1.0540	1.1842

^aThe manufacturer's listing specifies the temperature range for operation.

^b*W/V* [agent weight requirements (kg/m³)] = kilograms of agent required per cubic meter of protected volume to produce indicated concentration at temperature specified.

$$W = \frac{V}{s} \left(\frac{C}{100 - C} \right)$$

^c*t* [temperature (°C)] = design temperature in the hazard area.

^d*s* [specific volume (m³/kg)] = specific volume of FK-5-1-12 vapor can be approximated by $s = 0.0664 + 0.0002741t$, where *t* is the temperature (°C).

^e*C* [concentration (%)] = volumetric concentration of FK-5-1-12 in air at the temperature indicated.

A.5.5.2.1 Total flooding quantities based on Equations 5.5.2.1a and 5.5.2.1b are given in Table A.5.5.2(a) through Table A.5.5.2(h).

A.5.5.3 The minimum design concentration based either on the cup burner extinguishing concentration plus 30 percent or on Class A fire test extinguishing concentration plus 20 percent should encompass design tolerances for most applications. However, these safety factors do not account for specific conditions or requirements for some particular applications that can require additional agent to ensure complete fire extinguishment. The following list gives certain conditions or considerations that can require the use of design factors that would increase the quantity of agent used:

- (1) *Unclosable openings* (see also 5.7.2). Special considerations should be taken into account in the design of a fire suppression system for an enclosure that cannot or will not be sealed or closed before the fire suppression system is discharged. The loss of agent through the openings needs to be compensated for by some method. Compensation for unclosable openings can be handled through extending the discharge time, which in turn extends the

period of agent application. A method of determining the additional agent required/rate of application can be accomplished by conducting an enclosure integrity test per Annex C. When agent is applied to compensate for the loss through an unclosable opening, consideration needs to be taken to extend the discharge of agent to enable the concentration within the enclosure to be held for a longer period of time. The discharge time defined in 5.7.1.1.1 is for the time required for the initial agent required to protect the enclosure without leakage through the unclosable openings. Without extending the discharge time for the additional agent being applied, leak rates through the unclosable openings will increase.

- (2) *Acid gas formation considerations*. High concentrations of hydrogen fluoride (HF) can be expected at cup burner design concentrations. HF can be reduced by increasing the design concentration. Dramatic reduction can be achieved by increasing design concentration up to cup burner plus 30 percent. Above cup burner plus 30 percent, reduction in HF is not as dramatic. (For further information see Sheinson et al., 1994, and Sheinson et al., 1995.)

Table A.5.5.1(c) HCFC Blend A Total Flooding Quantity (U.S. Units)^a

Temp (<i>t</i>) (°F) ^c	Specific Vapor Volume (<i>s</i>) (ft ³ /lb) ^d	Weight Requirements of Hazard Volume, <i>W/V</i> (lb/ft ³) ^b							
		Design Concentration (% by Volume) ^e							
		8.6	9	10	11	12	13	14	15
-50	3.2192	0.0292	0.0307	0.0345	0.0384	0.0424	0.0464	0.0506	0.0548
-40	3.2978	0.0285	0.0300	0.0337	0.0375	0.0414	0.0453	0.0494	0.0535
-30	3.3763	0.0279	0.0293	0.0329	0.0366	0.0404	0.0443	0.0482	0.0523
-20	3.4549	0.0272	0.0286	0.0322	0.0358	0.0395	0.0433	0.0471	0.0511
-10	3.5335	0.0261	0.0280	0.0314	0.035	0.0386	0.0423	0.0461	0.0499
0	3.6121	0.0260	0.0274	0.0308	0.0342	0.0378	0.0414	0.0451	0.0489
10	3.6906	0.0255	0.0268	0.0301	0.0335	0.0369	0.0405	0.0441	0.0478
20	3.7692	0.0250	0.0262	0.0295	0.0328	0.0362	0.0396	0.0432	0.0468
30	3.8478	0.0245	0.0257	0.0289	0.0321	0.0354	0.0388	0.0423	0.0459
40	3.9264	0.0240	0.0252	0.0283	0.0315	0.0347	0.0381	0.0415	0.0449
50	4.0049	0.0235	0.0247	0.0277	0.0309	0.0340	0.0373	0.0406	0.0441
60	4.0835	0.0230	0.0242	0.0272	0.0303	0.0334	0.0366	0.0399	0.0432
70	4.1621	0.0226	0.0238	0.0267	0.0297	0.0328	0.0359	0.0391	0.0424
80	4.2407	0.0222	0.0233	0.0262	0.0291	0.0322	0.0352	0.0384	0.0416
90	4.3192	0.0218	0.0229	0.0257	0.0286	0.0316	0.0346	0.0377	0.0409
100	4.3978	0.0214	0.0225	0.0253	0.0281	0.0310	0.0340	0.0370	0.0401
110	4.4764	0.0210	0.0221	0.0248	0.0276	0.0305	0.0334	0.0364	0.0394
120	4.5550	0.0207	0.0217	0.0244	0.0271	0.0299	0.0328	0.0357	0.0387
130	4.6336	0.0203	0.0213	0.0240	0.0267	0.0294	0.0322	0.0351	0.0381
140	4.7121	0.0200	0.0210	0.0236	0.0262	0.0289	0.0317	0.0345	0.0375
150	4.7907	0.0196	0.0206	0.0232	0.0258	0.0285	0.0312	0.0340	0.0368
160	4.8693	0.0193	0.0203	0.0228	0.0254	0.0280	0.0307	0.0334	0.0362
170	4.9479	0.0190	0.0200	0.0225	0.0250	0.0276	0.0302	0.0329	0.0357
180	5.0264	0.0187	0.0197	0.0221	0.0246	0.0271	0.0297	0.0324	0.0351
190	5.1050	0.0184	0.0194	0.0218	0.0242	0.0267	0.0293	0.0319	0.0346
200	5.1836	0.0182	0.0191	0.0214	0.0238	0.0263	0.0288	0.0314	0.0340

^aThe manufacturer's listing specifies the temperature range for operation.

^b W/V [agent weight requirements (lb/ft³)] = pounds of agent required per cubic foot of protected volume to produce indicated concentration at temperature specified.

$$W = \frac{V}{s} \left(\frac{C}{100 - C} \right)$$

^c*t* [temperature (°F)] = design temperature in the hazard area.

^d*s* [specific volume (ft³/lb)] = specific volume of HCFC Blend A vapor can be approximated by $s = 3.612 + 0.0079t$, where t = temperature (°F).

^e*C* [concentration (%)] = volumetric concentration of HCFC Blend A in air at the temperature indicated.

- (3) *Fuel geometry considerations.* For Class A and B fires, fuel geometry and compartment obstructions can affect agent concentration at the fire. Full-scale machinery space tests conducted by the Naval Research Laboratory (NRL) have shown that for a large [850 m³ (30,000 ft³)] enclosure with a complex obstructed fuel geometry, agent concentration can vary ±20 percent. Increasing the design concentration or adding or relocating discharge nozzles can compensate for concentrations below the design concentration. For further information, see Naval Research Laboratory Report Ser 6180/0049.2.
- (4) *Enclosure geometry.* Typically in applications involving unusual enclosure geometries, agent distribution is addressed through nozzle placement. If the geometry of the enclosure (or system design) is such that the agent distribution cannot be adequately addressed through nozzle placement, additional concentration should be considered. An example of such applications could be enclosures having very high or very low aspect ratios (length/width).
- (5) *Obstructions within the enclosure.* The following three considerations should be given to enclosure obstructions:
- Room volume should be calculated considering the room empty. Exceptions can be made only for structural components or shafts that pass through the room.
 - For small room volumes, consideration should be given to equipment/storage that take up a considerable percentage of the room volume, specifically, whether the reduced volume will raise the effective concentration of the agent from the NOAEL to the LOAEL in normally occupied spaces. However, this consideration must be closely balanced against the need to maintain an adequate concentration even when the room is empty.

Table A.5.5.1(d) HCFC Blend A Total Flooding Quantity (SI Units)^a

Temp (<i>t</i>) (°C) ^c	Specific Vapor Volume (<i>s</i>) (m ³ /kg) ^d	Weight Requirements of Hazard Volume, <i>W/V</i> (kg/m ³) ^b							
		Design Concentration (% by Volume) ^e							
		8.6	9	10	11	12	13	14	15
-50	0.1971	0.4774	0.5018	0.5638	0.6271	0.6919	0.7582	0.8260	0.8954
-45	0.2015	0.4669	0.4908	0.5514	0.6134	0.6767	0.7415	0.8079	0.8758
-40	0.2059	0.4569	0.4803	0.5396	0.6002	0.6622	0.7256	0.7906	0.8570
-35	0.2103	0.4473	0.4702	0.5283	0.5876	0.6483	0.7104	0.7740	0.8390
-30	0.2148	0.4381	0.4605	0.5174	0.5755	0.6350	0.6958	0.7580	0.8217
-25	0.2192	0.4293	0.4513	0.507	0.5639	0.6222	0.6818	0.7428	0.8052
-20	0.2236	0.4208	0.4423	0.497	0.5528	0.6099	0.6683	0.7281	0.7893
-15	0.2280	0.4127	0.4338	0.4873	0.5421	0.5981	0.6554	0.7140	0.7740
-10	0.2324	0.4048	0.4255	0.4781	0.5318	0.5867	0.6429	0.7004	0.7593
-5	0.2368	0.3973	0.4176	0.4692	0.5219	0.5758	0.6309	0.6874	0.7451
0	0.2412	0.3900	0.4100	0.4606	0.5123	0.5652	0.6194	0.6748	0.7315
5	0.2457	0.3830	0.4026	0.4523	0.5031	0.5551	0.6083	0.6627	0.7183
10	0.2501	0.3762	0.3955	0.4443	0.4942	0.5453	0.5975	0.6510	0.7057
15	0.2545	0.3697	0.3886	0.4366	0.4856	0.5358	0.5871	0.6397	0.6934
20	0.2589	0.3634	0.3820	0.4291	0.4774	0.5267	0.5771	0.6288	0.6816
25	0.2633	0.3573	0.3756	0.422	0.4694	0.5178	0.5675	0.6182	0.6702
30	0.2677	0.3514	0.3694	0.415	0.4616	0.5093	0.5581	0.6080	0.6591
35	0.2722	0.3457	0.3634	0.4083	0.4541	0.5010	0.5490	0.5981	0.6484
40	0.2766	0.3402	0.3576	0.4017	0.4469	0.4930	0.5403	0.5886	0.6381
45	0.2810	0.3349	0.3520	0.3954	0.4399	0.4853	0.5318	0.5793	0.6280
50	0.2854	0.3297	0.3465	0.3893	0.4331	0.4778	0.5236	0.5704	0.6183
55	0.2898	0.3247	0.3412	0.3834	0.4265	0.4705	0.5156	0.5617	0.6089
60	0.2942	0.3198	0.3361	0.3776	0.4201	0.4634	0.5078	0.5533	0.5998
65	0.2987	0.3151	0.3312	0.372	0.4138	0.4566	0.5003	0.5451	0.5909
70	0.3031	0.3105	0.3263	0.3666	0.4078	0.4499	0.4930	0.5371	0.5823
75	0.3075	0.3060	0.3216	0.3614	0.4020	0.4435	0.4860	0.5294	0.5739
80	0.3119	0.3017	0.3171	0.3562	0.3963	0.4372	0.4791	0.5219	0.5658
85	0.3163	0.2975	0.3127	0.3513	0.3907	0.4311	0.4724	0.5146	0.5579
90	0.3207	0.2934	0.3084	0.3464	0.3854	0.4252	0.4659	0.5076	0.5502
95	0.3251	0.2894	0.3042	0.3417	0.3801	0.4194	0.4596	0.5007	0.5427

^aThe manufacturer's listing specifies the temperature range for operation.

^b*W/V* [agent weight requirements (kg/m³)] = kilograms required per cubic meter of protected volume to produce indicated concentration at temperature specified.

$$W = \frac{V}{s} \left(\frac{C}{100 - C} \right)$$

^c*t* [temperature (°C)] = design temperature in the hazard area.

^d*s* [specific volume (m³/kg)] = specific volume of HCFC Blend A vapor can be approximated by $s = 0.2413 + 0.00088t$, where t = temperature (°C).

^e*C* [concentration (%)] = volumetric concentration of HCFC Blend A in air at the temperature indicated.

- (c) Obstructions located near the nozzle could block or impede agent discharge from the nozzle and could affect the distribution of the agent within the enclosure. Obstructions such as ducts, cable trays, large conduits, and light fixtures have the potential to disrupt the flow pattern of the agent from the nozzle. If the flow of the agent is forced down to the floor, for example, it is unlikely that concentration will be achieved at the middle or upper elevations. Certainly, uniform dispersion and concentration will not be achieved.

A.5.5.3.1 The tee design factor is meant to compensate for the uncertainty in the quantity of agent flowing through a pipe as

the agent passes through an increasing number of tees. The listing tests generally incorporate systems with a very limited number of tees (**two to four**). If the number of tees in a system is greater, additional agent is required to compensate for the uncertainty at the tee splits and ensure that a sufficient quantity of agent is delivered to each hazard. Tees that deliver agent only to nozzles within a hazard are not counted for this design factor because it is believed mixing within the hazard will compensate for any discrepancy.

The design factor for the inert gases is less than for the halocarbons because it is believed that the flow of inert gases can be more accurately predicted and that inert gases are less sensitive to pipe variability.

Table A.5.5.1(e) HCFC-124 Total Flooding Quantity (U.S. Units)^a

Temp (<i>t</i>) (°F) ^c	Specific Vapor Volume (<i>s</i>) (ft ³ /lb) ^d	Weight Requirements of Hazard Volume, <i>W/V</i> (lb/ft ³) ^b							
		Design Concentration (% by Volume) ^e							
		5	6	7	8	9	10	11	12
20	2.4643	0.0214	0.0259	0.0305	0.0353	0.0401	0.0451	0.0502	0.0553
30	2.5238	0.0209	0.0253	0.0298	0.0345	0.0392	0.0440	0.0490	0.0540
40	2.5826	0.0204	0.0247	0.0291	0.0337	0.0383	0.0430	0.0479	0.0528
50	2.6409	0.0199	0.0242	0.0285	0.0329	0.0374	0.0421	0.0468	0.0516
60	2.6988	0.0195	0.0237	0.0279	0.0322	0.0366	0.0412	0.0458	0.0505
70	2.7563	0.0191	0.0232	0.0273	0.0315	0.0359	0.0403	0.0448	0.0495
80	2.8136	0.0187	0.0227	0.0268	0.0309	0.0352	0.0395	0.0439	0.0485
90	2.8705	0.0183	0.0222	0.0262	0.0303	0.0345	0.0387	0.0431	0.0475
100	2.9272	0.0180	0.0218	0.0257	0.0297	0.0338	0.0380	0.0422	0.0466
110	2.9837	0.0176	0.0214	0.0252	0.0291	0.0331	0.0372	0.0414	0.0457
120	3.0400	0.0173	0.0210	0.0248	0.0286	0.0325	0.0365	0.0407	0.0449
130	3.0961	0.0170	0.0206	0.0243	0.0281	0.0319	0.0359	0.0399	0.0440
140	3.1520	0.0167	0.0203	0.0239	0.0276	0.0314	0.0353	0.0392	0.0433
150	3.2078	0.0164	0.0199	0.0235	0.0271	0.0308	0.0346	0.0385	0.0425
160	3.2635	0.0161	0.0196	0.0231	0.0266	0.0303	0.0340	0.0379	0.0418
170	3.3191	0.0159	0.0192	0.0227	0.0262	0.0298	0.0335	0.0372	0.0411
180	3.3745	0.0156	0.0189	0.0223	0.0258	0.0293	0.0329	0.0366	0.0404
190	3.4298	0.0153	0.0186	0.0219	0.0254	0.0288	0.0324	0.0360	0.0398
200	3.4850	0.0151	0.0183	0.0216	0.0250	0.0284	0.0319	0.0355	0.0391

^aThe manufacturer's listing specifies the temperature range for operation.

^b W/V [agent weight requirements (lb/ft³)] = pounds of agent required per cubic foot of protected volume to produce indicated concentration at temperature specified.

$$W = \frac{V}{s} \left(\frac{C}{100 - C} \right)$$

^c t [temperature (°F)] = design temperature in the hazard area.

^d s [specific volume (ft³/lb)] = specific volume of HCFC-124 vapor can be approximated by $s = 2.3580 + 0.0057t$ where t = temperature in (°F).

^e C [concentration (%)] = volumetric concentration of HCFC-124 in air at the temperature indicated.

The following two examples illustrate the method for determining the design factor tee count (note that these examples might not represent good design practice):

(1) **Example 1** [see Figure A.5.5.3.1(a)]

Hazard	Design Factor Tee Count
1	9 (tees A, B, C, D, E, F, G, H, I)
2	8 (tees C, D, E, F, G, H, I, A)
3	1 (tee C)

Therefore, if the system uses a halocarbon agent, the design factor is 0.05, and if the system uses an inert gas agent, the design factor is 0.01.

(2) **Example 2** [see Figure A.5.5.3.1(b)]

Hazard	Design Factor Tee Count
1	5 (tees B, C, D, E, F)
2	3 (tees B, E, H)
3	2 (tees E, F)

For Hazard 1, the branch consisting of tees H, I, and J, F is not used because the other branch has a greater tee count.

Therefore, if the system uses a halocarbon agent, the design factor is 0.01, and if the system uses an inert gas agent, the design factor would be 0.00.

A.5.5.3.2 The listing of engineered halon alternative systems requires running a number of tests that include measuring the agent quantity from each nozzle. To successfully pass these tests, the flow calculation software cannot overpredict the measured mass by more than 5 percent nor underpredict the measured mass by more than 10 percent. Experience performing these tests indicates the maximum laboratory accuracy for the calculations is ±5 percent of the measured value with a 90 percent certainty. This means that 90 percent of the measured agent quantities will be within ±5 percent of the predicted value. If the error is due to random factors, then that can be represented statistically by a normal (Gaussian) distribution. A normal distribution curve is shown in Figure A.5.5.3.2(a), with the measured mass normalized by the predicted value. The resulting standard deviation is 0.0304 from standard tables. These systems generally have two tees and three nozzles.

Table A.5.5.1(f) HCFC-124 Total Flooding Quantity (SI Units)^a

Temp (<i>t</i>) (°C) ^c	Specific Vapor Volume (<i>s</i>) (m ³ /kg) ^d	Weight Requirements of Hazard Volume, <i>W/V</i> (kg/m ³) ^b							
		Design Concentration (% by Volume) ^e							
		5	6	7	8	9	10	11	12
-10	0.1516	0.3472	0.4210	0.6524	0.5736	0.6524	0.7329	0.8153	0.1346
-5	0.1550	0.3396	0.4119	0.6382	0.5612	0.6382	0.7170	0.7976	0.1317
0	0.1583	0.3325	0.4032	0.6248	0.5493	0.6248	0.7019	0.7808	0.1289
5	0.1616	0.3257	0.3950	0.6120	0.5381	0.6120	0.6876	0.7649	0.1263
10	0.1649	0.3192	0.3872	0.5999	0.5274	0.5999	0.6739	0.7497	0.1238
15	0.1681	0.3131	0.3797	0.5883	0.5172	0.5883	0.6609	0.7352	0.1214
20	0.1714	0.3071	0.3725	0.5772	0.5074	0.5772	0.6484	0.7213	0.1191
25	0.1746	0.3015	0.3656	0.5665	0.4981	0.5665	0.6364	0.7080	0.1169
30	0.1778	0.2960	0.3590	0.5563	0.4891	0.5563	0.6250	0.6952	0.1148
35	0.1810	0.2908	0.3527	0.5465	0.4805	0.5465	0.6140	0.6830	0.1128
40	0.1842	0.2858	0.3466	0.5371	0.4722	0.5371	0.6034	0.6712	0.1108
45	0.1873	0.2810	0.3408	0.5280	0.4642	0.5280	0.5932	0.6598	0.1089
50	0.1905	0.2763	0.3351	0.5192	0.4565	0.5192	0.5833	0.6489	0.1071
55	0.1936	0.2718	0.3296	0.5108	0.4491	0.5108	0.5738	0.6383	0.1054
60	0.1968	0.2675	0.3244	0.5026	0.4419	0.5026	0.5646	0.6281	0.1037
65	0.1999	0.2633	0.3193	0.4947	0.4350	0.4947	0.5558	0.6183	0.1021
70	0.2030	0.2592	0.3144	0.4871	0.4283	0.4871	0.5472	0.6087	0.1005
75	0.2062	0.2553	0.3096	0.4797	0.4218	0.4797	0.5390	0.5995	0.0990
80	0.2093	0.2515	0.3050	0.4726	0.4155	0.4726	0.5309	0.5906	0.0975
85	0.2124	0.2478	0.3005	0.4657	0.4094	0.4657	0.5231	0.5819	0.0961
90	0.2155	0.2442	0.2962	0.4589	0.4035	0.4589	0.5156	0.5735	0.0947
95	0.2186	0.2408	0.2920	0.4524	0.3978	0.4524	0.5083	0.5654	0.0934

^aThe manufacturer's listing specifies the temperature range for operation.

^b*W/V* [agent weight requirements (kg/m³)] = kilograms of agent required per cubic meter of protected volume to produce indicated concentration at temperature specified.

$$W = \frac{V}{s} \left(\frac{C}{100 - C} \right)$$

^c*t* [temperature (°C)] = design temperature in the hazard area.

^d*s* [specific volume (m³/kg)] = specific volume of HCFC-124 vapor can be approximated by $s = 0.1585 + 0.0006t$, where *t* is the temperature (°C).

^e*C* [concentration (%)] = volumetric concentration of HCFC-124 in air at the temperature indicated.

For a system that utilizes more than two tees, the error will propagate and the certainty for the prediction of the agent quantity will be less. The more tees between a nozzle and the cylinder, the lower the certainty. This propagation of error can be calculated and results in a new normal distribution with a greater standard deviation. This can be calculated for any number of tees. For example, the standard deviation for a system with eight tees would be 0.0608.

For the purpose of this standard, the uncertainty for the prediction for an installed system is limited to having at least 99 percent of the nozzles deliver at least 90 percent of the predicted agent quantity. This implies not "using up" more than one-half of the 20 percent safety factor for 99 percent of the nozzles. For a normal distribution with a standard deviation of 0.0608, the tail area representing 1 percent of the systems occurs at a normalized mass value of 0.859.

It is apparent that significantly more than 1 percent of the systems will have less than 90 percent of the predicted mass delivered. To rectify this situation, more agent should be used in the system, which would move the entire probability curve up. The quantity of agent that would need to be added is as follows:

$$0.90 - 0.859 = 0.041, \text{ or } 4.1 \text{ percent}$$

The addition of 4.1 percent more agent would ensure that 99 percent of the nozzles deliver at least 90 percent of the required mass of agent.

The analysis for Table 5.5.3.1 was performed for up to 19 tees, 20 nozzles, in a system. [See Figure A.5.5.3.2(b) through Figure A.5.5.3.2(g).]

A.5.5.3.3 Some areas affected by pressures other than sea level include hyperbaric enclosures; facilities where ventilation fans are used to create artificially higher or lower pressures, such as test chambers; and facilities at altitudes above or below sea level. Although mines are usually below normal ground levels, they occasionally have to be ventilated so that personnel can work in that environment. Ambient pressures in that situation can be considerably different from those expected by a pure altitude correction.

Although adjustments are required for barometric pressures equivalent to 3000 ft (915 m) or more above or below sea level, adjustments can be made for any ambient pressure condition.

Table A.5.5.1(g) HFC-125 Total Flooding Quantity (U.S. Units)^a

Temp (<i>t</i>) (°F) ^c	Specific Vapor Volume (<i>s</i>) (ft ³ /lb) ^d	Weight Requirements of Hazard Volume, <i>W/V</i> (lb/ft ³) ^b									
		Design Concentration (% by Volume) ^e									
		7	8	9	10	11	12	13	14	15	16
-50	2.3902	0.0315	0.0364	0.0414	0.0465	0.0517	0.0571	0.0625	0.0681	0.0738	0.0797
-40	2.4577	0.0306	0.0354	0.0402	0.0452	0.0503	0.0555	0.0608	0.0662	0.0718	0.0775
-30	2.5246	0.0298	0.0344	0.0392	0.0440	0.0490	0.0540	0.0592	0.0645	0.0699	0.0754
-20	2.5909	0.0291	0.0336	0.0382	0.0429	0.0477	0.0526	0.0577	0.0628	0.0681	0.0735
-10	2.6568	0.0283	0.0327	0.0372	0.0418	0.0465	0.0513	0.0562	0.0613	0.0664	0.0717
0	2.7222	0.0276	0.0319	0.0363	0.0408	0.0454	0.0501	0.0549	0.0598	0.0648	0.0700
10	2.7872	0.0270	0.0312	0.0355	0.0399	0.0443	0.0489	0.0536	0.0584	0.0633	0.0683
20	2.8518	0.0264	0.0305	0.0347	0.0390	0.0433	0.0478	0.0524	0.0571	0.0619	0.0668
30	2.9162	0.0258	0.0298	0.0339	0.0381	0.0424	0.0468	0.0512	0.0558	0.0605	0.0653
40	2.9803	0.0253	0.0292	0.0332	0.0373	0.0415	0.0458	0.0501	0.0546	0.0592	0.0639
50	3.0441	0.0247	0.0286	0.0325	0.0365	0.0406	0.0448	0.0491	0.0535	0.0580	0.0626
60	3.1077	0.0242	0.0280	0.0318	0.0358	0.0398	0.0439	0.0481	0.0524	0.0568	0.0613
70	3.1712	0.0237	0.0274	0.0312	0.0350	0.0390	0.0430	0.0471	0.0513	0.0556	0.0601
80	3.2344	0.0233	0.0269	0.0306	0.0344	0.0382	0.0422	0.0462	0.0503	0.0546	0.0589
90	3.2975	0.0228	0.0264	0.0300	0.0337	0.0375	0.0414	0.0453	0.0494	0.0535	0.0578
100	3.3605	0.0224	0.0259	0.0294	0.0331	0.0368	0.0406	0.0445	0.0484	0.0525	0.0567
110	3.4233	0.0220	0.0254	0.0289	0.0325	0.0361	0.0398	0.0436	0.0476	0.0515	0.0556
120	3.4859	0.0216	0.0249	0.0284	0.0319	0.0355	0.0391	0.0429	0.0467	0.0506	0.0546
130	3.5485	0.0212	0.0245	0.0279	0.0313	0.0348	0.0384	0.0421	0.0459	0.0497	0.0537
140	3.6110	0.0208	0.0241	0.0274	0.0308	0.0342	0.0378	0.0414	0.0451	0.0489	0.0527
150	3.6734	0.0205	0.0237	0.0269	0.0302	0.0336	0.0371	0.0407	0.0443	0.0480	0.0519
160	3.7357	0.0201	0.0233	0.0265	0.0297	0.0331	0.0365	0.0400	0.0436	0.0472	0.0510
170	3.7979	0.0198	0.0229	0.0260	0.0293	0.0325	0.0359	0.0393	0.0429	0.0465	0.0502
180	3.8600	0.0195	0.0225	0.0256	0.0288	0.0320	0.0353	0.0387	0.0422	0.0457	0.0493
190	3.9221	0.0192	0.0222	0.0252	0.0283	0.0315	0.0348	0.0381	0.0415	0.0450	0.0486
200	3.9841	0.0189	0.0218	0.0248	0.0279	0.0310	0.0342	0.0375	0.0409	0.0443	0.0478

^aThe manufacturer's listing specifies the temperature range for operation.

^b W/V [agent weight requirements (lb/ft³)] = pounds of agent required per cubic foot of protected volume to produce indicated concentration at temperature specified.

$$W = \frac{V}{s} \left(\frac{C}{100 - C} \right)$$

^c t [temperature (°F)] = design temperature in the hazard area.

^d s [specific volume (ft³/lb)] = specific volume of HFC-125 vapor can be approximated $s = 2.7208 + 0.0064t$, where t = temperature (°F).

^e C [concentration (%)] = volumetric concentration of HFC-125 in air at the temperature indicated.

The atmospheric correction factor is not linear. However, in the moderate range discussed, it can be closely approximated with two lines:

For 3000 ft to 5500 ft of equivalent altitude:

[A.5.5.3.3a]

$$Y = (-0.000036 \times X) + 1$$

For 5501 ft to 10,000 ft of equivalent altitude:

[A.5.5.3.3b]

$$Y = (-0.00003 \times X) + 0.96$$

where:

Y = correction factor

X = altitude (ft)

For SI units, 1 ft = 0.305 m.

The increase, from the 1996 edition to this edition, in safety factor for manually actuated systems and systems protecting Class B hazards, is intended to account for the uncertainty in minimum design concentration associated with these types of systems and hazards.

The presence of hot metal surfaces, large fire sizes, increased fuel temperatures, and other variables associated with longer pre-burn times can increase the minimum extinguishing concentration needed for these types of fires. In addition, the increased safety factor will serve to reduce decomposition product formation for halocarbon agents in the presence of larger fires expected in manually operated systems and Class B hazards.

There have been no reported system failures associated with these types of fires in fueled installations, and successful extinguishment events have been reported for systems designed and installed in accordance with previous editions of this standard.

▲ Table A.5.1(h) HFC-125 Total Flooding Quantity (SI Units)^a

Temp (<i>t</i>) (°C) ^c	Specific Vapor Volume (<i>s</i>) (m ³ /kg) ^d	Weight Requirements of Hazard Volume, <i>W/V</i> (kg/m ³) ^b									
		Design Concentration (% by Volume) ^e									
		7	8	9	10	11	12	13	14	15	16
-45	0.1496	0.5030	0.5811	0.6609	0.7425	0.8260	0.9113	0.9986	1.0879	1.1793	1.2729
-40	0.1534	0.4906	0.5668	0.6446	0.7242	0.8055	0.8888	0.9739	1.0610	1.1502	1.2415
-35	0.1572	0.4788	0.5532	0.6292	0.7069	0.7863	0.8675	0.9506	1.0356	1.1227	1.2118
-30	0.1609	0.4677	0.5404	0.6146	0.6905	0.7681	0.8474	0.9286	1.0116	1.0966	1.1837
-25	0.1646	0.4572	0.5282	0.6007	0.6749	0.7507	0.8283	0.9076	0.9888	1.0719	1.1570
-20	0.1683	0.4472	0.5166	0.5876	0.6602	0.7343	0.8102	0.8878	0.9672	1.0485	1.1317
-15	0.1720	0.4377	0.5056	0.5751	0.6461	0.7187	0.7930	0.8689	0.9466	1.0262	1.1076
-10	0.1756	0.4286	0.4952	0.5632	0.6327	0.7038	0.7765	0.8509	0.9270	1.0049	1.0847
-5	0.1792	0.4199	0.4851	0.5518	0.6199	0.6896	0.7608	0.8337	0.9082	0.9845	1.0627
0	0.1829	0.4116	0.4756	0.5409	0.6077	0.6759	0.7458	0.8172	0.8903	0.9651	1.0417
5	0.1865	0.4037	0.4664	0.5304	0.5959	0.6629	0.7314	0.8014	0.8731	0.9465	1.0216
10	0.1900	0.3961	0.4576	0.5204	0.5847	0.6504	0.7176	0.7863	0.8566	0.9286	1.0023
15	0.1936	0.3888	0.4491	0.5108	0.5739	0.6384	0.7043	0.7718	0.8408	0.9115	0.9838
20	0.1972	0.3817	0.4410	0.5016	0.5635	0.6268	0.6916	0.7578	0.8256	0.8950	0.9660
25	0.2007	0.3750	0.4332	0.4927	0.5535	0.6157	0.6793	0.7444	0.8110	0.8791	0.9489
30	0.2043	0.3685	0.4257	0.4841	0.5439	0.6050	0.6675	0.7315	0.7969	0.8639	0.9324
35	0.2078	0.3622	0.4184	0.4759	0.5347	0.5947	0.6562	0.7190	0.7833	0.8492	0.9165
40	0.2114	0.3561	0.4114	0.4679	0.5257	0.5848	0.6452	0.7070	0.7702	0.8349	0.9012
45	0.2149	0.3503	0.4047	0.4603	0.5171	0.5752	0.6346	0.6954	0.7576	0.8213	0.8864
50	0.2184	0.3446	0.3982	0.4528	0.5088	0.5659	0.6244	0.6842	0.7454	0.8080	0.8721
55	0.2219	0.3392	0.3918	0.4457	0.5007	0.5569	0.6145	0.6733	0.7336	0.7952	0.8583
60	0.2254	0.3339	0.3857	0.4387	0.4929	0.5483	0.6049	0.6628	0.7221	0.7828	0.8449
65	0.2289	0.3288	0.3798	0.4320	0.4853	0.5399	0.5957	0.6527	0.7111	0.7708	0.8320
70	0.2324	0.3238	0.3741	0.4255	0.4780	0.5318	0.5867	0.6429	0.7004	0.7592	0.8195
75	0.2359	0.3190	0.3686	0.4192	0.4709	0.5239	0.5780	0.6333	0.6900	0.7480	0.8073
80	0.2394	0.3144	0.3632	0.4131	0.4641	0.5162	0.5696	0.6241	0.6799	0.7371	0.7956
85	0.2429	0.3099	0.3580	0.4072	0.4574	0.5088	0.5614	0.6151	0.6702	0.7265	0.7841
90	0.2464	0.3055	0.3529	0.4014	0.4509	0.5016	0.5534	0.6064	0.6607	0.7162	0.7730
95	0.2499	0.3012	0.3480	0.3958	0.4447	0.4946	0.5457	0.5980	0.6515	0.7062	0.7623

^aThe manufacturer's listing specifies the temperature range for operation.

^b*W/V* [agent weight requirements (kg/m³)] = kilograms required per cubic meter of protected volume to produce indicated concentration at temperature specified.

$$W = \frac{V}{s} \left(\frac{C}{100 - C} \right)$$

^c*t* [temperature (°C)] = design temperature in the hazard area.

^d*s* [specific volume (m³/kg)] = specific volume of HFC-125 vapor can be approximated $s = 0.1826 + 0.0007t$, where *t* = temperature (°C).

^e*C* [concentration (%)] = volumetric concentration of HFC-125 in air at the temperature indicated.

This change is intended to enhance the overall effectiveness of new clean agent systems and is based on theoretical and laboratory experience. This change in safety factor does not apply to existing systems. Field experience indicates that any existing system designed with a 20 percent safety factor will perform as intended.

The ambient pressure is affected by changes in altitude, pressurization or depressurization of the protected enclosure, and weather-related barometric pressure changes. The design factor to account for cases where the pressure of the protected hazard is different from atmospheric pressure is computed as the ratio of the nominal absolute pressure within the hazard divided by the average atmospheric pressure at sea level [14.7 psia/(1 bar)].

A.5.6 In establishing the hold time, designers and authorities having jurisdiction should consider the following or other unique factors that can influence the performance of the suppression system:

- (1) Response time of trained personnel
- (2) Sources of persistent ignition
- (3) Excessive enclosure leakage
- (4) System enclosure venting requirements
- (5) Inertion and reflash hazards
- (6) Winddown of rotating equipment

The hold time for the duration of protection should be sufficient to control the initial event and allow for support should resurgence occur once the agent has dissipated.

Table A.5.5.1(i) HFC-227ea Total Flooding Quantity (U.S. Units)^a

Temp (<i>t</i>) (°F) ^c	Specific Vapor Volume (<i>s</i>) (ft ³ /lb) ^d	Weight Requirements of Hazard Volume, <i>W/V</i> (lb/ft ³) ^b									
		Design Concentration (% by Volume) ^e									
		6	7	8	9	10	11	12	13	14	15
10	1.9264	0.0331	0.0391	0.0451	0.0513	0.0570	0.0642	0.0708	0.0776	0.0845	0.0916
20	1.9736	0.0323	0.0381	0.0441	0.0501	0.0563	0.0626	0.0691	0.0757	0.0825	0.0894
30	2.0210	0.0316	0.0372	0.0430	0.0489	0.0550	0.0612	0.0675	0.0739	0.0805	0.0873
40	2.0678	0.0309	0.0364	0.0421	0.0478	0.0537	0.0598	0.0659	0.0723	0.0787	0.0853
50	2.1146	0.0302	0.0356	0.0411	0.0468	0.0525	0.0584	0.0645	0.0707	0.0770	0.0835
60	2.1612	0.0295	0.0348	0.0402	0.0458	0.0514	0.0572	0.0631	0.0691	0.0753	0.0817
70	2.2075	0.0289	0.0341	0.0394	0.0448	0.0503	0.0560	0.0618	0.0677	0.0737	0.0799
80	2.2538	0.0283	0.0334	0.0386	0.0439	0.0493	0.0548	0.0605	0.0663	0.0722	0.0783
90	2.2994	0.0278	0.0327	0.0378	0.0430	0.0483	0.0538	0.0593	0.0650	0.0708	0.0767
100	2.3452	0.0272	0.0321	0.0371	0.0422	0.0474	0.0527	0.0581	0.0637	0.0694	0.0752
110	2.3912	0.0267	0.0315	0.0364	0.0414	0.0465	0.0517	0.0570	0.0625	0.0681	0.0738
120	2.4366	0.0262	0.0309	0.0357	0.0406	0.0456	0.0507	0.0560	0.0613	0.0668	0.0724
130	2.4820	0.0257	0.0303	0.0350	0.0398	0.0448	0.0498	0.0549	0.0602	0.0656	0.0711
140	2.5272	0.0253	0.0298	0.0344	0.0391	0.0440	0.0489	0.0540	0.0591	0.0644	0.0698
150	2.5727	0.0248	0.0293	0.0338	0.0384	0.0432	0.0480	0.0530	0.0581	0.0633	0.0686
160	2.6171	0.0244	0.0288	0.0332	0.0378	0.0425	0.0472	0.0521	0.0571	0.0622	0.0674
170	2.6624	0.0240	0.0283	0.0327	0.0371	0.0417	0.0464	0.0512	0.0561	0.0611	0.0663
180	2.7071	0.0236	0.0278	0.0321	0.0365	0.0410	0.0457	0.0504	0.0552	0.0601	0.0652
190	2.7518	0.0232	0.0274	0.0316	0.0359	0.0404	0.0449	0.0496	0.0543	0.0592	0.0641
200	2.7954	0.0228	0.0269	0.0311	0.0354	0.0397	0.0442	0.0488	0.0535	0.0582	0.0631

^aThe manufacturer's listing specifies the temperature range for operation.

^b W/V [agent weight requirements (lb/ft³)] = pounds of agent required per cubic foot of protected volume to produce indicated concentration at temperature specified.

$$W = \frac{V}{s} \left(\frac{C}{100 - C} \right)$$

^c*t* [temperature (°F)] = design temperature in the hazard area.

^d*s* [specific volume (ft³/lb)] = specific volume of HFC-227ea vapor can be approximated by $s = 1.885 + 0.0046t$, where t = temperature (°F).

^e*C* [concentration (%)] = volumetric concentration of HFC-227ea in air at the temperature indicated.

Energized electrical equipment that could provide a prolonged ignition source should be de-energized prior to or during agent discharge.

If electrical equipment cannot be de-energized, consideration should be given to the use of extended agent discharge, higher initial concentration, and the possibility of the formation of combustion and decomposition products. Additional testing can be needed on suppression of energized electrical equipment fires to determine these quantities.

A.5.6.1 This is equally important in all classes of fires, since a persistent ignition source (e.g., an arc, heat source, oxyacetylene torch, or "deep-seated" fire) can lead to resurgence of the initial event once the clean agent has dissipated.

A.5.7.1.1 The optimum discharge time is a function of many variables, five of which are very important:

- (1) Limitation of decomposition products
- (2) Limitation of fire damage and its effects
- (3) Enhanced agent mixing
- (4) Limitation of compartment overpressure
- (5) Secondary nozzle effects

It is essential for the end user to understand that both the products of combustion and the decomposition products

formed from the suppression agent contribute to the total threat to life or assets associated with a fire.

Essentially all fires will produce carbon monoxide and carbon dioxide, and the contribution of these products to the toxic threat posed by the fire event is well known. In the case of large fires, the high temperatures can by themselves lead to life- and asset-threatening conditions. In addition, most fires produce smoke, and it is well documented that damage to sensitive assets can occur at very low levels of smoke. Depending upon the particular fuel involved, numerous toxic products of combustion can be produced in a fire (e.g., HCl, HBr, HF, HCN, CO).

The halogenated hydrocarbon fire extinguishing agents described in this standard will break down into their decomposition products when they are exposed to a fire. It is essential that the end user understand this process, since the selection of the discharge time and other design factors will be affected by the amount of decomposition products the protected hazard can tolerate.

The concentration of thermal decomposition products from a halogenated fire suppression agent is dependent on several factors. The size of the fire at the time of system activation and the discharge time of the suppression agent play major roles in

△ Table A.5.5.1(j) HFC-227ea Total Flooding Quantity (SI Units)^a

Temp (<i>t</i>) (°C) ^c	Specific Vapor Volume (<i>s</i>) (m ³ /kg) ^d	Weight Requirements of Hazard Volume, <i>W/V</i> (kg/m ³) ^b									
		Design Concentration (% per Volume) ^e									
		6	7	8	9	10	11	12	13	14	15
-10	0.1215	0.5254	0.6196	0.7158	0.8142	0.9147	1.0174	1.1225	1.2301	1.3401	1.4527
-5	0.1241	0.5142	0.6064	0.7005	0.7987	0.8951	0.9957	1.0985	1.2038	1.3114	1.4216
0	0.1268	0.5034	0.5936	0.6858	0.7800	0.8763	0.9748	1.0755	1.1785	1.2839	1.3918
5	0.1294	0.4932	0.5816	0.6719	0.7642	0.8586	0.9550	1.0537	1.1546	1.2579	1.3636
10	0.1320	0.4834	0.5700	0.6585	0.7490	0.8414	0.9360	1.0327	1.1316	1.2328	1.3264
15	0.1347	0.4740	0.5589	0.6457	0.7344	0.8251	0.9178	1.0126	1.1096	1.2089	1.3105
20	0.1373	0.4650	0.5483	0.6335	0.7205	0.8094	0.9004	0.9934	1.0886	1.1859	1.2856
25	0.1399	0.4564	0.5382	0.6217	0.7071	0.7944	0.8837	0.9750	1.0684	1.1640	1.2618
30	0.1425	0.4481	0.5284	0.6104	0.6943	0.7800	0.8676	0.9573	1.0490	1.1428	1.2388
35	0.1450	0.4401	0.5190	0.5996	0.6819	0.7661	0.8522	0.9402	1.0303	1.1224	1.2168
40	0.1476	0.4324	0.5099	0.5891	0.6701	0.7528	0.8374	0.9230	1.0124	1.1029	1.1956
45	0.1502	0.4250	0.5012	0.5790	0.6586	0.7399	0.8230	0.9080	0.9950	1.0840	1.1751
50	0.1527	0.4180	0.4929	0.5694	0.6476	0.7276	0.8093	0.8929	0.9784	1.0660	1.1555
55	0.1553	0.4111	0.4847	0.5600	0.6369	0.7156	0.7960	0.8782	0.9623	1.0484	1.1365
60	0.1578	0.4045	0.4770	0.5510	0.6267	0.7041	0.7832	0.8641	0.9469	1.0316	1.1183
65	0.1604	0.3980	0.4694	0.5423	0.6167	0.6929	0.7707	0.8504	0.9318	1.0152	1.1005
70	0.1629	0.3919	0.4621	0.5338	0.6072	0.6821	0.7588	0.8371	0.9173	0.9994	1.0834
75	0.1654	0.3859	0.4550	0.5257	0.5979	0.6717	0.7471	0.8243	0.9033	0.9841	1.0668
80	0.1679	0.3801	0.4482	0.5178	0.5890	0.6617	0.7360	0.8120	0.8898	0.9694	1.0509
85	0.1704	0.3745	0.4416	0.5102	0.5803	0.6519	0.7251	0.8000	0.8767	0.9551	1.0354
90	0.1730	0.3690	0.4351	0.5027	0.5717	0.6423	0.7145	0.7883	0.8638	0.9411	1.0202

^aThe manufacturer's listing specifies the temperature range for operation.

^b W/V [agent weight requirements (kg/m³)] = kilograms of agent per cubic meter of protected volume to produce indicated concentration at temperature specified.

$$W = \frac{V}{s} \left(\frac{C}{100 - C} \right)$$

^c t [temperature (°C)] = design temperature in the hazard area.

^d s [specific volume (m³/kg)] = specific volume of HFC-227ea vapor can be approximated by $s = 0.1269 + 0.0005t$, where t = temperature (°C).

^e C [concentration (%)] = volumetric concentration of HFC-227ea in air at the temperature indicated.

determining the amount of decomposition products formed. The smaller the fire, the less energy (heat) is available to cause thermal decomposition of the suppression agent, and hence the lower the concentration of thermal decomposition products. The size of the fire at the time of system activation is dependent upon the fire growth rate, the detector sensitivity, and the system discharge delay time. The first factor is primarily a function of the fuel type and geometry, whereas the latter two are adjustable characteristics of the fire protection system. The discharge time affects the production of thermal decomposition products, because it determines the exposure time to the fire of sub-extinguishing concentrations of the fire suppression agent. Suppression systems have traditionally employed a combination of rapid detection and rapid discharge to limit both the production of thermal decomposition products and damage to assets by providing rapid flame extinguishment.

The enclosure volume also affects the concentration of thermal decomposition products, since larger volumes, that is, smaller fire-size-to-room-volume ratios, will lead to dilution of decomposition products. Additional factors affecting the concentration of thermal decomposition products include vaporization and mixing of the agent, the pre-burn time, the presence of hot surfaces or deep-seated fires, and the suppression agent concentration.

This decomposition issue is not unique to the new clean halogenated agents. The thermal decomposition products resulting from the extinguishment of fires with Halon 1301 have been investigated by numerous authors (e.g., Ford, 1972, and Cholin, 1972), and it is well established that the most important Halon 1301 thermal decomposition products from the standpoint of potential toxicity to humans or potential corrosion of electronic equipment are the halogen acids HF and HBr. Concentrations of acid halides produced from Halon 1301 ranging from a few parts per million to over 7000 ppm HF and HBr have been reported, depending upon the exact nature of the fire scenario (Sheinson et al., 1981). Smaller amounts of additional decomposition products can be produced, depending upon the particular conditions of the fire. Under certain conditions, thermal decomposition of Halon 1301 in a fire has been reported to produce small amounts of carbonyl fluoride (COF₂), carbonyl bromide (COBr₂), and bromine (Br₂), in addition to relatively large amounts of HF and HBr. Note that all of these products are subject to relatively rapid hydrolysis to form the acid halides HF and HBr (Cotton and Wilkinson, 1980), and hence these acids constitute the product of primary concern from the standpoint of potential toxicity or corrosion.

▲ Table A.5.5.1(k) HFC-23 Total Flooding Quantity (U.S. Units)^a

Temp (t) (°F) ^c	Specific Vapor Volume (s) (ft ³ /lb) ^d	Weight Requirements of Hazard Volume, W/V (lb/ft ³) ^b									
		Design Concentration (% by Volume) ^e									
		10	12	14	15	16	17	18	19	20	22
-70	3.9636	0.0280	0.0344	0.0411	0.0445	0.0481	0.0517	0.0554	0.0592	0.0631	0.0712
-60	4.0752	0.0273	0.0335	0.0399	0.0433	0.0467	0.0503	0.0539	0.0576	0.0613	0.0692
-50	4.1859	0.0265	0.0326	0.0389	0.0422	0.0455	0.0489	0.0524	0.0560	0.0597	0.0674
-40	4.2959	0.0259	0.0317	0.0379	0.0411	0.0443	0.0477	0.0511	0.0546	0.0582	0.0657
-30	4.4053	0.0252	0.0310	0.0370	0.0401	0.0432	0.0465	0.0498	0.0532	0.0567	0.0640
-20	4.5151	0.0246	0.0302	0.0361	0.0391	0.0422	0.0454	0.0486	0.0520	0.0554	0.0625
-10	4.6225	0.0240	0.0295	0.0352	0.0382	0.0412	0.0443	0.0475	0.0507	0.0541	0.0610
0	4.7305	0.0235	0.0288	0.0344	0.0373	0.0403	0.0433	0.0464	0.0496	0.0528	0.0596
10	4.8383	0.0230	0.0282	0.0336	0.0365	0.0394	0.0423	0.0454	0.0485	0.0517	0.0583
20	4.9457	0.0225	0.0276	0.0329	0.0357	0.0385	0.0414	0.0444	0.0474	0.0505	0.0570
30	5.0529	0.0220	0.0270	0.0322	0.0349	0.0377	0.0405	0.0434	0.0464	0.0495	0.0558
40	5.1599	0.0215	0.0264	0.0315	0.0342	0.0369	0.0397	0.0425	0.0455	0.0485	0.0547
50	5.2666	0.0211	0.0259	0.0309	0.0335	0.0362	0.0389	0.0417	0.0445	0.0475	0.0536
60	5.3733	0.0207	0.0254	0.0303	0.0328	0.0354	0.0381	0.0409	0.0437	0.0465	0.0525
70	5.4797	0.0203	0.0249	0.0297	0.0322	0.0348	0.0374	0.0401	0.0428	0.0456	0.0515
80	5.5860	0.0199	0.0244	0.0291	0.0316	0.0341	0.0367	0.0393	0.0420	0.0448	0.0505
90	5.6922	0.0195	0.0240	0.0286	0.0310	0.0335	0.0360	0.0386	0.0412	0.0439	0.0496
100	5.7983	0.0192	0.0235	0.0281	0.0304	0.0329	0.0353	0.0379	0.0405	0.0431	0.0486
110	5.9043	0.0188	0.0231	0.0276	0.0299	0.0323	0.0347	0.0372	0.0397	0.0423	0.0478
120	6.0102	0.0185	0.0227	0.0271	0.0294	0.0317	0.0341	0.0365	0.0390	0.0416	0.0469
130	6.1160	0.0182	0.0223	0.0266	0.0289	0.0311	0.0335	0.0359	0.0384	0.0409	0.0461
140	6.2217	0.0179	0.0219	0.0262	0.0284	0.0306	0.0329	0.0353	0.0377	0.0402	0.0453
150	6.3274	0.0176	0.0216	0.0257	0.0279	0.0301	0.0324	0.0347	0.0371	0.0395	0.0446
160	6.4330	0.0173	0.0212	0.0253	0.0274	0.0296	0.0318	0.0341	0.0365	0.0389	0.0438
170	6.5385	0.0170	0.0209	0.0249	0.0270	0.0291	0.0313	0.0336	0.0359	0.0382	0.0431
180	6.6440	0.0167	0.0205	0.0245	0.0266	0.0287	0.0308	0.0330	0.0353	0.0376	0.0424
190	6.7494	0.0165	0.0202	0.0241	0.0261	0.0282	0.0303	0.0325	0.0348	0.0370	0.0418

^aThe manufacturer's listing specifies the temperature range for operation.

^bW/V [agent weight requirements (lb/ft³)] = pounds of agent required per cubic foot of protected volume to produce indicated concentration at temperature specified.

$$W = \frac{V}{s} \left(\frac{C}{100 - C} \right)$$

^ct [temperature (°F)] = design temperature in the hazard area.

^ds [specific volume (ft³/lb)] = specific volume of HFC-23 vapor can be approximated by $s = 4.7264 + 0.0107t$, where t = temperature (°F).

^eC [concentration (%)] = volumetric concentration of HFC-23 in air at the temperature indicated.

As was the case for Halon 1301, the thermal decomposition products of primary concern for the halogenated agents described in this standard are the associated halogen acids, HF in the case of HFCs and PFCs, HF and HCl in the case of HCFC agents, and HF and HI in the case of I-containing agents. As was the case for Halon 1301, smaller amounts of other decomposition products can be produced, depending upon the particular conditions of the fire. In a fire, HFC or PFC agents can potentially produce small amounts of carbonyl fluoride (COF₂). HCFC agents can potentially produce carbonyl fluoride (COF₂), carbonyl chloride (COCl₂), and elemental chlorine (Cl₂), and I-containing compounds can potentially produce carbonyl fluoride (COF₂) and elemental iodine (I₂). All of these products are subject to relatively rapid hydrolysis (Cotton and Wilkinson, 1980) to produce the associated halogen acid (HF, HCl, or HI); hence, from the standpoint of potential toxicity to humans or potential corrosion of electronic equip-

ment, the halogen acids are the decomposition products of concern.

The dependence of decomposition product formation on the discharge time and fire size has been extensively evaluated (Sheinson et al., 1994; Brockway, 1994; Moore et al., 1993; Back et al., 1994; Forssell and DiNunno, 1995; DiNunno, 1993; Purser, 1998; and Dierdorf et al., 1993). Figure A.5.7.1.1(a) is a plot of peak HF concentration as a function of the fire-size-to-room-volume ratio. The data encompass room scales of 1.2 m³ (42 ft³) to 972 m³ (34,326 ft³). The 526 m³ results are from U.S. Coast Guard (USCG) testing; the 972 m³ results are based on NRL testing. These fires include diesel and heptane pool and spray fires. The design concentration in all cases except HCFC Blend A (at 8.6 percent) are at least 20 percent above the cup burner value. For fires where the extinguishment times were greater than 17 seconds, the extinguishment time is noted in

Table A.5.5.1(l) HFC-23 Total Flooding Quantity (SI Units)^a

Temp (<i>t</i>) (°C) ^c	Specific Vapor Volume (<i>s</i>) (m ³ /kg) ^d	Weight Requirements of Hazard Volume, <i>W/V</i> (kg/m ³) ^b										
		Design Concentration (% by Volume) ^e										
		10	12	14	15	16	17	18	19	20	22	24
-60	0.2432	0.4568	0.5606	0.6693	0.7255	0.7831	0.8421	0.9025	0.9644	1.0278	1.1596	1.2983
-55	0.2495	0.4453	0.5465	0.6524	0.7072	0.7633	0.8208	0.8797	0.9400	1.0018	1.1303	1.2655
-50	0.2558	0.4344	0.5331	0.6364	0.6899	0.7446	0.8007	0.8581	0.9170	0.9773	1.1026	1.2345
-45	0.2620	0.4241	0.5205	0.6213	0.6735	0.7270	0.7817	0.8378	0.8953	0.9542	1.0765	1.2053
-40	0.2682	0.4143	0.5085	0.6070	0.6580	0.7102	0.7637	0.8185	0.8746	0.9322	1.0517	1.1775
-35	0.2743	0.4050	0.4971	0.5934	0.6433	0.6943	0.7466	0.8002	0.8551	0.9113	1.0281	1.1511
-30	0.2805	0.3962	0.4862	0.5805	0.6292	0.6792	0.7303	0.7827	0.8364	0.8914	1.0057	1.1260
-25	0.2866	0.3878	0.4759	0.5681	0.6158	0.6647	0.7148	0.7661	0.8186	0.8724	0.9843	1.1020
-20	0.2926	0.3797	0.4660	0.5563	0.6031	0.6509	0.6999	0.7502	0.8016	0.8544	0.9639	1.0792
-15	0.2987	0.3720	0.4566	0.5450	0.5908	0.6377	0.6857	0.7349	0.7853	0.8370	0.9443	1.0573
-10	0.3047	0.3646	0.4475	0.5342	0.5791	0.6251	0.6721	0.7203	0.7698	0.8204	0.9256	1.0363
-5	0.3108	0.3575	0.4388	0.5238	0.5679	0.6129	0.6591	0.7064	0.7548	0.8045	0.9076	1.0162
0	0.3168	0.3508	0.4305	0.5139	0.5571	0.6013	0.6466	0.6929	0.7405	0.7892	0.8904	0.9969
5	0.3228	0.3442	0.4225	0.5043	0.5467	0.5901	0.6345	0.6800	0.7267	0.7745	0.8738	0.9783
10	0.3288	0.3379	0.4147	0.4951	0.5367	0.5793	0.6229	0.6676	0.7134	0.7604	0.8578	0.9605
15	0.3348	0.3319	0.4073	0.4863	0.5271	0.5690	0.6118	0.6557	0.7007	0.7468	0.8425	0.9433
20	0.3408	0.3261	0.4002	0.4777	0.5179	0.5590	0.6011	0.6442	0.6884	0.7337	0.8277	0.9267
25	0.3467	0.3204	0.3933	0.4695	0.5089	0.5493	0.5907	0.6331	0.6765	0.7210	0.8134	0.9107
30	0.3527	0.3150	0.3866	0.4616	0.5003	0.5401	0.5807	0.6224	0.6651	0.7088	0.7997	0.8953
35	0.3587	0.3098	0.3802	0.4539	0.4920	0.5311	0.5711	0.6120	0.6540	0.6970	0.7864	0.8804
40	0.3646	0.3047	0.3740	0.4465	0.4840	0.5224	0.5617	0.6020	0.6433	0.6856	0.7735	0.8661
45	0.3706	0.2998	0.3680	0.4393	0.4762	0.5140	0.5527	0.5923	0.6330	0.6746	0.7611	0.8521
50	0.3765	0.2951	0.3622	0.4323	0.4687	0.5059	0.5440	0.5830	0.6230	0.6640	0.7491	0.8387
55	0.3825	0.2905	0.3565	0.4256	0.4614	0.4980	0.5355	0.5739	0.6133	0.6536	0.7374	0.8257
60	0.3884	0.2861	0.3511	0.4191	0.4543	0.4904	0.5273	0.5652	0.6039	0.6436	0.7262	0.8130
65	0.3944	0.2818	0.3458	0.4128	0.4475	0.4830	0.5194	0.5566	0.5948	0.6340	0.7152	0.8008
70	0.4003	0.2776	0.3407	0.4067	0.4409	0.4759	0.5117	0.5484	0.5860	0.6246	0.7046	0.7889

^aThe manufacturer's listing specifies the temperature range for operation.

^b W/V [agent weight requirements (kg/m³)] = kilograms required per cubic meter of protected volume to produce indicated concentration at temperature specified.

$$W = \frac{V}{s} \left(\frac{C}{100 - C} \right)$$

^c t [temperature (°C)] = design temperature in the hazard area.

^d s [specific volume (m³/kg)] = specific volume of HFC-23 vapor can be approximated by $s = 0.3164 + 0.0012t$, where t = temperature (°C).

^e C [concentration (%)] = volumetric concentration of HFC-23 in air at the temperature indicated.

brackets. Note that excessively high extinguishment times (>60 seconds), which is generally an indication of inadequate agent concentrations, yield qualitatively high HF concentrations; Halon 1301 will yield bromine and hydrogen bromide in addition to HF.

The quantity of HF formed in the tests for all the halocarbon agents tested is approximately three to eight times higher than that formed for Halon 1301 (which also forms bromine and hydrogen bromide). It is important to note that as pointed out by Peatross and Forssell (1996), in many of these large fire scenarios the levels of combustion products (e.g., CO) and the high temperatures involved make it unlikely that a person could survive large fires such as these, irrespective of the HF exposure. The iodine-containing agent CF₃I was not tested in the USCG or NRL studies, but other data available on CF₃I indicate that its production of HF is comparable to that of Halon 1301. In addition, elemental iodine (I₂) is formed from CF₃I.

There might be differences between the various HFC/HCFC compounds tested, but it is not clear from these data whether such differences exist. In all the data reported, the fire sources — heptane or diesel pans of varying sizes — were baffled to prevent direct interaction with the agent.

While the above results are based on Class B fuels, fires involving some Class A combustibles produce lower HF concentrations. For example, hazards such as those in electronic data processing and telecommunication facilities often result in fire sizes of less than 10 kW at detection (Meacham, 1993). In many cases in the telecommunication industry, detection at fire sizes of 1 kW is desired (Grosshandler, 1998). Skaggs and Moore (1994) have pointed out that for typical computer rooms and office spaces, the analysis of DiNenno et al. (DiNenno, 1993) employing fire growth models and test data indicates that thermal decomposition product concentrations from the halogenated agents would be comparable to that from Halon 1301.

Table A.5.5.1(m) HFC-236fa Total Flooding Quantity (U.S. Units)^a

Temp (<i>t</i>) (°F) ^c	Specific Vapor Volume (<i>s</i>) (ft ³ /lb) ^d	Weight Requirements of Hazard Volume, <i>W/V</i> (lb/ft ³) ^b									
		Design Concentration (% by Volume) ^e									
		5	6	7	8	9	10	11	12	13	14
30	2.2454	0.0234	0.0284	0.0335	0.0387	0.0440	0.0495	0.0550	0.0607	0.0665	0.0725
40	2.2997	0.0229	0.0278	0.0327	0.0378	0.0430	0.0483	0.0537	0.0593	0.0650	0.0708
50	2.3533	0.0224	0.0271	0.0320	0.0370	0.0420	0.0472	0.0525	0.0579	0.0635	0.0692
60	2.4064	0.0219	0.0265	0.0313	0.0361	0.0411	0.0462	0.0514	0.0567	0.0621	0.0676
70	2.4591	0.0214	0.0260	0.0306	0.0354	0.0402	0.0452	0.0503	0.0555	0.0608	0.0662
80	2.5114	0.0210	0.0254	0.0300	0.0346	0.0394	0.0442	0.0492	0.0543	0.0595	0.0648
90	2.5633	0.0205	0.0249	0.0294	0.0339	0.0386	0.0433	0.0482	0.0532	0.0583	0.0635
100	2.6150	0.0201	0.0244	0.0288	0.0333	0.0378	0.0425	0.0473	0.0521	0.0571	0.0623
110	2.6663	0.0197	0.0239	0.0282	0.0326	0.0371	0.0417	0.0464	0.0511	0.0560	0.0611
120	2.7174	0.0194	0.0235	0.0277	0.0320	0.0364	0.0409	0.0455	0.0502	0.0550	0.0599
130	2.7683	0.0190	0.0231	0.0272	0.0314	0.0357	0.0401	0.0446	0.0493	0.0540	0.0588
140	2.8190	0.0187	0.0226	0.0267	0.0308	0.0351	0.0394	0.0438	0.0484	0.0530	0.0577
150	2.8695	0.0183	0.0222	0.0262	0.0303	0.0345	0.0387	0.0431	0.0475	0.0521	0.0567
160	2.9199	0.0180	0.0219	0.0258	0.0298	0.0339	0.0381	0.0423	0.0467	0.0512	0.0558
170	2.9701	0.0177	0.0215	0.0253	0.0293	0.0333	0.0374	0.0416	0.0459	0.0503	0.0548
180	3.0202	0.0174	0.0211	0.0249	0.0288	0.0327	0.0368	0.0409	0.0452	0.0495	0.0539
190	3.0702	0.0171	0.0208	0.0245	0.0283	0.0322	0.0362	0.0403	0.0444	0.0487	0.0530
200	3.1201	0.0169	0.0205	0.0241	0.0279	0.0317	0.0356	0.0396	0.0437	0.0479	0.0522

^aThe manufacturer's listing specifies the temperature range for operation.

^b W/V [agent weight requirements (lb/ft³)] = pounds of agent required per cubic foot of protected volume to produce indicated concentration at temperature specified.

$$W = \frac{V}{s} \left(\frac{C}{100 - C} \right)$$

^c*t* [temperature (°F)] = design temperature in the hazard area.

^d*s* [specific volume (ft³/lb)] = specific volume of HFC-236fa vapor can be approximated by $s = 2.0983 + 0.0051t$, where *t* = temperature (°F).

^e*C* [concentration (%)] = volumetric concentration of HFC-236fa in air at the temperature indicated.

Tests by Hughes Associates, Inc. (1995) evaluated the thermal decomposition products resulting from the extinguishment of Class A fires typical of those encountered in telecommunication and electronic data processing (EDP) facilities by HFC-227ea. The test fuels included shredded paper, PC boards, PVC-coated wire cables, and magnetic tape, representing the most common fuel sources expected to burn in a computer room environment. All fires were extinguished with the minimum design concentration of 7 percent HFC-227ea. Figure A.5.7.1.1(b) (Peatross and Forssell, 1996) shows the HF concentration resulting from these tests. Also shown in Figure A.5.7.1.1(b) is the approximate mammalian median lethal concentration (LC₅₀) (Sax, 1984) and the dangerous toxic load (DTL) for humans based on the analysis of Meldrum (1993). As seen in Figure A.5.7.1.1(b), the HF levels produced in the computer room were below both the estimated mammalian LC₅₀ and DTL curves. Peatross and Forssell (1996), in their analysis of the test results, concluded that "from an examination of the HF exposures, it is evident that this type of fire does not pose a toxic threat." Also shown in Figure A.5.7.1.1(b) are HF levels produced upon extinguishment of Class B fires of various sizes. In the case of these large Class B fires, HF levels in some cases can be seen to exceed the human DTL. It is important to note that, as pointed out by Peatross and Forssell (1996), in many of these large fire scenar-

ios the levels of combustion products (e.g., CO) and the high temperatures involved make it unlikely that a person could survive large fires such as these, irrespective of the HF exposure.

Some agents, such as inert gases, will not form decomposition products and hence do not require discharge time limitations on that basis. However, the increased combustion products and oxygen level reduction associated with longer discharge times should be considered.

Agent mass flow rates should be sufficiently high to cause adequate agent mixing and distribution in the compartment. In general, this parameter is determined by the listing of system hardware.

Overpressurization of the protected compartment also should be considered in determining minimum discharge time.

Other secondary flow effects on personnel and equipment include formation of missiles caused by very high discharge velocities, higher noise levels, lifting ceiling panels, among others. The likelihood of these effects increases if the maximum discharge time is set too low.

Table A.5.5.1(n) HFC-236fa Total Flooding Quantity (SI Units)^a

Temp (<i>t</i>) (°C)	Specific Vapor Volume (<i>s</i>) (m ³ /kg) ^d	Weight Requirements of Hazard Volume, <i>W/V</i> (kg/m ³) ^b									
		Design Concentration (% by volume) ^c									
		5	6	7	8	9	10	11	12	13	14
0	0.1409	0.3736	0.4531	0.5344	0.6173	0.7021	0.7888	0.8774	0.9681	1.0608	1.1557
5	0.1439	0.3658	0.4436	0.5231	0.6043	0.6873	0.7721	0.8589	0.9476	1.0384	1.1313
10	0.1469	0.3583	0.4345	0.5123	0.5919	0.6732	0.7563	0.8413	0.9282	1.0171	1.1081
15	0.1499	0.3511	0.4258	0.5021	0.5801	0.6598	0.7412	0.8245	0.9097	0.9968	1.0860
20	0.1529	0.3443	0.4176	0.4924	0.5689	0.6470	0.7269	0.8086	0.8921	0.9775	1.0650
25	0.1558	0.3378	0.4097	0.4831	0.5581	0.6348	0.7131	0.7932	0.8752	0.9590	1.0448
30	0.1587	0.3316	0.4021	0.4742	0.5478	0.6231	0.7000	0.7787	0.8591	0.9414	1.0256
35	0.1616	0.3256	0.3949	0.4657	0.5380	0.6119	0.6874	0.7646	0.8436	0.9244	1.0071
40	0.1645	0.3199	0.3880	0.4575	0.5285	0.6011	0.6753	0.7512	0.8288	0.9082	0.9894
45	0.1674	0.3144	0.3813	0.4496	0.5194	0.5908	0.6637	0.7383	0.8145	0.8926	0.9724
50	0.1703	0.3091	0.3749	0.4420	0.5107	0.5808	0.6525	0.7258	0.8008	0.8775	0.9560
55	0.1731	0.3040	0.3687	0.4347	0.5022	0.5712	0.6417	0.7138	0.7876	0.8630	0.9402
60	0.1760	0.2991	0.3627	0.4277	0.4941	0.5620	0.6313	0.7023	0.7748	0.8491	0.9250
65	0.1788	0.2943	0.3569	0.4209	0.4863	0.5531	0.6214	0.6912	0.7626	0.8356	0.9104
70	0.1817	0.2897	0.3514	0.4143	0.4787	0.5444	0.6116	0.6804	0.7507	0.8226	0.8961
75	0.1845	0.2853	0.3460	0.4080	0.4714	0.5361	0.6023	0.6700	0.7392	0.8100	0.8824
80	0.1873	0.2810	0.3408	0.4019	0.4643	0.5280	0.5932	0.6599	0.7280	0.7978	0.8691
85	0.1901	0.2768	0.3358	0.3959	0.4574	0.5202	0.5845	0.6501	0.7173	0.7860	0.8563
90	0.1929	0.2728	0.3309	0.3902	0.4508	0.5127	0.5760	0.6407	0.7069	0.7746	0.8439
95	0.1957	0.2689	0.3261	0.3846	0.4443	0.5053	0.5677	0.6315	0.6968	0.7635	0.8318

^aThe manufacturer's listing specifies the temperature range for operation.

^b*W/V* [agent weight requirements (kg/m³)] = kilograms of agent required per cubic meter of protected volume to produce indicated concentration at temperature specified.

$$W = \frac{V}{s} \left(\frac{C}{100 - C} \right)$$

^c*t* [temperature (°C)] = design temperature in the hazard area.

^d*s* [specific volume (m³/kg)] = specific volume of HFC-236fa vapor can be approximated by $s = 0.1413 + 0.0006t$, where t = temperature (°C).

^e*C* [concentration (%)] = volumetric concentration of HFC-236fa in air at the temperature indicated.

The maximum 10-second discharge time given in this standard reflects a reasonable value based on experience with Halon 1301 systems. The maximum and minimum discharge times should reflect consideration of the factors previously described.

For inert gases, the measured discharge time is considered to be the time when the measuring device starts to record reduction of oxygen until the design oxygen reduction level is achieved.

Systems designed for explosion prevention present particular design challenges. These systems typically discharge the agent, before ignition occurs, on detection of some specified fraction of the lower flammable limit of the flammable vapors present.

A.5.7.1.1.1 The minimum design concentration for flame extinguishment is defined in 5.4.2.2 and includes safety factors for both Class A (surface fires) and Class B hazards. However, many applications involve the use of higher than normal design concentrations for flame extinguishment in order to accomplish the following:

- (1) Provide an initial concentration that will pass minimum holding time requirements

- (2) Allow hot surfaces to cool and thus prevent re-ignition
- (3) Provide protection for electrical equipment that remains energized
- (4) Provide inerting concentrations to protect against the worst-case possibility of explosion of gas vapors, without a fire developing

In the examples cited in A.5.7.1.1.1(1) through A.5.7.1.1.1(4), it is the intent of 5.7.1.1 to allow discharge times greater than 10 seconds for halocarbon agents and greater than 60 seconds for inert gas agents (for that portion of the agent mass that exceeds the quantity required to achieve the minimum design concentration for flame extinguishment). The additional quantity of clean agent is to be introduced into the hazard at the same nominal flow rate required to achieve the flame extinguishing design concentration, using the same piping and nozzle(s) distribution system; as an alternative, separate piping networks with different flow rates can be used.

A.5.7.1.1.2 See A.5.7.1.1.1.

Table A.5.5.1(o) FIC-131I Total Flooding Quantity (U.S. Units)^a

Temp (<i>t</i>) (°F) ^c	Specific Vapor Volume (<i>s</i>) (ft ³ /lb) ^d	Weight Requirements of Hazard Volume, <i>W/V</i> (lb/ft ³) ^b							
		Design Concentration (% by Volume) ^e							
		3	4	5	6	7	8	9	10
0	1.6826	0.0184	0.0248	0.0313	0.0379	0.0447	0.0517	0.0588	0.0660
10	1.7264	0.0179	0.0241	0.0305	0.0370	0.0436	0.0504	0.0573	0.0644
20	1.7703	0.0175	0.0235	0.0297	0.0361	0.0425	0.0491	0.0559	0.0628
30	1.8141	0.0170	0.0230	0.0290	0.0352	0.0415	0.0479	0.0545	0.0612
40	1.8580	0.0166	0.0224	0.0283	0.0344	0.0405	0.0468	0.0532	0.0598
50	1.9019	0.0163	0.0219	0.0277	0.0336	0.0396	0.0457	0.0520	0.0584
60	1.9457	0.0159	0.0214	0.0270	0.0328	0.0387	0.0447	0.0508	0.0571
70	1.9896	0.0155	0.0209	0.0265	0.0321	0.0378	0.0437	0.0497	0.0558
80	2.0335	0.0152	0.0205	0.0259	0.0314	0.0370	0.0428	0.0486	0.0546
90	2.0773	0.0149	0.0201	0.0253	0.0307	0.0362	0.0419	0.0476	0.0535
100	2.1212	0.0146	0.0196	0.0248	0.0301	0.0355	0.0410	0.0466	0.0524
110	2.1650	0.0143	0.0192	0.0243	0.0295	0.0348	0.0402	0.0457	0.0513
120	2.2089	0.0140	0.0189	0.0238	0.0289	0.0341	0.0394	0.0448	0.0503
130	2.2528	0.0137	0.0185	0.0234	0.0283	0.0334	0.0386	0.0439	0.0493
140	2.2966	0.0135	0.0181	0.0229	0.0278	0.0328	0.0379	0.0431	0.0484
150	2.3405	0.0132	0.0178	0.0225	0.0273	0.0322	0.0372	0.0423	0.0475
160	2.3843	0.0130	0.0175	0.0221	0.0268	0.0316	0.0365	0.0415	0.0466
170	2.4282	0.0127	0.0172	0.0217	0.0263	0.0310	0.0358	0.0407	0.0458
180	2.4721	0.0125	0.0169	0.0213	0.0258	0.0304	0.0352	0.0400	0.0449
190	2.5159	0.0123	0.0166	0.0209	0.0254	0.0299	0.0346	0.0393	0.0442
200	2.5598	0.0121	0.0163	0.0206	0.0249	0.0294	0.0340	0.0386	0.0434

^aThe manufacturer's listing specifies the temperature range for operation.

^b*W/V* [agent weight requirements (lb/ft³)] = pounds of agent required per cubic foot of protected volume to produce indicated concentration at temperature specified.

$$W = \frac{V}{s} \left(\frac{C}{100 - C} \right)$$

^c*t* [temperature (°F)] = design temperature in the hazard area.

^d*s* [specific volume (ft³/lb)] = specific volume of FIC-131I vapor can be approximated by $s = 1.683 + 0.0044t$, where *t* = temperature (°F).

^e*C* [concentration (%)] = volumetric concentration of FIC-131I in air at the temperature indicated.

A.5.7.1.1.3 For third-party listing or approval of pre-engineered systems or flow calculation software for engineered systems (see 5.2.1), direct measurement of the point in time at which 95 percent of the agent mass is discharged from the nozzle is not necessary to satisfy compliance with the intent of 5.7.1.1.3. For some agents, the point in time at which 95 percent of the total agent mass coming from a given nozzle is extremely difficult to measure. Rather, for a given agent, a surrogate measurement based on engineering principles can be used. For instance, for some halocarbon agents, the point in which the agent discharge changes from predominately liquid to gas represents approximately 95 percent of the agent mass out of the nozzle and has been previously used in the listing/approval testing for discharge time. For low boiling point agents, the point at which the agent discharge changes from predominately liquid to gas may not be appropriate because this can occur before the point of 95 percent mass discharged. For such agents, a method has been developed that utilizes an equation of state and measured cylinder conditions from the point at which the agent discharge changes from predominately liquid to gas to calculate an agent mass balance in the network of cylinders and pipes. The experimental discharge

time is taken as the point at which the summed calculated mass discharged from all nozzles equals 95 percent of the agent required to achieve minimum design concentration.

A.5.7.2 Special attention should be paid to safety and health issues when extended discharge systems are being considered.

The effect of decomposition products on electronic equipment is a potential area of concern. Sufficient data at present are not available to predict the effects of a given HF exposure scenario on all electronic equipment. Several evaluations of the effect of HF on electronics equipment have been performed relative to the decomposition of Halon 1301, where decomposition products include HF and HBr. One of the more notable was a National Aeronautics and Space Administration (NASA) study in which the space shuttle *Orbiter's* electronics were exposed to 700, 7000, and 70,000 ppm HF and HBr (Pedley, 1995). In those tests, exposures up to 700 ppm HF and HBr caused no failures. At 7000 ppm, severe corrosion was noted, and there were some operating failures.

Table A.5.5.1(p) FIC-131I Total Flooding Quantity (SI Units)^a

Temp (<i>t</i>) (°C) ^c	Specific Vapor Volume (<i>s</i>) (m ³ /kg) ^d	Weight Requirements of Hazard Volume, <i>W/V</i> (kg/m ³) ^b							
		Design Concentration (% by Volume) ^e							
		3	4	5	6	7	8	9	10
-40	0.0938	0.3297	0.4442	0.5611	0.6805	0.8024	0.9270	1.0544	1.1846
-30	0.0988	0.3130	0.4217	0.5327	0.6461	0.7618	0.8801	1.0010	1.1246
-20	0.1038	0.2980	0.4014	0.5070	0.6149	0.7251	0.8377	0.9528	1.0704
-10	0.1088	0.2843	0.3830	0.4837	0.5867	0.6918	0.7992	0.9090	1.0212
0	0.1138	0.2718	0.3661	0.4625	0.5609	0.6614	0.7641	0.8691	0.9764
10	0.1188	0.2603	0.3507	0.4430	0.5373	0.6336	0.7320	0.8325	0.9353
20	0.1238	0.2498	0.3366	0.4251	0.5156	0.6080	0.7024	0.7989	0.8975
30	0.1288	0.2401	0.3235	0.4086	0.4956	0.5844	0.6751	0.7679	0.8627
40	0.1338	0.2311	0.3114	0.3934	0.4771	0.5625	0.6499	0.7392	0.8304
50	0.1388	0.2228	0.3002	0.3792	0.4599	0.5423	0.6265	0.7125	0.8005
60	0.1438	0.2151	0.2898	0.3660	0.4439	0.5234	0.6047	0.6878	0.7727
70	0.1488	0.2078	0.2800	0.3537	0.4290	0.5058	0.5844	0.6647	0.7467
80	0.1538	0.2011	0.2709	0.3422	0.4150	0.4894	0.5654	0.6431	0.7224
90	0.1588	0.1948	0.2624	0.3314	0.4020	0.4740	0.5476	0.6228	0.6997
100	0.1638	0.1888	0.2544	0.3213	0.3897	0.4595	0.5309	0.6038	0.6783

^aThe manufacturer's listing specifies the temperature range for operation.

^b*W/V* [agent weight requirements (kg/m³)] = kilograms required per cubic meter of protected volume to produce indicated concentration at temperature specified.

$$W = \frac{V}{s} \left(\frac{C}{100 - C} \right)$$

^c*t* [temperature (°C)] = design temperature in the hazard area.

^d*s* [specific volume (m³/kg)] = specific volume of FIC-131I vapor can be approximated by $s = 0.1138 + 0.0005t$, where t = temperature (°C).

^e*C* [concentration (%)] = volumetric concentration of FIC-131I in air at the temperature indicated.

Dumayas (1992) exposed IBM-PC compatible multifunction cards to environments produced by a range of fire sizes as part of an evaluation program on halon alternatives. He found no loss of function of the boards following a 15-minute exposure to post-fire extinguishment atmosphere up to 5000 ppm HF, with unconditioned samples stored at ambient humidity and temperature conditions for up to 30 days. Forssell et al. (1994) exposed multifunction boards for 30 minutes in the post-fire extinguishment environment; no failures were reported up to 90 days post-test. HF concentrations up to 550 ppm were evaluated.

While no generic rule or statement can be made at this time, it appears that short-term damage (<90 days) resulting in electronic equipment malfunction is not likely for exposures up to 500 ppm HF for up to 30 minutes. This damage, however, is dependent on the characteristics of the equipment exposed, post-exposure treatment, exposure to other combustion products, and relative humidity. Important equipment characteristics include its location in the space, existence of equipment enclosures, and the sensitivity of the equipment to damage.

Extended discharge applications inherently have a performance objective of maintaining the agent concentration at or above the design concentration within the enclosure. This objective is valid if there is mixing of agent continually in the enclosure during the hold period, and the enclosure thereby experiences a decaying concentration over time as opposed to a descending interface. The application of agent should be

done with sufficient turbulence to accomplish mixing of the additional agent throughout the enclosure. To accomplish this, the extended discharge probably will need to be performed through a separate network of piping and nozzles. These systems are outside the scope of current design requirements and testing procedures for total flooding systems. Systems should be designed and fully discharge tested on a case-by-case basis until the body of knowledge is sufficient enough to be addressed specifically in this standard.

A.6.1.3 Local concentrations of agent in the vicinity of the discharge often will exceed the maximum permitted exposure limits described in Section 1.5.

Consideration for exposure to agent discharge from local application systems varies greatly and may be more complicated than that for total flooding systems, depending on the following:

- (1) Quantity of agent released
- (2) Time needed to extinguish the fire
- (3) Size of the room or enclosure in which the fire occurs
- (4) Size of the fire
- (5) Proximity of the person to the point of discharge of the agent
- (6) Rate at which fresh air infiltrates the space
- (7) Air exchange rate near the fire

Table A.5.5.1(q) HFC Blend B Total Flooding Quantity Table (U.S. Units)^a

Temp (<i>t</i>) (°F) ^c	Specific Vapor Volume (<i>s</i>) (ft ³ /lb) ^d	Weight Requirement of Hazard Volume <i>W/V</i> (lb/ft ³) ^b								
		Concentration (% by volume) ^e								
		8	9	10	11	12	13	14	15	16
-40	2.9642	0.0293	0.0334	0.0375	0.0417	0.0460	0.0504	0.0549	0.0595	0.0643
-30	3.0332	0.0287	0.0326	0.0366	0.0407	0.0450	0.0493	0.0537	0.0582	0.0628
-20	3.1022	0.0280	0.0319	0.0358	0.0398	0.0440	0.0482	0.0525	0.0569	0.0614
-10	3.1712	0.0274	0.0312	0.0350	0.0390	0.0430	0.0471	0.0513	0.0556	0.0601
0	3.2402	0.0268	0.0305	0.0343	0.0381	0.0421	0.0461	0.0502	0.0545	0.0588
10	3.3092	0.0263	0.0299	0.0336	0.0373	0.0412	0.0452	0.0492	0.0533	0.0576
20	3.3782	0.0257	0.0293	0.0329	0.0366	0.0404	0.0442	0.0482	0.0522	0.0564
30	3.4472	0.0252	0.0287	0.0322	0.0359	0.0396	0.0433	0.0472	0.0512	0.0553
40	3.5162	0.0247	0.0281	0.0316	0.0352	0.0388	0.0425	0.0463	0.0502	0.0542
50	3.5852	0.0243	0.0276	0.0310	0.0345	0.0380	0.0417	0.0454	0.0492	0.0531
60	3.6542	0.0238	0.0271	0.0304	0.0338	0.0373	0.0409	0.0445	0.0483	0.0521
70	3.7232	0.0234	0.0266	0.0298	0.0332	0.0366	0.0401	0.0437	0.0474	0.0512
80	3.7922	0.0229	0.0261	0.0293	0.0326	0.0360	0.0394	0.0429	0.0465	0.0502
90	3.8612	0.0225	0.0256	0.0288	0.0320	0.0353	0.0387	0.0422	0.0457	0.0493
100	3.9302	0.0221	0.0252	0.0283	0.0314	0.0347	0.0380	0.0414	0.0449	0.0485
110	3.9992	0.0217	0.0247	0.0278	0.0309	0.0341	0.0374	0.0407	0.0441	0.0476
120	4.0682	0.0214	0.0243	0.0273	0.0304	0.0335	0.0367	0.0400	0.0434	0.0468
130	4.1372	0.0210	0.0239	0.0269	0.0299	0.0330	0.0361	0.0393	0.0427	0.0460
140	4.2062	0.0207	0.0235	0.0264	0.0294	0.0324	0.0355	0.0387	0.0420	0.0453
150	4.2752	0.0203	0.0231	0.0260	0.0289	0.0319	0.0350	0.0381	0.0413	0.0446
160	4.3442	0.0200	0.0228	0.0256	0.0285	0.0314	0.0344	0.0375	0.0406	0.0438
170	4.4132	0.0197	0.0224	0.0252	0.0280	0.0309	0.0339	0.0369	0.0400	0.0432
180	4.4822	0.0194	0.0221	0.0248	0.0276	0.0304	0.0333	0.0363	0.0394	0.0425
190	4.5512	0.0191	0.0217	0.0244	0.0272	0.0300	0.0328	0.0358	0.0388	0.0419
200	4.6202	0.0188	0.0214	0.0240	0.0268	0.0295	0.0323	0.0352	0.0382	0.0412

^aThe manufacturer's listing specifies the temperature range for operation.

^b *W/V* [agent weight requirement (lb/ft³)] = pounds of agent required per cubic foot of protected volume to produce indicated concentration at temperature specified.

$$W = \frac{V}{s} \left(\frac{C}{100 - C} \right)$$

^c *t* [temperature (°F)] = the design temperature in the hazard area.

^d *s* [specific volume (ft³/lb)] = specific volume of HFC Blend B vapor can be approximated by $s = 3.2402 + 0.0069t$, where t = temperature (°F).

^e *C* [concentration (%)] = volumetric concentration of HFC Blend B in air at the temperature indicated.

One approach to assess consumer exposure is to employ a "box model," which has been widely used for many years to estimate probable exposures of workers to hazardous airborne materials, and has been described in detail by the National Institute for Occupational Safety and Health (NIOSH). The box model takes into consideration assumptions on the volume of the space in which the extinguishant is used, the rate at which fresh air infiltrates the space, the quantity and rate of agent release, the area of the fire, the location of the worker, and the air exchange rate in the vicinity of the fire. Values obtained through the box model, compared to cardiotoxic NOAEL/LOAEL values, provide a screen for assessing risk.

It should be noted that because the model can overstate the actual exposure to an agent, it might be necessary to conduct personal monitoring tests in actual-use scenarios in order to complete the assessment.

A.6.4.1.1 The maximum permitted time for fire extinguishment is based upon extinguishing agent being present at the discharge nozzle. For halocarbon agents, this typically is identified with either a pressure at the nozzle of 25 psi (1.7 bar) or rate of pressure increase of 11 psi/sec (0.8 bar/sec). The times for test fires to be extinguished are from this reference point.

A.6.4.1.2 The maximum permitted time for fire extinguishment is based upon extinguishing agent being present at the discharge nozzle. Typically for inert gas agents, this is identified with either a pressure at the nozzle of 200 psi (13.8 bar) or rate of pressure increase of 600 psi/sec (41.4 bar/sec). The times for test fires to be extinguished are from this reference point.

Table A.5.5.1(r) HFC Blend B Total Flooding Quantity Table (SI Units)^a

Temp (<i>t</i>) (°C) ^c	Specific Vapor Volume (<i>s</i>) (m ³ /kg) ^d	Weight Requirement of Hazard Volume <i>W/V</i> (kg/m ³) ^b								
		Concentration (% by volume) ^e								
		8	9	10	11	12	13	14	15	16
-40	0.1812	0.4799	0.5458	0.6132	0.6821	0.7526	0.8246	0.8984	0.9739	1.0512
-30	0.1902	0.4572	0.5200	0.5842	0.6498	0.7169	0.7856	0.8559	0.9278	1.0015
-20	0.1992	0.4365	0.4965	0.5578	0.6205	0.6846	0.7501	0.8172	0.8859	0.9562
-10	0.2082	0.4177	0.4750	0.5337	0.5936	0.6550	0.7177	0.7819	0.8476	0.9149
0	0.2172	0.4004	0.4553	0.5116	0.5690	0.6278	0.6880	0.7495	0.8125	0.8770
10	0.2262	0.3844	0.4372	0.4912	0.5464	0.6028	0.6606	0.7197	0.7802	0.8421
20	0.2352	0.3697	0.4205	0.4724	0.5255	0.5798	0.6353	0.6921	0.7503	0.8098
30	0.2442	0.3561	0.4050	0.4550	0.5061	0.5584	0.6119	0.6666	0.7226	0.7800
40	0.2532	0.3434	0.3906	0.4388	0.4881	0.5386	0.5901	0.6429	0.6970	0.7523
50	0.2622	0.3316	0.3772	0.4238	0.4714	0.5201	0.5699	0.6209	0.6730	0.7265
60	0.2712	0.3206	0.3647	0.4097	0.4557	0.5028	0.5510	0.6003	0.6507	0.7023
70	0.2802	0.3103	0.3530	0.3965	0.4411	0.4867	0.5333	0.5810	0.6298	0.6798
80	0.2892	0.3007	0.3420	0.3842	0.4274	0.4715	0.5167	0.5629	0.6102	0.6586
90	0.2982	0.2916	0.3317	0.3726	0.4145	0.4573	0.5011	0.5459	0.5918	0.6388
100	0.3072	0.2831	0.3219	0.3617	0.4023	0.4439	0.4864	0.5299	0.5744	0.6200
110	0.3162	0.2750	0.3128	0.3514	0.3909	0.4313	0.4726	0.5148	0.5581	0.6024
120	0.3252	0.2674	0.3041	0.3417	0.3801	0.4193	0.4595	0.5006	0.5427	0.5857
130	0.3342	0.2602	0.2959	0.3325	0.3698	0.4080	0.4471	0.4871	0.5280	0.5699
140	0.3432	0.2534	0.2882	0.3238	0.3601	0.3973	0.4354	0.4743	0.5142	0.5550
150	0.3522	0.2469	0.2808	0.3155	0.3509	0.3872	0.4243	0.4622	0.5011	0.5408
160	0.3612	0.2407	0.2738	0.3076	0.3422	0.3775	0.4137	0.4507	0.4886	0.5273
170	0.3702	0.2349	0.2672	0.3001	0.3339	0.3684	0.4036	0.4397	0.4767	0.5145
180	0.3792	0.2293	0.2608	0.2930	0.3259	0.3596	0.3941	0.4293	0.4654	0.5023
190	0.3882	0.2240	0.2548	0.2862	0.3184	0.3513	0.3849	0.4193	0.4546	0.4907
200	0.3972	0.2189	0.2490	0.2797	0.3112	0.3433	0.3762	0.4098	0.4443	0.4795

^aThe manufacturer's listing specifies the temperature range for operation.

^b*W/V* [agent weight requirement (kg/m³)] = kilograms of agent required per cubic meter of protected volume to produce indicated concentration at temperature specified.

$$W = \frac{V}{s} \left(\frac{C}{100 - C} \right)$$

^c*t* [temperature (°C)] = design temperature in the hazard area.

^d*s* [specific volume (m³/kg)] = specific volume of HFC Blend B vapor can be approximated by $s = 0.2172 + 0.0009t$, where *t* = temperature (°C).

^e*C* [concentration (%)] = volumetric concentration of HFC Blend B in air at the temperature indicated.

A.6.4.1.3 The nozzle listing evaluation should consider application on fuels, including solids and flammable liquids; orientation and angle of discharge; intended area of coverage and the related distance from fire; and extinguishment time and the related discharge rate. Testing of flammable liquids of appreciable depth (over ¼ in.) will consider evaluation of splash and extinguishment. The evaluation for splash will be at maximum rates of flow from minimum pressure loss in the piping limitations and maximum operating temperature of the system. The evaluation for extinguishment will be at minimum rates of flow from maximum pressure loss in the piping limitations and minimum operating temperature of the system.

A.6.4.3.3 The maximum temperature of a burning liquid fuel is limited by its boiling point where evaporative cooling matches the heat input. In most liquids, the auto-ignition temperature is far above the boiling temperature, so that re-ignition after extinguishment can be caused only by an external ignition source. However, a few liquids have auto-ignition

temperatures that are much lower than their boiling temperatures. Common cooking oils and melted paraffin wax have this property. To prevent re-ignition in these materials, it is necessary to maintain an extinguishing atmosphere until the fuel has cooled below its auto-ignition temperature.

A.6.5.1 Areas that require multiple nozzles should be considered as part of the listing.

A.6.5.2 Nozzles should be located so that they do not interfere with normal operations and maintenance in the hazard area.

A.6.6 The system should be designed to provide an effective discharge of clean agent promptly before excessive amounts of heat can be absorbed by materials within the hazard. Rapid detection should be considered. The clean agent supply should be located as near to the hazard as practicable and yet not exposed to the fire, and the pipeline should be as direct as practicable with a minimum number of turns in order to get clean agent to the fire promptly.

▲ Table A.5.5.2(a) IG-01 Total Flooding Quantity (U.S. Units)^a

Temp (t) (°F) ^c	Specific Vapor Volume (s) (ft ³ /lb) ^d	Volume Requirements of Agent per Unit Volume of Hazard ($V_{\text{agent}}/V_{\text{enclosure}}$) ^b							
		Design Concentration (% by Volume) ^e							
		34	37	40	42	47	49	58	62
-40	7.67176	0.524	0.583	0.645	0.688	0.801	0.850	1.095	1.221
-30	7.85457	0.512	0.570	0.630	0.672	0.783	0.830	1.069	1.193
-20	8.03738	0.501	0.557	0.615	0.656	0.765	0.811	1.045	1.166
-10	8.22019	0.489	0.544	0.602	0.642	0.748	0.793	1.022	1.140
0	8.40299	0.479	0.532	0.589	0.628	0.732	0.776	1.000	1.115
10	8.58580	0.469	0.521	0.576	0.614	0.716	0.759	0.978	1.091
20	8.76861	0.459	0.510	0.564	0.602	0.701	0.744	0.958	1.088
30	8.95142	0.449	0.500	0.553	0.589	0.687	0.728	0.938	1.047
40	9.13422	0.440	0.490	0.541	0.577	0.673	0.714	0.920	1.026
50	9.31703	0.432	0.480	0.531	0.566	0.660	0.700	0.902	1.006
60	9.49984	0.424	0.471	0.521	0.555	0.647	0.686	0.884	0.986
70	9.68265	0.416	0.462	0.511	0.545	0.635	0.673	0.868	0.958
80	9.86545	0.408	0.453	0.501	0.535	0.623	0.661	0.851	0.950
90	10.04826	0.400	0.445	0.492	0.525	0.612	0.649	0.836	0.932
100	10.23107	0.393	0.437	0.483	0.516	0.601	0.637	0.821	0.916
110	10.41388	0.386	0.430	0.475	0.506	0.590	0.626	0.807	0.900
120	10.59668	0.380	0.422	0.467	0.498	0.580	0.615	0.793	0.884
130	10.77949	0.373	0.415	0.459	0.489	0.570	0.605	0.779	0.869
140	10.96230	0.367	0.408	0.451	0.481	0.561	0.595	0.766	0.855
150	11.14511	0.361	0.401	0.444	0.473	0.552	0.585	0.754	0.841
160	11.32791	0.355	0.395	0.437	0.466	0.543	0.576	0.742	0.827
170	11.51072	0.350	0.389	0.430	0.458	0.534	0.566	0.730	0.814
180	11.69353	0.344	0.383	0.423	0.451	0.526	0.558	0.718	0.801
190	11.87634	0.339	0.377	0.416	0.444	0.518	0.549	0.707	0.789
200	12.05914	0.334	0.371	0.410	0.437	0.510	0.541	0.697	0.777

^aThe manufacturer's listing specifies the temperature range for operation.

^b X [agent volume requirements (ft³/ft³)] = volume of agent required per cubic foot of protected volume to produce indicated concentration at temperature specified.

▲

$$X = 2.303 \times \left(\frac{s_0}{s} \right) \times \log_{10} \left(\frac{100}{100 - C} \right) = \left(\frac{s_0}{s} \right) \times \ln \left(\frac{100}{100 - C} \right)$$

where:

s_0 [specific volume (ft³/lb)] = specific volume of inert gas agent at 70°F and 14.7 psi absolute

t [temperature (°F)] = design temperature in the hazard area.

s [specific volume (ft³/lb)] = specific volume of IG-01 vapor can be approximated by $s = 8.514 + 0.0185t$, where t = temperature (°F).

C [concentration (%)] = volumetric concentration of IG-01 in air at the temperature indicated.

▲ **A.7.1** Safety should be a prime concern during installation, service, maintenance, testing, handling, and recharging of clean agent systems and agent containers. One of the major causes of personnel injury and property damage is attributed to the improper handling of agent containers by personnel. In the interest of safety and to minimize the potential for personnel injury and property damage, the following guidelines should be adhered to:

- (1) If any work is to be performed on the fire extinguishing system, qualified fire service personnel, trained and experienced in the type of equipment installed, should be engaged to do the work.
- (2) Personnel involved with fire extinguishing system containers must be thoroughly trained in the safe handling of the containers as well as in the proper procedures for installation, removal, handling, shipping, and filling; and connection and removal of other critical devi-

ces, such as discharge hoses, control heads, discharge heads, initiators, and anti-recoil devices.

- (3) The procedures and cautions outlined on the container nameplates and in the operation and maintenance manuals, owner's manuals, service manuals, and service bulletins that are provided by the equipment manufacturer for the specified equipment installed should be followed.
- (4) Most fire extinguishing system containers are furnished with valve outlet anti-recoil devices and in some cases container valve protection caps. Do not disconnect containers from the system piping or move or ship the containers if the anti-recoil devices or protection caps are missing. Obtain these parts from the distributor of the manufacturer's equipment or the equipment manufacturer. These devices are provided for safety reasons and should be installed at all times, except when the containers are connected into the system piping or being filled.

Table A.5.5.2(b) IG-01 Total Flooding Quantity (SI Units)^a

Temp (<i>t</i>) (°C) ^c	Specific Vapor Volume (<i>s</i>) (m ³ /kg) ^d	Volume Requirements of Agent per Unit Volume of Hazard ($V_{\text{agent}}/V_{\text{enclosure}}$) ^b							
		Design Concentration (% by Volume) ^e							
		34	37	40	42	47	49	58	62
-20	0.5201	0.4812	0.5350	0.5915	0.6308	0.7352	0.7797	1.0046	1.1205
-10	0.5406	0.4629	0.5147	0.5691	0.6068	0.7073	0.7501	0.9664	1.0779
0	0.5612	0.4459	0.4950	0.5482	0.5846	0.6814	0.7226	0.9310	1.0384
10	0.5817	0.4302	0.4784	0.5289	0.5640	0.6573	0.6971	0.8981	1.0018
15	0.5920	0.4227	0.4701	0.5197	0.5542	0.6459	0.6850	0.8828	0.9844
20	0.6023	0.4155	0.4620	0.5108	0.5447	0.6349	0.6733	0.8675	0.9676
30	0.6228	0.4018	0.4468	0.4940	0.5268	0.6139	0.6511	0.8389	0.9357
35	0.6331	0.3953	0.4395	0.4860	0.5182	0.6040	0.6406	0.8253	0.9205
40	0.6434	0.3890	0.4325	0.4762	0.5099	0.5943	0.6303	0.8121	0.9058
50	0.6639	0.3769	0.4191	0.4634	0.4942	0.5759	0.6108	0.7870	0.8778
60	0.6845	0.3656	0.4066	0.4495	0.4793	0.5587	0.5925	0.7633	0.8514
70	0.7050	0.3550	0.3947	0.4304	0.4654	0.5424	0.5752	0.7411	0.8200
80	0.7256	0.3449	0.3835	0.4240	0.4522	0.5270	0.5589	0.7201	0.8032
90	0.7461	0.3354	0.3730	0.4124	0.4397	0.5125	0.5436	0.7003	0.7811
100	0.7666	0.3264	0.3630	0.4013	0.4270	0.4988	0.5290	0.6815	0.7601
110	0.7872	0.3179	0.3535	0.3908	0.4168	0.4857	0.5152	0.6637	0.7403
120	0.8077	0.3098	0.3445	0.3809	0.4062	0.4734	0.5021	0.6468	0.7215

^aThe manufacturer's listing specifies the temperature range for operation.

^b X [agent volume requirements (m³/m³)] = volume of agent required per cubic meter of protected volume to produce indicated concentration at temperature specified.

Δ

$$X = 2.303 \times \left(\frac{s_0}{s} \right) \times \log_{10} \left(\frac{100}{100 - C} \right) = \left(\frac{s_0}{s} \right) \times \ln \left(\frac{100}{100 - C} \right)$$

where:

s_0 [specific volume (m³/kg)] = specific volume of inert gas agent at 21°C and 1.013 bar absolute

t [temperature (°C)] = design temperature in the hazard area.

s [specific volume (m³/kg)] = specific volume of IG-01 vapor can be approximated by $s = 0.5685 + 0.00208t$, where t = temperature (°C).

C [concentration (%)] = volumetric concentration of IG-01 in air at the temperature indicated.

- (5) All control heads, pressure-operated heads, initiators, discharge heads, or other type of actuation devices should be removed before disconnecting the containers from the system piping, and anti-recoil devices and/or protection caps should be immediately installed before the containers are moved or shipped. Most fire extinguishing system equipment varies from manufacturer to manufacturer; therefore, it is important to follow the instructions and procedures provided in the equipment manufacturer's manuals. These actions should be undertaken only by qualified fire extinguishing system service personnel.
- (6) Safety is of prime concern. Never assume that a container is empty. Treat all containers as if they are fully charged. Most fire extinguishing system containers are equipped with high flow rate valves that are capable of producing high discharge thrusts out of the valve outlet if not handled properly. Remember, pressurized containers are extremely hazardous. Failure to follow the equipment manufacturer's instructions and the guidelines contained herein can result in serious bodily injury, death, or property damage.

N A.7.2 Manufacturers of fire extinguishing system equipment should make available the manufacturer's design, installation, and maintenance manual and product safety bulletins to the authority having jurisdiction upon request.

N A.7.2.3.4 A discharge test is generally not required.

N A.7.3.1 A sample test report is provided in Figure A.7.3.1. An alternative form that ensures that all the applicable design, operational, and safety requirements of this standard are documented to the satisfaction of the authority having jurisdiction can be used.

N A.7.4.15 The purpose is to conduct a flow test of short duration (also known as a "puff test") through the piping network to determine that the flow is continuous and to check that valves are oriented in accordance with the system documentation.

The flow test should be performed using gaseous nitrogen or an inert gas at a pressure not to exceed the normal operating pressure of the clean agent system.

The nitrogen or an inert gas pressure should be introduced into the piping network at the clean agent container connection.

Visual indicators should be used to verify that nitrogen or an inert gas has discharged out of each and every nozzle in the system.

△ Table A.5.5.2(c) IG-100 Total Flooding Quantity (U.S. Units)^a

Temp (<i>t</i>) (°F) ^c	Specific Vapor Volume (<i>s</i>) (ft ³ /lb) ^d	Volume Requirements of Agent per Unit Volume of Hazard ($V_{\text{agent}}/V_{\text{enclosure}}$) ^b							
		Design Concentration (% by Volume) ^e							
		34	37	40	42	47	49	58	62
-40	10.934	0.522	0.581	0.642	0.685	0.798	0.847	1.091	1.216
-30	11.195	0.510	0.567	0.627	0.669	0.780	0.827	1.065	1.188
-20	11.455	0.499	0.554	0.613	0.654	0.762	0.808	1.041	1.161
-10	11.716	0.488	0.542	0.599	0.639	0.745	0.790	1.018	1.135
0	11.976	0.477	0.530	0.586	0.625	0.729	0.773	0.996	1.111
10	12.237	0.467	0.519	0.574	0.612	0.713	0.756	0.975	1.087
20	12.497	0.457	0.508	0.562	0.599	0.698	0.741	0.954	1.064
30	12.758	0.448	0.498	0.550	0.587	0.684	0.726	0.935	1.043
40	13.018	0.439	0.488	0.539	0.575	0.670	0.711	0.916	1.022
50	13.279	0.430	0.478	0.529	0.564	0.657	0.697	0.898	1.002
60	13.540	0.422	0.469	0.519	0.553	0.645	0.684	0.881	0.982
70	13.800	0.414	0.460	0.509	0.543	0.632	0.671	0.864	0.964
80	14.061	0.406	0.452	0.499	0.533	0.621	0.658	0.848	0.946
90	14.321	0.399	0.444	0.490	0.523	0.609	0.646	0.833	0.929
100	14.582	0.392	0.436	0.482	0.514	0.599	0.635	0.818	0.912
110	14.842	0.385	0.428	0.473	0.505	0.588	0.624	0.803	0.896
120	15.103	0.378	0.421	0.465	0.496	0.578	0.613	0.790	0.881
130	15.363	0.372	0.413	0.457	0.487	0.568	0.602	0.776	0.866
140	15.624	0.366	0.407	0.449	0.479	0.559	0.592	0.763	0.851
150	15.885	0.360	0.400	0.442	0.471	0.549	0.583	0.751	0.837
160	16.145	0.354	0.393	0.435	0.464	0.541	0.573	0.739	0.824
170	16.406	0.348	0.387	0.428	0.456	0.532	0.564	0.727	0.811
180	16.666	0.343	0.381	0.421	0.449	0.524	0.555	0.716	0.798
190	16.927	0.337	0.375	0.415	0.442	0.516	0.547	0.705	0.786
200	17.187	0.332	0.370	0.409	0.436	0.508	0.539	0.694	0.774

^aThe manufacturer's listing specifies the temperature range for operation.

^b X [agent volume requirements (ft³/ft³)] = volume of agent required per cubic foot of protected volume to produce indicated concentration at temperature specified.

△

$$X = 2.303 \times \left(\frac{s_0}{s} \right) \times \log_{10} \left(\frac{100}{100 - C} \right) = \left(\frac{s_0}{s} \right) \times \ln \left(\frac{100}{100 - C} \right)$$

where:

s_0 [specific volume (ft³/lb)] = specific volume of inert gas agent at 70°F and 14.7 psi absolute

t [temperature (°F)] = design temperature in the hazard area.

s [specific volume (ft³/lb)] = specific volume of IG-100 vapor can be approximated by $s = 11.976 + 0.02606t$, where t = temperature (°F).

C [concentration (%)] = volumetric concentration of IG-100 in air at the temperature indicated.

N A.7.5.3 The leakage and predicted retention time of an enclosure can be determined using the procedure in Annex C, Enclosure Integrity Procedure, or by an alternative method that can be used to obtain an equivalent quantitative result. The currently preferred method is using a blower door fan unit and smoke pencil.

N A.7.6.6 If possible, all air-handling and power-cutoff controls should be of the type that, once interrupted, requires manual restart to restore power.

N A.7.6.9 Refer to *NFPA 72*[®] and the manufacturer's recommended guidelines.

N A.7.6.10 Refer to *NFPA 72*[®] and the manufacturer's recommended guidelines.

N A.7.6.12.4 Particular care should be taken where manual release devices for more than one system are in close proximity and could be confused or the wrong system actuated. Manual stations in this instance should be clearly identified as to which zone or extinguishing area they affect.

N A.7.7.1.3 Personnel at the end user's facility should be instructed as to events that could occur during the functional testing, such as discharge of gas from nozzles during partial flow tests, activation of alarms, and auxiliary functions such as equipment shutdowns.

Table A.5.5.2(d) IG-100 Total Flooding Quantity (SI Units)^a

Temp (<i>t</i>) (°C) ^c	Specific Vapor Volume (<i>s</i>) (m ³ /kg) ^d	Volume Requirements of Agent per Unit Volume of Hazard ($V_{\text{agent}}/V_{\text{enclosure}}$) ^b							
		Design Concentration (% by Volume) ^e							
		34	37	40	42	47	49	58	62
-40	0.6826	0.5225	0.5809	0.6423	0.6849	0.7983	0.8466	1.0908	1.2166
-30	0.7119	0.5009	0.5570	0.6159	0.6567	0.7654	0.8118	1.0459	1.1665
-20	0.7412	0.4811	0.5350	0.5915	0.6308	0.7352	0.7797	1.0045	1.1204
-10	0.7704	0.4629	0.5147	0.5691	0.6069	0.7073	0.7501	0.9664	1.0779
0	0.7997	0.4459	0.4959	0.5482	0.5846	0.6814	0.7227	0.9310	1.0384
10	0.8290	0.4302	0.4783	0.5289	0.5640	0.6573	0.6971	0.8981	1.0017
20	0.8582	0.4155	0.4621	0.5109	0.5448	0.6349	0.6734	0.8676	0.9677
30	0.8875	0.4018	0.4468	0.4940	0.5268	0.6140	0.6512	0.8389	0.9357
40	0.9168	0.3890	0.4325	0.4782	0.5100	0.5943	0.6304	0.8121	0.9058
50	0.9461	0.3769	0.4191	0.4634	0.4942	0.5759	0.6108	0.7870	0.8778
60	0.9753	0.3657	0.4066	0.4495	0.4794	0.5587	0.5925	0.7634	0.8515
70	1.0046	0.3550	0.3947	0.4364	0.4654	0.5424	0.5753	0.7411	0.8266
80	1.0339	0.3449	0.3835	0.4241	0.4522	0.5270	0.5590	0.7201	0.8032
90	1.0631	0.3355	0.3730	0.4124	0.4398	0.5126	0.5436	0.7004	0.7812
100	1.0924	0.3265	0.3630	0.4013	0.4280	0.4988	0.5290	0.6816	0.7602

^aThe manufacturer's listing specifies the temperature range for operation.

^b X [agent volume requirements (m³/m³)] = volume of agent required per cubic meter of protected volume to produce indicated concentration at temperature specified.

Δ

$$X = 2.303 \times \left(\frac{s_0}{s} \right) \times \log_{10} \left(\frac{100}{100 - C} \right) = \left(\frac{s_0}{s} \right) \times \ln \left(\frac{100}{100 - C} \right)$$

where:

s_0 [specific volume (m³/kg)] = specific volume of inert gas agent at 21°C and 1.013 bar absolute

t [temperature (°C)] = design temperature in the hazard area.

s [specific volume (m³/kg)] = specific volume of IG-100 vapor can be approximated by $s = 0.7997 + 0.00293t$, where t = temperature (°C).

C [concentration (%)] = volumetric concentration of IG-100 in air at the temperature indicated.

N A.7.7.1.4 For electrically actuated release mechanisms, functional devices can include 24-V lamps, flashbulbs, or circuit breakers. Pneumatically actuated release mechanisms can include pressure gauges. Refer to the manufacturer's recommendations in all cases.

N A.7.9.2 Training should cover the following:

- (1) Health and safety hazards associated with exposure to extinguishing agent caused by system discharge
- (2) Possible difficulty in escaping spaces with inward swinging doors that are overpressurized due to a system discharge
- (3) Possible obscuration of vision during system discharge
- (4) Need to verify that a clear egress path exists
- (5) A review of how the system could be accidentally discharged

N A.8.2 Monthly inspections could be completed by the owner.

N A.8.3.3 Recovered halocarbon clean agents should not be released into the atmosphere. Halocarbon clean agent containers should not be disposed in any manner that could result in eventual agent release. It is preferable to recycle recovered halogenated clean agents rather than to destroy them. If recovered halogenated agent is found by test to contain contaminants that make it either technically or economically unfeasible

to bring it into compliance with the quality requirements of 4.1.2, the agent should be destroyed in an environmentally acceptable manner.

N A.8.3.4 For inert gas clean agents that are not liquefied, pressure is an indication of agent quantity. Inert gas clean agents based on those gases normally found in the earth's atmosphere need not be recycled.

N A.8.4.2 The service report provides the owner with information pertaining to the fire system, its condition, and any necessary repairs or modifications. The servicing company should review the inspection report to ensure that the necessary data are captured and a safe and thorough inspection is performed. The *FSSA Design Guide for Use with Fire Protection Systems Inspection Forms* can assist in this review and assist a new servicing company in the development of a complete inspection report form.

N A.8.4.5.2 If uncertainty still exists, the enclosure should be retested for integrity in accordance with Section 7.5.

Table A.5.5.2(e) IG-541 Total Flooding Quantity (U.S. Units)^a

Temp (t) (°F) ^c	Specific Vapor Volume (s) (ft ³ /lb) ^d	Volume Requirements of Agent per Unit Volume of Hazard ($V_{\text{agent}}/V_{\text{enclosure}}$) ^b							
		Design Concentration (% by Volume) ^e							
		34	38	42	46	50	54	58	62
-40	9.001	0.524	0.603	0.686	0.802	0.873	0.977	1.096	1.218
-30	9.215	0.513	0.590	0.672	0.760	0.855	0.958	1.070	1.194
-20	9.429	0.501	0.576	0.657	0.743	0.836	0.936	1.046	1.166
-10	9.644	0.490	0.563	0.642	0.726	0.817	0.915	1.022	1.140
0	9.858	0.479	0.551	0.628	0.710	0.799	0.895	1.000	1.116
10	10.072	0.469	0.539	0.615	0.695	0.782	0.876	0.979	1.092
20	10.286	0.459	0.528	0.602	0.681	0.766	0.858	0.958	1.069
30	10.501	0.450	0.517	0.590	0.667	0.750	0.840	0.939	1.047
40	10.715	0.441	0.507	0.578	0.653	0.735	0.824	0.920	1.026
50	10.929	0.432	0.497	0.566	0.641	0.721	0.807	0.902	1.006
60	11.144	0.424	0.487	0.555	0.628	0.707	0.792	0.885	0.987
70	11.358	0.416	0.478	0.545	0.616	0.693	0.777	0.868	0.968
80	11.572	0.408	0.469	0.535	0.605	0.681	0.762	0.852	0.950
90	11.787	0.401	0.461	0.525	0.594	0.668	0.749	0.836	0.933
100	12.001	0.393	0.453	0.516	0.583	0.656	0.735	0.821	0.916
110	12.215	0.386	0.445	0.507	0.573	0.645	0.722	0.807	0.900
120	12.429	0.380	0.437	0.498	0.563	0.634	0.710	0.793	0.884
130	12.644	0.373	0.430	0.489	0.554	0.623	0.698	0.779	0.869
140	12.858	0.367	0.422	0.481	0.544	0.612	0.686	0.766	0.855
150	13.072	0.361	0.415	0.473	0.535	0.602	0.675	0.754	0.841
160	13.287	0.355	0.409	0.466	0.527	0.593	0.664	0.742	0.827
170	13.501	0.350	0.402	0.458	0.518	0.583	0.653	0.730	0.814
180	13.715	0.344	0.396	0.451	0.510	0.574	0.643	0.718	0.801
190	13.930	0.339	0.390	0.444	0.502	0.565	0.633	0.707	0.789
200	14.144	0.334	0.384	0.437	0.495	0.557	0.624	0.697	0.777

^aThe manufacturer's listing specifies the temperature range for operation.

^b X [agent volume requirements (ft³/ft³) = volume of agent required per cubic foot of protected volume to produce indicated concentration at temperature specified.

Δ

$$X = 2.303 \times \left(\frac{s_0}{s} \right) \times \log_{10} \left(\frac{100}{100 - C} \right) = \left(\frac{s_0}{s} \right) \times \ln \left(\frac{100}{100 - C} \right)$$

where:

s_0 [specific volume (ft³/lb)] = specific volume of inert gas agent at 70°F and 14.7 psi absolute

t [temperature (°F)] = design temperature in the hazard area.

s [specific volume (ft³/lb)] = specific volume of IG-541 vapor can be approximated by $s = 9.8579 + 0.02143t$, where t = temperature (°F).

C [concentration (%)] = volumetric concentration of IG-541 in air at the temperature indicated.

NA.8.5 The manufacturer's maintenance procedure should be guided by the following outline:

- (1) System
 - (a) Check overall physical appearance.
 - (b) Disarm system prior to test.
- (2) Hazard
 - (a) Determine size.
 - (b) Determine configuration.
 - (c) Check for unclosable openings.
 - (d) Determine fuels.
 - (e) Determine other aspects of the hazard that could impair effectiveness of the extinguishing systems.
- (3) Supervised circuits
 - (a) Exercise all functions.
 - (b) Check all electrical or pneumatic supervisory circuits for operation.
- (4) Control panel
 - (a) Exercise all functions.
- (b) Check supervision, if applicable, of each circuit (including releasing devices) as recommended by the manufacturer.
- (5) Power supply
 - (a) Check routing, circuit breakers, fuses, disconnects.
- (6) Emergency power
 - (a) Check battery condition.
 - (b) Check charger operation; check fuse.
 - (c) Check automatic changeover.
 - (d) Check maintenance of generator (if one exists).
- (7) Detectors
 - (a) Test each detector using heat, smoke, or manufacturer's approved test device. (*See NFPA 72®.*)
 - (b) Electric type.
 - (i) Clean and adjust smoke detector and check sensitivity.
 - (ii) Check wiring condition.
 - (c) Pneumatic type: Check tightness of tubing and operation of mercury checks, using manometer.

Table A.5.5.2(f) IG-541 Total Flooding Quantity (SI Units)^a

Temp (<i>t</i>) (°C) ^c	Specific Vapor Volume (<i>s</i>) (m ³ /kg) ^d	Volume Requirements of Agent per Unit Volume of Hazard ($V_{\text{agent}}/V_{\text{enclosure}}$) ^b							
		Design Concentration (% by Volume) ^e							
		34	38	42	46	50	54	58	62
-40	0.562	0.524	0.602	0.686	0.776	0.873	0.978	1.093	1.219
-30	0.586	0.502	0.578	0.658	0.745	0.838	0.938	1.048	1.169
-20	0.610	0.482	0.555	0.633	0.716	0.805	0.902	1.007	1.124
-10	0.634	0.464	0.534	0.609	0.689	0.775	0.868	0.969	1.081
0	0.659	0.447	0.515	0.587	0.664	0.746	0.836	0.934	1.042
10	0.683	0.432	0.497	0.566	0.640	0.720	0.807	0.901	1.005
20	0.707	0.417	0.480	0.547	0.619	0.696	0.780	0.871	0.971
30	0.731	0.403	0.464	0.529	0.598	0.673	0.754	0.842	0.940
40	0.755	0.391	0.449	0.512	0.579	0.652	0.730	0.816	0.910
50	0.779	0.379	0.436	0.496	0.562	0.632	0.708	0.791	0.882
60	0.803	0.367	0.423	0.482	0.545	0.613	0.687	0.767	0.855
70	0.827	0.357	0.410	0.468	0.529	0.595	0.667	0.745	0.831
80	0.851	0.347	0.399	0.455	0.514	0.578	0.648	0.724	0.807
90	0.875	0.337	0.388	0.442	0.500	0.563	0.630	0.704	0.785
100	0.900	0.328	0.378	0.430	0.487	0.548	0.613	0.685	0.764

^a The manufacturer's listing specifies the temperature range for operation.

^b X [agent volume requirements (m³/m³) = volume of agent required per cubic meter of protected volume to produce indicated concentration at temperature specified.

Δ

$$X = 2.303 \times \left(\frac{s_0}{s} \right) \times \log_{10} \left(\frac{100}{100 - C} \right) = \left(\frac{s_0}{s} \right) \times \ln \left(\frac{100}{100 - C} \right)$$

where:

s_0 [specific volume (m³/kg)] = specific volume of inert gas agent at 21°C and 1.013 bar absolute

t [temperature (°C)] = design temperature in the hazard area.

s [specific volume (m³/kg)] = specific volume of IG-541 vapor can be approximated by $s = 0.65799 + 0.00239t$, where t = temperature (°C).

C [concentration (%)] = volumetric concentration of IG-541 in air at the temperature indicated.

- | | |
|---|---|
| <p>(8) Time delay</p> <p>(a) Exercise functions.</p> <p>(b) Check time limit.</p> <p>(c) Check that timer will complete its cycle even though wiring between it and the detector circuit is interrupted.</p> <p>(9) Alarms</p> <p>(a) Test for operation (audible and visual).</p> <p>(b) Check to see that warning signs are displayed in accordance with the system documentation.</p> <p>(10) Selector (directional) valves</p> <p>(a) Exercise functions.</p> <p>(b) Reset properly.</p> <p>(11) Release devices</p> <p>(a) Check for complete closure of dampers.</p> <p>(b) Check doors; check for any doors blocked open.</p> <p>(12) Equipment shutdown</p> <p>(a) Test shutdown function.</p> <p>(b) Check adequacy (all necessary equipment included).</p> <p>(13) Manual releases</p> <p>(a) Mechanical type.</p> <p>(i) Check pull, force, and length of pull required.</p> | <p>(ii) Operate and adjust all devices.</p> <p>(iii) Check tightness of connectors.</p> <p>(iv) Check condition of conduit.</p> <p>(v) Check condition and operation of corner pulleys.</p> <p>(b) Electric type.</p> <p>(a) Test manual release.</p> <p>(b) Check that covers are in place.</p> <p>(c) Check pneumatic releases.</p> <p>(d) Check accessibility during fire.</p> <p>(e) Separate main and reserve manual pulls that require only one operation, to obtain discharge of either main or reserve supply of gas.</p> <p>(f) Clearly mark and identify all manual releases.</p> <p>(14) Piping</p> <p>(a) Check security; check that piping is adequately supported.</p> <p>(b) Check condition; check for any corrosion.</p> <p>(15) Nozzles</p> <p>(a) Check orientation and orifice size; make sure they are unchanged from original design.</p> <p>(b) Check cleanliness.</p> <p>(c) Check security.</p> <p>(d) Check seals where needed.</p> |
|---|---|

▲ Table A.5.5.2(g) IG-55 Total Flooding Quantity (U.S. Units)^a

Temp (t) (°F) ^c	Specific Vapor Volume (s) (ft ³ /lb) ^d	Volume Requirements of Agent per Unit Volume of Hazard ($V_{\text{agent}}/V_{\text{enclosure}}$) ^b							
		Design Concentration (% by Volume) ^e							
		34	38	42	46	50	54	58	62
-40	9.02108	0.524	0.603	0.688	0.778	0.875	0.980	1.095	1.221
-30	9.23603	0.512	0.589	0.672	0.760	0.854	0.957	1.069	1.193
-20	9.45099	0.501	0.576	0.656	0.742	0.835	0.935	1.045	1.166
-10	9.66594	0.489	0.563	0.642	0.726	0.816	0.915	1.022	1.140
0	9.88090	0.479	0.551	0.628	0.710	0.799	0.895	1.000	1.115
10	10.09586	0.469	0.539	0.614	0.695	0.782	0.876	0.978	1.091
20	10.31081	0.459	0.528	0.602	0.680	0.765	0.857	0.958	1.068
30	10.52577	0.449	0.517	0.589	0.667	0.750	0.840	0.938	1.047
40	10.74073	0.440	0.507	0.577	0.653	0.735	0.823	0.920	1.026
50	10.95568	0.432	0.497	0.566	0.640	0.720	0.807	0.902	1.006
60	11.17064	0.424	0.487	0.555	0.628	0.706	0.791	0.884	0.986
70	11.38560	0.416	0.478	0.545	0.616	0.693	0.777	0.868	0.968
80	11.60055	0.408	0.469	0.535	0.605	0.680	0.762	0.851	0.950
90	11.81551	0.400	0.461	0.525	0.594	0.668	0.748	0.836	0.932
100	12.03046	0.393	0.452	0.516	0.583	0.656	0.735	0.821	0.916
110	12.24542	0.386	0.444	0.506	0.573	0.644	0.722	0.807	0.900
120	12.46038	0.380	0.437	0.498	0.563	0.633	0.710	0.793	0.884
130	12.67533	0.373	0.429	0.489	0.553	0.623	0.698	0.779	0.869
140	12.89029	0.367	0.422	0.481	0.544	0.612	0.686	0.766	0.855
150	13.10525	0.361	0.415	0.473	0.535	0.602	0.675	0.754	0.841
160	13.32020	0.355	0.409	0.466	0.527	0.592	0.664	0.742	0.827
170	13.53516	0.350	0.402	0.458	0.518	0.583	0.653	0.730	0.814
180	13.75012	0.344	0.396	0.451	0.510	0.574	0.643	0.718	0.801
190	13.96507	0.339	0.390	0.444	0.502	0.565	0.633	0.707	0.789
200	14.18003	0.334	0.384	0.437	0.495	0.557	0.623	0.697	0.777

Note: V_s = the term $X = \ln [100/(100 - C)]$ gives the volume at a rated concentration (%) and temperature to reach an air-agent mixture at the end of flooding time in a volume of 1 ft³.

^aThe manufacturer's listing specifies the temperature range for operation.

^b X [agent volume requirements (lb/ft³)] = volume of agent required per cubic foot of protected volume to produce indicated concentration at temperature specified.

▲

$$X = 2.303 \times \left(\frac{s_0}{s}\right) \times \log_{10}\left(\frac{100}{100 - C}\right) = \left(\frac{s_0}{s}\right) \times \ln\left(\frac{100}{100 - C}\right)$$

where:

s_0 [specific volume (ft³/lb)] = specific volume of inert gas agent at 70°F and 14.7 psi absolute

t [temperature (°F)] = design temperature in the hazard area.

s [specific volume (ft³/lb)] = specific volume of IG-55 vapor can be approximated by $s = 9.8809 + 0.0215t$, where t = temperature (°F).

C [concentration (%)] = volumetric concentration of IG-55 in air at the temperature indicated.

(16) Containers

- (a) Check physical condition; check for any sign of corrosion.
- (b) Check the contents for weight by acceptable methods for each container. If the contents are below the required quantity specified in 8.3.2 and 8.3.3, then the containers must be refilled or replaced. (Operation of the liquid level gauge should be verified.)
- (c) Check that containers are securely held in position.
- (d) Check hydrostatic test date.
- (e) Check container connectors for integrity and condition.
- (f) Check weights and cables of mechanical release system.

- (g) Check release devices; check for arrangement in accordance with the system documentation and security.

- (h) Check explosive release devices; check replacement date; check condition.

(17) Test

- (a) Perform recommended discharge tests when there is any question about the adequacy of the system.
- (b) Perform recommended full discharge test when container hydrostatic test is required.

(18) Return all parts of system to full service.

(19) Give certificate of inspection to owner.

- (a) The owner should maintain the certificate on file.
- (b) Regular service contracts with the manufacturer or installing company are recommended. Work should be performed by personnel thoroughly trained and regularly engaged in providing such service.

Table A.5.5.2(h) IG-55 Total Flooding Quantity (SI Units)^a

Temp (<i>t</i>) (°C) ^c	Specific Vapor Volume (<i>s</i>) (m ³ /kg) ^d	Volume Requirements of Agent per Unit Volume of Hazard ($V_{\text{agent}}/V_{\text{enclosure}}$) ^b							
		Design Concentration (% by Volume) ^e							
		34	38	42	46	50	54	58	62
-40	0.56317	0.524	0.603	0.688	0.778	0.875	0.980	1.095	1.221
-35	0.56324	0.513	0.591	0.673	0.761	0.856	0.959	1.072	1.196
-30	0.58732	0.503	0.579	0.659	0.746	0.839	0.940	1.050	1.171
-25	0.59940	0.493	0.567	0.646	0.731	0.822	0.921	1.029	1.147
-20	0.61148	0.483	0.556	0.633	0.716	0.806	0.903	1.008	1.125
-15	0.62355	0.474	0.545	0.621	0.702	0.790	0.885	0.989	1.103
-10	0.63563	0.465	0.535	0.609	0.689	0.775	0.868	0.970	1.082
-5	0.64771	0.456	0.525	0.598	0.676	0.761	0.852	0.952	1.062
0	0.65979	0.448	0.515	0.587	0.664	0.747	0.837	0.935	1.042
5	0.67186	0.440	0.506	0.576	0.652	0.733	0.822	0.918	1.024
10	0.68394	0.432	0.497	0.566	0.640	0.720	0.807	0.902	1.006
15	0.69602	0.424	0.488	0.556	0.629	0.708	0.793	0.886	0.988
20	0.70810	0.417	0.480	0.547	0.619	0.696	0.779	0.871	0.971
25	0.72017	0.410	0.472	0.538	0.608	0.684	0.766	0.856	0.955
30	0.73225	0.403	0.464	0.529	0.598	0.673	0.754	0.842	0.939
35	0.74433	0.397	0.456	0.520	0.588	0.662	0.742	0.828	0.924
40	0.75641	0.390	0.449	0.512	0.579	0.651	0.730	0.815	0.909
45	0.76848	0.384	0.442	0.504	0.570	0.641	0.718	0.802	0.895
50	0.78056	0.378	0.435	0.496	0.561	0.631	0.707	0.790	0.881
55	0.79264	0.373	0.429	0.488	0.553	0.622	0.696	0.778	0.868
60	0.80471	0.367	0.422	0.481	0.544	0.612	0.686	0.766	0.855
65	0.81679	0.362	0.416	0.474	0.536	0.603	0.676	0.755	0.842
70	0.82887	0.356	0.410	0.467	0.528	0.594	0.666	0.744	0.830
75	0.84095	0.351	0.404	0.460	0.521	0.586	0.656	0.733	0.818
80	0.85302	0.346	0.398	0.454	0.513	0.578	0.647	0.723	0.806
85	0.86510	0.341	0.393	0.448	0.506	0.569	0.638	0.713	0.795
90	0.87718	0.337	0.387	0.441	0.499	0.562	0.629	0.703	0.784
95	0.88926	0.332	0.382	0.435	0.493	0.554	0.621	0.693	0.773
100	0.90133	0.328	0.377	0.430	0.486	0.547	0.612	0.684	0.763

^aThe manufacturer's listing specifies the temperature range for operation.

^b X [agent volume requirements (m³/m³)] = volume of agent required per cubic meter of protected volume to produce indicated concentration at temperature specified.

Δ

$$X = 2.303 \times \left(\frac{s_0}{s} \right) \times \log_{10} \left(\frac{100}{100 - C} \right) = \left(\frac{s_0}{s} \right) \times \ln \left(\frac{100}{100 - C} \right)$$

where:

s_0 [specific volume (m³/kg)] = specific volume of inert gas agent at 21°C and 1.013 bar absolute

t [temperature (°C)] = design temperature in the hazard area.

s [specific volume (m³/kg)] = specific volume of IG-55 vapor can be approximated by $s = 0.6598 + 0.00242t$, where t = temperature (°C).

C [concentration (%)] = volumetric concentration of IG-55 in air at the temperature indicated.

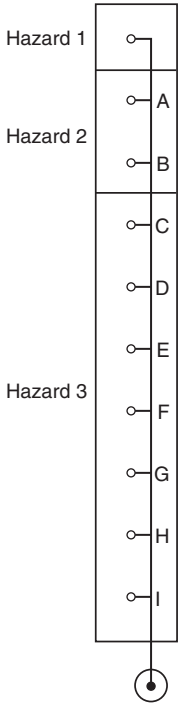

FIGURE A.5.5.3.1(a) Piping for Design Factor Tee Count for Example 1.

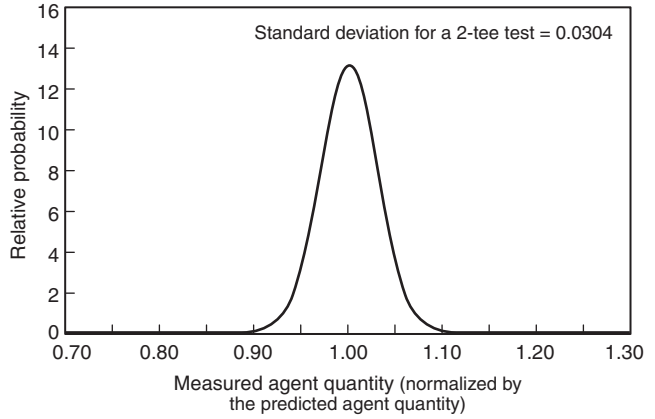

FIGURE A.5.5.3.2(a) Normal Distribution Curve.

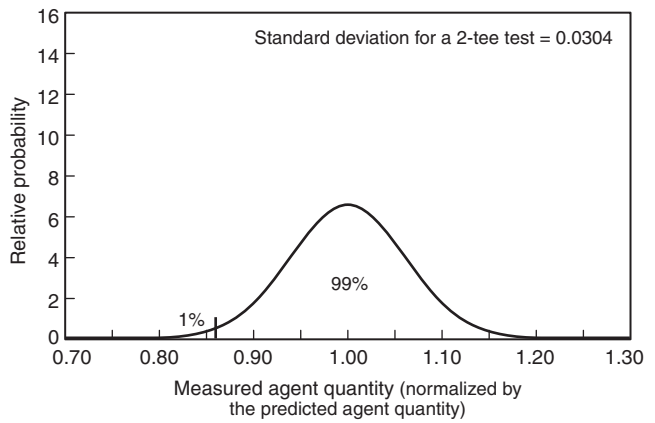

FIGURE A.5.5.3.2(b) Distribution Curve No. 1.

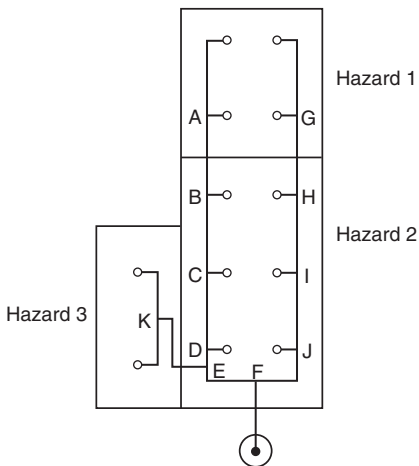

FIGURE A.5.5.3.1(b) Piping for Design Factor Tee Count for Example 2.

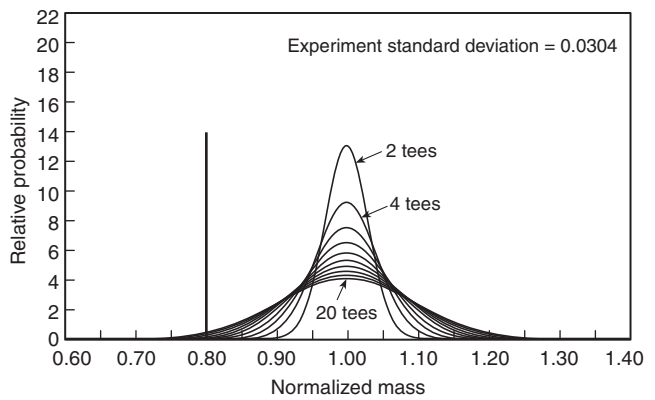

FIGURE A.5.5.3.2(c) Distribution Curve No. 2.

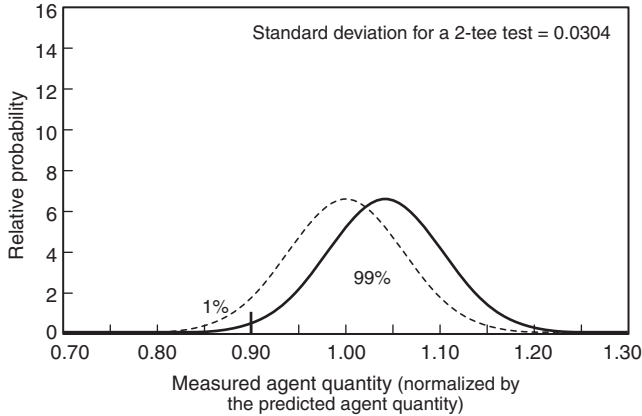

FIGURE A.5.5.3.2(d) Distribution Curve No. 3.

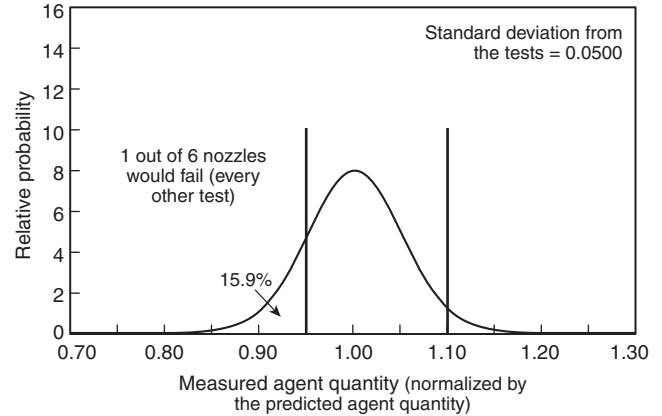

FIGURE A.5.5.3.2(g) Distribution Curve No. 6.

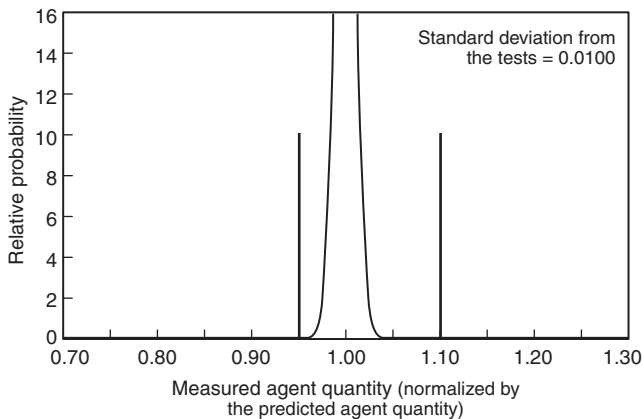

FIGURE A.5.5.3.2(e) Distribution Curve No. 4.

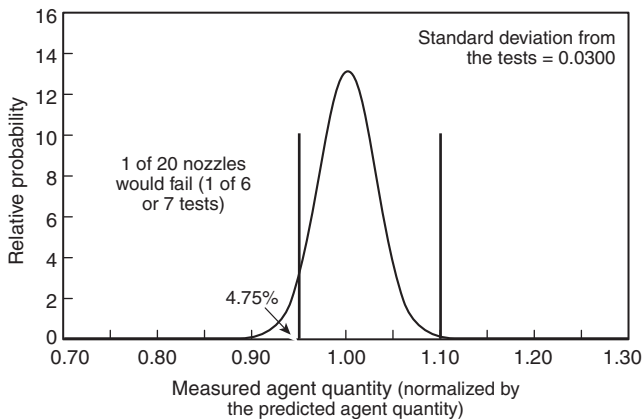

FIGURE A.5.5.3.2(f) Distribution Curve No. 5.

■ **A.8.5.4.1** The method of sealing should not introduce any new hazards.

■ **A.8.6** The Fire Suppression Systems Association has prepared a guide that provides essential information on the regulatory requirements for transportation and requalification of containers used in clean agent fire extinguishing systems. FSSA's *Test Guide for Use with Special Hazard Fire Suppression Systems Containers* will assist service personnel to determine the required test and requalification of the system container.

■ **A.8.6.1** Federal and local regulations should be consulted for requirements concerning transportation of containers.

■ **A.8.6.2** These guidelines apply only to the external inspection of containers continuously in service in the fire extinguishing system and should not be confused with the DOT retest requirements for visual inspection described in 49 CFR. Recordkeeping is an important part of every inspection. The inspector should be guided by the following outline to ensure that the minimum information is recorded:

- (1) *Record tag.* A record tag should be attached to every container being inspected for future reference. The record tag should be marked with date of inspection (month/year), name of individual(s) and company performing the inspection, container serial number, condition of the container (paint, corrosion, dents, gouges, etc.), and disposition.
- (2) *Inspection report.* The following information should be recorded on an inspection report: date of inspection (month/year), name of individual(s) and company performing the inspection, DOT specification number, container serial number, date of manufacture, date of previous inspection and/or test, type of protective coating, surface condition (corrosion, dents, gouges, fire damage, etc.), and disposition (satisfactory, repaint, repair, scrap, etc.). A sample of a suitable inspection report form can be found in Appendix A of CGA C-6.

■ **A.8.7.6** If heat is used for drying, the temperature should not exceed the manufacturer's specification.

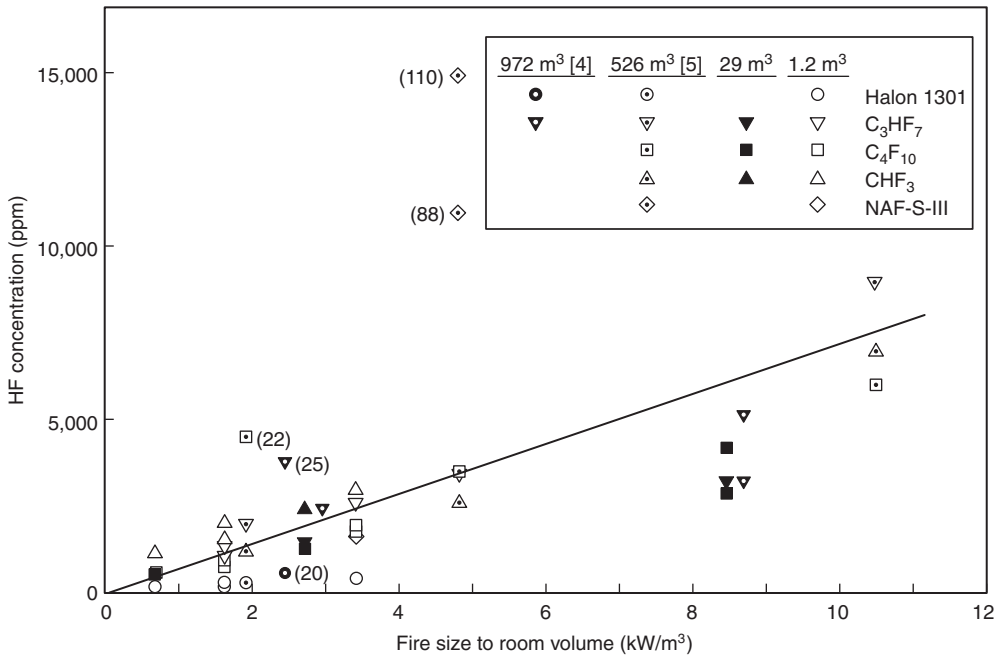

Extinguishment times (seconds) are given in brackets for fires that took longer than 17 seconds to extinguish. If more than one fire was utilized, the longer extinguishment time is given.

FIGURE A.5.7.1.1(a) Peak HF Concentrations.

A.9.2.1 Some typical hazards that could be suitable include, but are not limited to, the following:

- (1) Machinery spaces such as main machinery spaces
- (2) Emergency generator rooms
- (3) Pump rooms
- (4) Flammable liquid storage and handling areas and paint lockers
- (5) Control rooms and electronic equipment spaces

A.9.2.2 General cargo should not be protected with halocarbon agents due to the possibility of deep-seated cargo fires and due to wide variations in cargo materials. Dry cargoes, such as containerized cargoes, often comprise a wide mix of commodities that can include materials or storage arrangements not suited for protection with halocarbon agents. The volume of agent needed to protect cargo spaces varies depending on the volume of the cargo space minus the volume of the cargo carried. This quantity varies as cargo volume changes and can affect fire extinguishing effectiveness or agent toxicity.

A.9.3.2 Subchapter J of 46 CFR 111.59 requires busways to comply with Article 368 of *NFPA 70*. Article 368 requires compliance with Article 300 for clearances around busways.

A.9.4.2 Agent cylinder storage spaces should be adequately ventilated. Entrances to such spaces should be from an open deck.

A.9.4.6 Corrosion resistance is required to prevent clogging of nozzles with scale. Examples of suitable materials are hot dipped galvanized steel piping inside and out or stainless steel.

A.9.4.7 Fittings conforming to ASTM F1387 and fire tested with zero leakage conform to the requirements of 9.4.7.

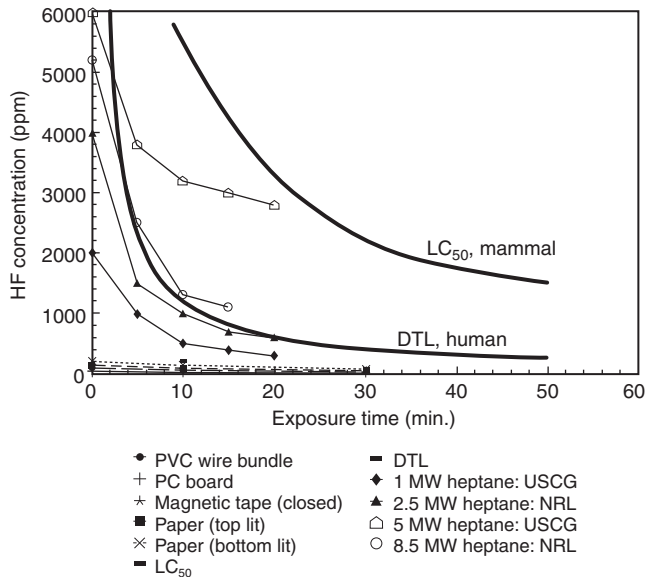

FIGURE A.5.7.1.1(b) Hazard Assessment of HF Concentrations. Extinguishment of Typical EDP and Class B Hazards with 7 Percent HFC-227ea.

Clean Agent System Acceptance Test Report			
PROCEDURE			
Upon completion of work, an inspection and test shall be made by the contractor's representative and witnessed by an owner's representative. All defects shall be corrected and the system left in service before the contractor's personnel leave the job. A certificate shall be filled out and signed by both representatives. Copies shall be prepared for approving authorities, owners, and contractor. It is understood the owner's representative's signature in no way prejudices any claim against the contractor for faulty material, poor workmanship, or failure to comply with approving authority's requirements or local ordinances.			
Property name		Date	
Property address			
Plans	Accepted by approving authorities (names)		
	Address		
	Installation conforms to accepted plans	<input type="checkbox"/> Yes	<input type="checkbox"/> No
	Equipment used is approved	<input type="checkbox"/> Yes	<input type="checkbox"/> No
	If no, state deviations		
Instructions	Person in charge of fire equipment has been instructed as to location of control valves and care and maintenance of this new equipment	<input type="checkbox"/> Yes	<input type="checkbox"/> No
	If no, explain		
	Copies of appropriate instructions and care and maintenance charts have been left on premises	<input type="checkbox"/> Yes	<input type="checkbox"/> No
	If no, explain		
Enclosure	Enclosure in conformance with construction documents	<input type="checkbox"/> Yes	<input type="checkbox"/> No
	If no, explain		
	Enclosure integrity report received and approved	<input type="checkbox"/> Yes	<input type="checkbox"/> No
Mechanical equipment	System type	<input type="checkbox"/> Total flooding	<input type="checkbox"/> Local app.
	Agent storage containers properly located (in accordance with approved system drawings)	<input type="checkbox"/> Yes	<input type="checkbox"/> No
	Storage containers and mounting brackets fastened securely	<input type="checkbox"/> Yes	<input type="checkbox"/> No
	Piping, equipment, and discharge nozzles proper size and location	<input type="checkbox"/> Yes	<input type="checkbox"/> No
	Pipe size reduction and tee fitting position in conformance with design drawings	<input type="checkbox"/> Yes	<input type="checkbox"/> No
	Piping joints, discharge nozzles, and pipe supports securely fastened	<input type="checkbox"/> Yes	<input type="checkbox"/> No
	Discharge nozzle orientation in conformance with approved design drawings	<input type="checkbox"/> Yes	<input type="checkbox"/> No
	Nozzle deflectors (if installed) orientation in conformance with approved design drawings	<input type="checkbox"/> Yes	<input type="checkbox"/> No
	Location of alarms and manual emergency releases acceptable	<input type="checkbox"/> Yes	<input type="checkbox"/> No
	Current hazard configuration comparable to original configuration	<input type="checkbox"/> Yes	<input type="checkbox"/> No
	Enclosure test report received	<input type="checkbox"/> Yes	<input type="checkbox"/> No
	All installed equipment listed for use	<input type="checkbox"/> Yes	<input type="checkbox"/> No
Electrical equipment	Proper operation verified for all auxiliary functions including alarm-sounding or displaying devices, remote annunciators, air-handling shutdown, and power shutdown	<input type="checkbox"/> Yes	<input type="checkbox"/> No
	Main/reserve transfer switch installed properly, readily accessible, and clearly identified	<input type="checkbox"/> Yes	<input type="checkbox"/> No
	Type and location of all detection devices verified	<input type="checkbox"/> Yes	<input type="checkbox"/> No
	Manual pull stations installed properly, readily accessible, accurately identified, and protected to prevent damage	<input type="checkbox"/> Yes	<input type="checkbox"/> No
Pipe and fittings	Piping pneumatically tested to 40 psi (276 kPa) for 10 minutes	<input type="checkbox"/> Yes	<input type="checkbox"/> No
	Pipe conforms to Standard	<input type="checkbox"/> Yes	<input type="checkbox"/> No
	Fittings conform to Standard	<input type="checkbox"/> Yes	<input type="checkbox"/> No
	If no, explain		
Pre-functional tests	Each detector checked for proper response	<input type="checkbox"/> Yes	<input type="checkbox"/> No
	Polarity verified for all polarized alarm devices and auxiliary relays	<input type="checkbox"/> Yes	<input type="checkbox"/> No
	EOL resistors installed across all alarm and detection circuits (where required)	<input type="checkbox"/> Yes	<input type="checkbox"/> No
	Proper trouble response verified for all supervised circuits	<input type="checkbox"/> Yes	<input type="checkbox"/> No
© 2017 National Fire Protection Association		NFPA 2001 (p.1 of 2)	

▲ FIGURE A.7.3.1 Sample Acceptance Test Report.

Clean Agent System Acceptance Test Report (Continued)			
Operational test	Puff test completed and continuous flow and unobstructed piping and nozzles verified	<input type="checkbox"/> Yes <input type="checkbox"/> No	
	Alarm functions verified following detection initiation	<input type="checkbox"/> Yes <input type="checkbox"/> No	
	Manual release functions according to design specifications	<input type="checkbox"/> Yes <input type="checkbox"/> No	
	Abort switch functions according to design specifications	<input type="checkbox"/> Yes <input type="checkbox"/> No	
	Automatic valves tested and operation verified	<input type="checkbox"/> Yes <input type="checkbox"/> No	
	All pneumatic equipment tested and verified	<input type="checkbox"/> Yes <input type="checkbox"/> No	
	Full operational test for single or multiple hazards	<input type="checkbox"/> Yes <input type="checkbox"/> No	
	Weight before and after discharge	_____ lb _____ kg	
	For inert gas systems — pressure before and after discharge	_____ psi _____ kPa	
	Remote Monitoring	<input type="checkbox"/> Yes <input type="checkbox"/> No	
	Alarm signal from each input device on stand-by owner verified	<input type="checkbox"/> Yes <input type="checkbox"/> No	
	Trouble signal verified for each alarm condition on each signal circuit	<input type="checkbox"/> Yes <input type="checkbox"/> No	
	Control panel primary power source	<input type="checkbox"/> Yes <input type="checkbox"/> No	
	Control panel connected to a dedicated circuit	<input type="checkbox"/> Yes <input type="checkbox"/> No	
	Control panel labeled properly	<input type="checkbox"/> Yes <input type="checkbox"/> No	
	Control panel readily accessible	<input type="checkbox"/> Yes <input type="checkbox"/> No	
	Control panel secured from unauthorized access	<input type="checkbox"/> Yes <input type="checkbox"/> No	
	System returned to fully operational design condition	<input type="checkbox"/> Yes <input type="checkbox"/> No	
	Signatures	Name of installing contractor: _____	
		Tests witnessed by:	
For property owner: _____		Title: _____ Date: _____	
For contractor: _____		Title: _____ Date: _____	
Notes:			
© 2017 National Fire Protection Association NFPA 2001 (p. 2 of 2)			

▲ FIGURE A.7.3.1 *Continued*

A.9.5.1.2 The intent of this paragraph is to ensure that a suppression system will not interfere with the safe navigation of the vessel. Many internal combustion propulsion engines and generator prime movers draw combustion air from the protected space in which they are installed. Because these types of engines are required to be shut down prior to system discharge, an automatically discharged system would shut down propulsion and electricity supply when needed most. A nonautomatic system gives the ship's crew the flexibility to decide the best course of action. For example, in a high-density shipping channel, a ship's ability to maneuver can be more important than immediate system discharge. For small vessels, the use of automatic systems is considered appropriate, taking into consideration the vessel's mass, cargo, and crew training.

A.9.5.2.3 The intent is to prevent accidental or malicious system operation. Some examples of acceptable manual actuation stations are the following:

- (1) Breaking a glass enclosure and pulling a handle
- (2) Breaking a glass enclosure and opening a valve
- (3) Opening an enclosure door and flipping a switch

A.9.6.1 Heat detectors are typically used in machinery spaces and are sometimes combined with smoke detectors. Listed or approved optical flame detectors can also be used, provided

they are in addition to the required quantity of heat and/or smoke detectors.

A.9.6.2 This requirement is derived from SOLAS Regulation II-2/Regulation 5.3.

A.9.6.3 This requirement is derived from SOLAS Regulation II-2/Regulation 5.3.

A.9.6.4 This requirement is derived from SOLAS Regulation II-2/Regulation 5.3.

A.9.6.5 This requirement is derived from SOLAS Regulation II-2/Regulation 5.3.

A.9.6.6 This requirement is derived from SOLAS Regulation II-2/Regulation 5.3.

A.9.7.1 A well-sealed enclosure is vital to proper operation of the system and subsequent extinguishment of fires in the protected space. Gastight boundaries of the protected space, such as those constructed of welded steel, offer a highly effective means for holding the fire extinguishing gas concentration. Where the space is fitted with openings, avenues for escape of the gas exist. Automatic closure of openings is the preferred method of ensuring enclosure integrity prior to discharge. Manually closed openings introduce added delay

and an added human element into the chain of proper operation of the system. Failure of personnel to properly close all openings has been a recurring cause of gaseous systems not performing as intended. It is recognized that some openings in the enclosures, such as maintenance hatches and watertight doors, cannot be fitted with automatically operated closers due to personnel hazards or other limitations. In those cases, an indicator is required to alert the system operator that an opening has not been closed as required and thus the system is not ready for operation.

A.9.7.2 Automatic shutdowns are the preferred method for shutting down a ventilation system. Shutdowns requiring personnel to find and manually close dampers far from the fire extinguishing system discharge station should not be permitted.

A.9.8.4 When the net volume of the machinery space is being calculated, the net volume should include the volume of the bilge and the volume of the stack uptake. The volume calculation should be permitted to exclude the portions of the stack uptake that have a horizontal cross-sectional area less than 40 percent of the horizontal cross-sectional area of the main machinery space. The horizontal cross-sectional area of the main machinery space should be measured midway between the lowest level (tank top) and the highest level (bottom of the stack casing). (See *Figure A.9.8.4*.)

The objects that occupy volume in the protected space should be subtracted from the volume of the space. These objects include, but are not necessarily limited to, the following:

- (1) Auxiliary machinery
- (2) Boilers
- (3) Condensers
- (4) Evaporators
- (5) Main engines
- (6) Reduction gears
- (7) Tanks
- (8) Trunks

The Maritime Safety Committee, at its 67th session (December 2–6, 1996), approved guidelines for the approval of equivalent fixed gas fire extinguishing systems, as referred to in SOLAS 74, for machinery spaces and cargo pump rooms, as MSC/Circ. 776.

The Subcommittee on Fire Protection, at its 42nd session (December 8–12, 1997), recognized the need for technical improvement to the guidelines contained in MSC/Circ. 776 to assist in their proper implementation and, to that effect, prepared amendments to the guidelines.

The committee, at its 69th session (May 11–20, 1998), approved revised guidelines for the approval of equivalent fixed gas fire extinguishing systems, as referred to in SOLAS 74, for machinery spaces and cargo pump rooms, as set out in the annex, to supersede the guidelines attached to MSC/Circ. 776.

Member governments are invited to apply the annexed guidelines when approving equivalent fixed gas fire extinguishing systems for use in machinery spaces of category A and cargo pump rooms.

The quantity of extinguishing agent for the protected space should be calculated at the minimum expected ambient temperature using the design concentration based on the net volume of the protected space, including the casing.

The net volume of a protected space is that part of the gross volume of the space that is accessible to the free extinguishing agent gas.

In the calculation of the net volume of a protected space, the net volume should include the volume of the bilge, the volume of the casing, and the volume of free air contained in air receivers that in the event of a fire is released into the protected space.

The objects that occupy volume in the protected space should be subtracted from the gross volume of the space. They include, but are not necessarily limited to, the following:

- (1) Auxiliary machinery
- (2) Boilers
- (3) Condensers
- (4) Evaporators
- (5) Main engines
- (6) Reduction gears
- (7) Tank
- (8) Trunks

Subsequent modifications to the protected space that alter the net volume of the space require the quantity of extinguishing agent to be adjusted to meet the requirements of [9.8.4](#) and [9.8.5](#).

No fire suppression agent should be used that is carcinogenic, mutagenic, or teratogenic at concentrations expected during use. No agent should be used in concentrations greater than the cardiac sensitization NOAEL, without the use of controls as provided in SOLAS Regulation II-2/Regulations 5.2. In no case should an agent be used above its LOAEL nor approximate lethal concentration (ALC) calculated on the net volume of the protected space at the maximum expected ambient temperature.

A.9.8.5 Maintaining the design concentration is equally important in all classes of fires because a persistent ignition source, such as an electric arc, boiler front, heat source, engine exhaust, turbo charger, hot metal, or deep-seated fire, can lead to resurgence of the initial event once the clean agent has dissipated.

A.9.11.3 For determination of container pressure, the original container fill density should be obtained from the system manufacturer and the temperature/pressure relation should be obtained from tables published by the system manufacturer. For determination of container liquid level, the liquid level–temperature relationship should be obtained from the system manufacturer.

A.9.11.3.1 For inert gas clean agents that are not liquefied, pressure is an indication of agent quantity.

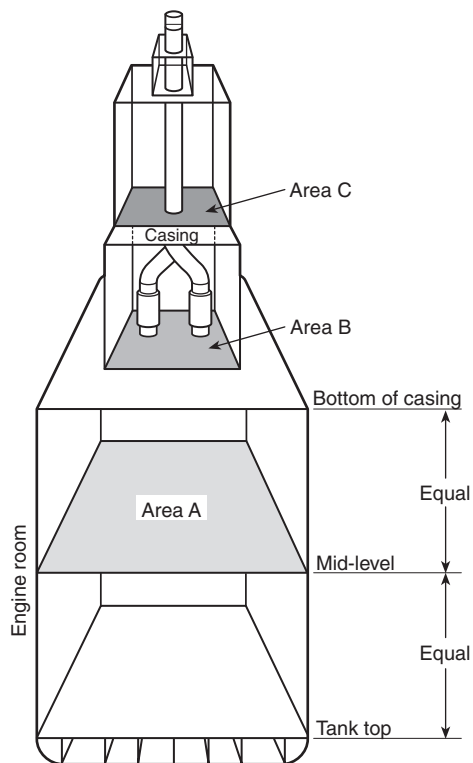

For the casing to be considered separate from the gross volume of the machinery space, Area B must be 40 percent or less of Area A.

If Area B is greater than 40 percent of Area A, the volume of casing up to Area C (or where the area is 40 percent or less of Area A) must be included in the gross volume of the space.

Any area of the casing containing boilers, internal combustion machinery, or oil-fired installations must be included in the gross volume of the engine room.

FIGURE A.9.8.4 Machinery Space and Stack Uptake.

Annex B Cup Burner Method for Determining the Minimum Concentration of Gaseous Agent for Flame Extinguishment

This annex is not a part of the requirements of this NFPA document but is included for informational purposes only.

B.1 Introduction. Total flooding fire extinguishing systems are widely used for protection of enclosures where flammable materials, including liquids and gases, are processed or stored.¹ The fire extinguishing agent used in such a system can be a gas or a liquid under storage conditions. When released into the atmosphere of the protected space, the agent disperses, evaporating if initially a liquid, to form a mixture of air and gaseous agent. Successful fire suppression occurs when the agent concentration exceeds the minimum extinguishing concentration (MEC) by a sufficient margin, or safety margin, to cause rapid flame extinguishment. Use of excessive quantities of agent may be undesirable for reasons related to total system cost or, often more important, the need to avoid creating an agent-air atmosphere that is harmful to people due to hypoxia, agent toxicity, or both. In the case of flammable liquid hazards, the minimum design concentration (MDC) of a gaseous agent is specified in national and international standards as the MEC

times a safety factor. This test method uses the cup burner to determine, for a given fuel, the MEC of a gaseous agent. The cup burner method is inherently empirical. The theoretical and parametric aspects of flame extinguishment in this procedure have been addressed by many authors and is the subject of ongoing research. A few recent references are given in the endnotes to this annex.^{2,3,4}

B.2 Scope. Diffusion flames of fuels burning in a round reservoir (cup) centrally positioned in a coaxially flowing air stream are extinguished by addition of a gaseous extinguishant to the air.

B.2.1 This test method provides a standard measure of minimum flame extinguishing concentration of a gaseous extinguishing agent for flames of flammable or combustible liquids and flammable gases.⁵

B.2.2 This method has value as a means of meeting the requirements of national and international standards for determination of the minimum design concentration of a gaseous agent.

B.2.3 This method is applicable to gaseous fire extinguishing agents that can be introduced into the test apparatus as a gas that is uniformly mixed in air.

B.2.4 This test method is applicable to liquid fuels that have adequate fluidity at the test temperature to allow accurate liquid level control in the cup. The method may be difficult to use with very viscous fuels.

B.2.5 This method is applicable to fuels that are ignitable at the operating temperature of the cup.

B.2.6 The values stated in SI units are to be regarded as the standard. The values given in parentheses are for information only.

B.2.7 This test method does not purport to address all of the safety concerns, if any, associated with its use. It is the responsibility of the user of this test method to establish appropriate safety and health practices and to determine the applicability of regulatory limitations prior to use.

B.3 Referenced Documents. The following publications should be referenced:

ASTM E176, *Standard Terminology of Fire Standards*

ASTM E177, *Standard Practice for Use of the Terms Precision and Bias in ASTM Test Methods*

ASTM E456, *Standard Terminology Relating to Quality and Statistics*

ASTM E691, *Standard Practice for Conducting an Interlaboratory Study to Determine the Precision of a Test Method*

ISO 14520, *Gaseous fire-extinguishing systems — Physical properties and system design — Part 1: General requirements*

ANSI/UL 2127, *Standard for Inert Gas Clean Agent Extinguishing System Units*

ANSI/UL 2166, *Standard for Halocarbon Clean Agent Extinguishing System Units*

B.4 Terminology.

B.4.1 Definitions. For definitions used in this test method, refer to Chapter 3 and ASTM E176.

B.4.2 Definitions of Terms Specific to the Cup Burner Method.

B.4.2.1 Agent. Fire extinguishing gas that, when added to air in sufficient quantity, causes extinguishment of the test flame. Agents consisting of noncondensable gases, vapors of liquefied compressed gases, and vapors of volatile liquids are in commercial use.

B.4.2.1.1 Primary Reference Agent. Nitrogen; minimum purity 99.9 percent.

B.4.2.1.2 Secondary Reference Agent. Agent more nearly similar to the study agent in extinguishing concentration for the reference fuel than nitrogen.⁶

B.4.2.1.3 Study Agent. Agent that is the subject of study in the cup burner.

B.4.2.2 Chimney. Transparent tube, usually glass, that contains the cup and confines air and agent flow.

B.4.2.3 Cup. Fuel reservoir and flame stabilizer.

B.4.2.4 Extinguishing Concentration. The concentration of agent in air that causes extinguishment of the test flame within the observation period.

B.4.2.5 Extinguishment. Cessation of combustion above the cup.

B.4.2.6 Flow Straightener. Mechanical means of establishing nonturbulent uniform vertical flow at the base of the chimney.

B.4.2.7 Fuel. Flammable or combustible liquid or flammable gas supplied to the cup.

B.4.2.7.1 Reference Fuel.

B.4.2.7.1.1 Gaseous Reference Fuel. Methane⁷; minimum purity 99 percent.

B.4.2.7.1.2 Liquid Reference Fuel. n-Heptane; minimum purity 99 percent.

B.4.2.7.2 Study Fuel. Fuel for which an extinguishing concentration of an agent is to be determined.

B.4.2.8 Lifted Flame. Flame for which the base becomes lifted above the cup rim by at least 10 mm at any nonextinguishing agent concentration. The occurrence of lifted flames should be noted in the test report.

B.4.2.9 Minimum Extinguishing Concentration (MEC). The lowest value of extinguishing concentration determined by this method.

B.4.2.10 Observation Period. A period of at least 10 seconds after change in agent flow rate.

B.4.2.11 Pre-Burn Time. Period between ignition of fuel and start of agent flow. The pre-burn time should be 80 seconds \pm 20 seconds.⁸

B.5 Summary of Test Method.

B.5.1 Air is delivered to the base of the chimney. The measurements necessary for determining the air flow rate are recorded.

B.5.2 The air stream passes through a flow straightener to establish uniformly distributed flow and reduce turbulence.

B.5.3 A flame of the test fuel is established at the cup. For a liquid fuel, the liquid level in the cup is maintained within prescribed limits. The flow rate of a gaseous fuel is kept at a fixed value.

B.5.4 The flame is allowed to burn in air for a prescribed period of time, the pre-burn time.

B.5.5 Agent is added to the air stream in steps. The measurements necessary for determining the agent flow rate, agent concentration in air, or other relevant data are recorded as appropriate to the specific method of agent flow control.

B.5.6 After each change in agent flow rate, the effect of the agent-air mixture on the flame is observed. If the flame is extinguished during the observation period, the result is recorded as an extinguishing condition and the determination is concluded. Otherwise, the agent flow rate is then increased.

B.5.7 The extinguishing concentration for each determination is calculated or otherwise determined from the data.

B.5.8 At least five determinations of extinguishing concentration are made exclusive of initial trials conducted for the purpose of determining the approximate extinguishing point.

B.5.9 The results of the several determinations of extinguishing concentration are analyzed statistically and reported.

B.6 Significance and Use.

B.6.1 This test method provides a means to determine the MEC in air of a gaseous agent to extinguish flames of liquid and gaseous fuels.

B.6.2 An MEC value determined by this method is specific to the apparatus and procedure employed herein. The minimum concentration of agent in air necessary to extinguish combustion of the same fuel under other laboratory or field conditions may be different from that determined by this method.

B.6.3 The MEC determined by this method can be used as a basis of determining minimum agent design concentration for a total flooding application in accordance with the requirements of relevant standards for total flooding fire extinguishing systems. In particular, this method meets the requirements of NFPA 2001 for determining the MEC of an agent for a Class B liquid fuel.

B.7 Interferences.

B.7.1 Fuel Character. Some fuels change character in the cup during the test as a consequence of distillation, chemical reaction, precipitation of solids, or by other means. In such cases, the extinguishing concentration determined by this method might not accurately reflect the fuel in its most-difficult-to-extinguish form.

B.7.2 Air. Some laboratories employ compressed “air” supplied in cylinders by a commercial source. In such instances, the “air” must be certified as compressed atmospheric air. Some commercially supplied “air” is prepared by blending previously separated oxygen and nitrogen. The oxygen concentration in such mixtures can deviate significantly from 20.95 mol %, the sea level composition of dry air. Deviation of oxygen concentration from the standard value in supplied “air” will have an effect on the measured extinguishing concentration of the agent. Additionally, the argon content of prepared “air” can deviate from the 0.93 mol % sea level value. Argon has a significantly lower thermal conductivity than nitrogen, and, as such, argon excess or deficiency could have a measurable effect on the apparent extinguishing of an agent.

B.7.3 Barometric Pressure.⁹

B.7.4 Deposits on Cup Rim. Deposits can cause the liquid fuel to wick down the outside of the cup, making the flame burn from the outside of the cup as well as from the inside.

B.7.5 Humidity. Water vapor is an inert gas fire extinguishing agent. The temperature and relative humidity of air supplied to the chimney should be measured and recorded.

B.7.6 Fuel Overflow. Fuel overflow from the cup into the chimney base invalidates the test.

B.8 Safety Precautions.

B.8.1 Pressurized Equipment. Extinguishing agents may be supplied in pressurized cylinders. Caution must be exercised securing pressurized cylinders, tubing, valves, and fittings.

B.8.2 Combustion Product Ventilation. Combustion products are, in general, hazardous. They can contain carbon monoxide, soot, and partial combustion products, the toxicity of which depends on the fuel chemistry. When halogenated extinguishing agents are tested, combustion produces halogen acids, such as HF, HCl, HBr, and HI, and carbonyl compounds, such as COF₂ and COCl₂. An adequate means of ventilation must be employed to exhaust combustion products away from the work space.

B.8.3 General Fire Hazard. There is an attendant general flammable liquids fire hazard associated with conducting cup burner tests. Test technicians should understand this hazard and be trained to respond appropriately in the event of a fuel spill or uncontrolled fuel ignition.

B.9 Apparatus.

B.9.1 Cup Burner Apparatus. The basic cup burner apparatus consists of the following elements: base assembly, chimney, cup, and flow straightener.

B.9.1.1 Base Assembly. The base assembly securely supports the chimney, cup, and flow straightener. The base assembly has the following provisions:

- (1) To admit air and agent to a plenum below the flow straightener
- (2) To admit fuel to the cup liquid connection
- (3) For electrical connections or other means of cup heating
- (4) For thermocouples or other temperature measuring means

B.9.1.2 Chimney. The chimney consists of a standard 90 mm ± 1.3 mm OD glass tube with 2.4 mm ± 0.3 mm wall thickness suitable for high temperature use.¹⁰ The overall chimney tube

length is sufficient to accommodate the following minimum dimensions:

- (1) Flow straightener to cup rim: 250 mm (nominal)
- (2) Cup rim to top of chimney: 300 mm (nominal)

B.9.1.3 Fuel Supply.

B.9.1.3.1 Liquid Fuel Reservoir. Liquid fuel should be supplied from a reservoir that permits adjustment of the liquid fuel height in the cup. In one method, fuel is supplied by gravity flow from a reservoir mounted on a means of adjusting its height, such as on a laboratory jack stand. The fuel reservoir should be several times larger in diameter than the cup to minimize change in the fuel liquid level during a test. Several methods are available for maintaining a constant reservoir liquid level.

B.9.1.3.2 Gaseous Fuel Supply.

B.9.1.4 Cup.

B.9.1.4.1 Body. The cup should be made of quartz or other glass suitable for high temperature use. The nominal dimensions of the cup at the top are OD = 31 mm and ID = 26 mm. The cup rim has an internal chamfer of approximately 45 degrees.

B.9.1.5 Cup Preparation for Gaseous Fuels. When gaseous fuels are used, it is necessary to place packing material or screening in the cup in such a manner as to facilitate uniform fuel gas flow across the exit face of the cup. There is discretion on how this is achieved.¹¹

B.9.1.5.1 Heating Element. A means of heating liquid fuel in the cup can be incorporated by any method that does not cause localized boiling of liquid fuel on the heating surface. Suitable methods include a heating element immersed in the fuel (fully below liquid surface) or a heating element within the glass wall of the cup.

B.9.1.5.2 Temperature Measurement. A means of measuring fuel temperature prior to ignition is needed. An in situ thermocouple (below the liquid surface) for fuel temperature measurement during a test can prove convenient.

B.9.1.6 Flow Straightener. The flow straightener is a means of ensuring uniform nonturbulent upward air velocity at the base of the chimney. A suitable flow straightener can employ a bed of glass beads above the air inlet plenum or other flow-straightening materials.

B.9.2 Gas Flow Rates and Agent Concentration Measurement.

B.9.2.1 Air Supply.

B.9.2.1.1 Air Flow Rate.

B.9.2.1.1.1 Air Flow Regulation. The arrangement for delivering air to the cup burner should include a means of regulating the flow rate.

B.9.2.1.1.2 Air Flow Rate Measurement. The rate of flow of air to the cup burner should be measured using a calibrated apparatus. Types of apparatus commonly used for this purpose include, but are not restricted to, rotameters and mass flow meters.

B.9.2.1.2 Humidity. Air supplied to the cup burner should be dry.¹²

B.9.2.2 Agent.**B.9.2.2.1 Agent Flow Rate.**

B.9.2.2.1.1 Agent Flow Regulation. The arrangement for delivering agent to the cup burner should include a means of regulating the flow rate.

B.9.2.2.1.2 Agent Flow Rate Measurement. The rate of flow of agent to the cup burner should be measured using a calibrated apparatus. Types of apparatus commonly used for this purpose include, but are not restricted to, rotameters and mass flow meters.

B.9.2.2.1.3 Agent Concentration Measurement. Where the concentration of agent in the agent-air mixture is determined by measurement, the method of such measurement should be calibrated.

B.9.2.2.2 Liquid Agent. The method employed to deliver and vaporize an agent that is a liquid at ambient conditions should be reported.

B.9.2.2.3 Agent Concentration. Direct measurement of agent concentration in the agent-air stream is measured using any of several possible methods, including, but not limited to, the following:

- (1) Gas chromatographic, infrared absorption or other type of analysis of discrete air-agent samples
- (2) Continuous sampling and measurement by detector based on thermal conductivity, infrared absorption, or other measuring principle

B.9.2.2.4 Oxygen Concentration. Agent concentration can, in some instances, be inferred with sufficient accuracy from determination of the oxygen concentration in the agent-air mixture. Oxygen concentration in gases is commonly measured using methods based on paramagnetic or electrochemical sensors. Interference effects, if any, of agent gas on oxygen concentration measurement must be determined and accounted for.

B.9.3 Gaseous Fuel. Measurement of gaseous fuel flow rate can be made with any of several type of flow meters, including rotameters, mass flow meters, bubble flow meters, or other means.

B.10 Calibration and Standardization.

B.10.1 Measuring equipment should be calibrated on a regular basis and whenever test conditions indicate that recalibration is necessary.

B.10.2 The measurement uncertainty or the precision of measuring equipment should be determined and recorded.

B.10.3 The vertical alignment of the chimney should be verified periodically. A spirit level should suffice for this purpose.

B.10.4 The cup should be aligned vertically and be concentric with the axis of the chimney.

B.10.5 Flow-regulating valves, where used, should be sized for the anticipated flow rate and should not leak at the pressurized connections.

B.10.6 System Calibration. System calibration tests should be conducted using n-heptane (reference fuel) and at least two reference agents.

B.10.6.1 Primary Reference Agent. Nitrogen should be employed as the primary reference agent.

B.10.6.2 Second Reference Agent. The second reference agent should be selected from among those for which consensus data are available and that have extinguishing performance nearer to the study agent.

B.10.6.3 Calibration Interval. The interval between system calibrations should be short enough to ensure that measurable changes in results are detected and causes identified and corrected.

B.10.7 Standardization.

B.10.7.1 Evaluation of a study fuel with a reference agent should include a standardization test using a reference fuel with the reference agent.

B.10.7.2 Evaluation of a study agent with a reference fuel should include a standardization test using a reference agent with a reference fuel.

B.10.7.3 Evaluation of a study agent with a study fuel should include the two following standardization tests:

- (1) A reference agent test using a reference agent with the study fuel
- (2) A reference fuel test using the study agent with a reference fuel

B.11 Test Specimens.

B.11.1 Air. Air should be supplied as compressed natural air filtered (for oil mist, particulate matter, and moisture condensate) either from a local compressor drawing in fresh ambient air or from high pressure cylinders of certified compressed air. Air prepared by remixing previously separated oxygen and nitrogen should not be used.

B.11.2 Fuel. The fuel should be of a certified type and purity.

B.11.3 Agent. The agent should be of a certified type and purity or composition.

B.12 Conditioning.

B.12.1 Laboratory Temperature. Tests should be conducted at ambient laboratory temperature, nominally in the range of 20°C to 25°C.

B.12.2 Fuel Temperature. Fuel in the cup should be brought to a temperature of 20°C to 25°C or 5°C ± 1°C above its open cup flash point, whichever is higher.

B.12.3 Barometric Pressure. Barometric pressure should be measured and recorded.

B.13 Procedure.**B.13.1 Liquid Fuels.**

B.13.1.1 Air flow is established in the chimney at 40 L/min ± 2 L/min at laboratory ambient conditions.¹³

B.13.1.2 Liquid fuel is admitted to the cup, bringing the liquid level to about 5 to 10 mm below the cup rim.

B.13.1.3 The temperature of the fuel is adjusted as required by B.12.2.

B.13.1.4 The fuel is ignited.

B.13.1.5 Measurement of the pre-burn time is begun.

B.13.1.6 At the start of the pre-burn period, the liquid level of the fuel is raised to within 1 mm of the cup rim or as close to the rim as is practicable without overflowing the cup. The fuel liquid level is to be maintained at this position during the test.

B.13.1.7 At the end of the pre-burn time, agent addition is begun.

B.13.1.8 Agent Addition.

B.13.1.8.1 Agent is added to the air flow in steps. After each change in agent flow rate, the flame is observed long enough to make measurements, but not less than 10 seconds, before the agent flow rate is increased.

B.13.1.8.2 Begin flow of extinguishing agent. Increase the flow rate of extinguishing agent in a stepwise manner until flame extinguishment occurs. A brief interval (about 10 seconds) should be allowed between changes in flow rate. As the extinguishing point is approached, the size of increments in agent flow rate should be as small as practicable. Final flow rate adjustments should be the size of the smallest scale division of the measuring apparatus. The means of flow regulation and measurement should allow for adjustments in flow rate of 2 percent or less of the total flow rate at extinguishment.

B.13.1.8.3 If the flame is not extinguished during the 10-second observation period, then the agent flow rate is increased. This step is repeated until flame extinguishment occurs.

B.13.1.8.4 The agent flow rate at extinguishment is **recorded**.¹⁴

B.13.1.9 The temperature of the fuel at the time of extinguishment can be measured and recorded. In some cases, this supplementary information can be helpful in the analysis of results.

B.13.1.10 At the conclusion of each test, the fuel liquid level should be lowered several millimeters. A pipette should be used to remove at least 10 mL of liquid fuel from the top of the cup to remove decomposition products of both the fuel and the agent and, where the fuel is a mixture, to remove fuel concentrated in species of higher boiling point due to preferential evaporation of lighter species at the surface.

B.13.1.11 Number of Test Trials. A determination of extinguishing concentration should be based on results from at least five (5) test trials in sequence, exclusive of initial trials, conducted for the purpose of determining the approximate extinguishing point.

B.13.2 Gaseous Fuels.

B.13.2.1 Air flow is established in the chimney to achieve a nominal air velocity at the cup-chimney annulus of 13.6 cm/sec \pm 0.7 cm/sec (volumetric air flow rate of \approx 40 L/min \pm 2 L/min in an 85 mm ID chimney with a cup diameter of 31 mm) at laboratory conditions of pressure and temperature.

B.13.2.2 Air temperature and humidity are measured and recorded.

B.13.2.3 Gaseous fuel is admitted to the cup and ignited.

B.13.2.4 Fuel Flow Rate and Flame Size. The fuel gas flow rate is adjusted to achieve a visible flame height of about 75 mm to 85 mm.¹⁵

B.13.2.5 Measurement of pre-burn time is begun.

B.13.2.6 At the end of the pre-burn time, agent addition is begun.

B.13.2.7 Agent Addition.

B.13.2.7.1 Agent is added to the air flow in steps. After each change in agent flow rate, the flame is observed for a period long enough to make measurements, but not less than 10 seconds, before increasing the agent flow rate.

B.13.2.7.2 Addition of agent to the air stream is begun. Where the approximate extinguishing point is known, the initial agent flow rate can be brought to about 80 percent of that value. Subsequent increases in agent flow rate should be no more than 2 percent. The agent flow rate or other characteristic measure of agent concentration should be recorded at each adjustment of agent flow as the extinguishing point is approached. Experience and judgment will determine how small agent flow adjustments should be at any point during the test and when to record such pre-extinguishment data.

B.13.2.7.3 If the flame is not extinguished during the 10 second observation period, the agent flow rate is then increased. This step is repeated until flame extinguishment occurs.

B.13.2.7.4 The agent flow rate at extinguishment is **recorded**.¹⁴

B.13.2.8 At the conclusion of each test, the cup rim should be checked for deposits (soot) and cleaned if required.

B.13.2.9 Number of Test Trials. A determination of extinguishing concentration should be based on results from at least five (5) test trials in sequence, exclusive of preliminary ranging trials.

B.14 Agent Concentration.

B.14.1 General. The concentration of interest is that of the agent gas in the agent-air mixture. Concentration is often expressed as "volume percent," but this is not strictly correct, because concentration is actually a measure of quantity of substance per unit volume (e.g., mol/L or g/L). Volume percent is a measure of the volume fraction of an air-agent mixture that consists of agent gas. This measure is convenient in practice and is not discouraged as long as it is determined correctly. Caution is recommended in cases where the density of agent vapor, either pure or diluted in air, departs measurably from that of an ideal gas of the same molecular weight. It is recommended that concentration be calculated as mole fraction or mole percent. The supplier of each agent can guide users about conversion to volume percent for use in fire extinguishing system design.

B.14.2 Flow Rate Methods.

B.14.2.1 Volumetric Flow Rate. Volumetric flow rate air or agent, measured using calibrated flow meters, should be converted to molar flow rate by multiplying by the gas density and dividing by the agent mean molecular weight. To determine the density of some agent gases, it may be necessary to consult the physical property data (table or equation of state) supplied by the manufacturer.

B.14.2.2 Mass Flow Rate. Where a calibrated mass flow rate measuring device is used, the mass flow rate is converted to the molar flow rate by dividing by the molecular weight:

$$N = \text{molar flow rate} = \text{mass flow rate} / \text{molecular weight}$$

B.14.2.3 The mole fraction, X_G , of agent in the agent-air mixture is calculated as follows:

$$X_G = \frac{N_G}{N_G + N_{Air}}$$

[B.14.2.3]

where:

N_G = molar flow rate of gas

N_{Air} = molar flow rate of air

B.14.2.4 The agent concentration in mole percent is calculated as follows:

$$\text{Mole \% of Agent} = 100X_G$$

B.14.3 Direct Gas Analysis Method. Any of several types of gas analyzers can be calibrated with prepared agent-air mixtures of known composition.

B.14.3.1 Continuous Sampling Analyzer. If the analyzer is of the continuous sampling type, the gas analyzer can then be used to measure the agent concentration in a sample of air-agent mixture drawn from the flowing stream during the test, particularly just before and just after flame extinguishment.

B.14.3.2 Discrete Sample Analyzer. Agent concentration can be determined by analysis of a sample of the agent-air mixture in a gas chromatograph or other calibrated gas analyzer.

B.14.4 Oxygen Analyzer Measurement Method. The concentration of agent in an agent-air mixture can be calculated from a measurement of oxygen concentration in the mixture. Dry atmospheric air consists of 20.95 mole % oxygen. The concentration of a diluting ideal gas (agent) is given by the following equation:

$$\% \text{ Agent} = \left(1 - \frac{\% \text{O}_2}{20.95} \right) \times 100$$

[B.14.4]

If the source air is not atmospheric air, the actual oxygen concentration of the source air (in volume or mole %) should be substituted for 20.95 in the equation. It should be verified that the agent gas does not have an interference effect oxygen analyzer response.

B.14.5 Statistics. The results of the separate determinations of extinguishing concentration should be used to determine average and standard deviation.

B.15 Test Report.

B.15.1 The test report should contain the following information:

- (1) Apparatus description
- (2) Summary of test procedure and exceptions

- (3) Date of report
- (4) Fuel name and grade
- (5) Agent type and composition
- (6) Test conditions, including the following:
 - (a) Barometric pressure
 - (b) Laboratory temperature or temperature of air entering the base of the chimney, if different from laboratory temperature
 - (c) Humidity of air supplied to chimney
- (7) Air flow rate at test conditions
- (8) Fuel temperature calculated using the following steps:
 - (a) Fuel temperature measured and recorded prior to ignition
 - (b) Fuel temperature measured and recorded at flame extinguishment
- (9) Agent flow rate at test conditions, if measured
- (10) Gas analyzer measurements, if used
- (11) Sample calculation of agent concentration
- (12) Summary table of results, including the following:
 - (a) Data for each combination of agent and fuel tested, including results of the following:
 - i. Calibration tests
 - ii. Standardization tests
 - iii. Study tests
 - (b) Sample statistics, including the following:
 - i. Number of measurements, n
 - ii. Average extinguishing concentration (see B.15.2 for the method of calculating this concentration)
 - iii. Standard deviation (see B.15.3)
- (13) Comparison of study results with standardization
- (14) Notes on exceptions in the apparatus, procedure, and analysis

B.15.2 Average extinguishing concentration can be calculated using the following equation:

[B.15.2]

$$\bar{x} = \frac{1}{n} \sum_{i=1}^n x_i$$

B.15.3 Standard deviation can be calculated using the following equation:

[B.15.3]

$$s = \sqrt{\frac{\sum_{i=1}^n (x_i - \bar{x})^2}{(n-1)}}$$

B.16 Precision and Bias.

B.16.1 Precision.

B.16.1.1 Repeatability. (Reserved)

B.16.1.2 Reproducibility. (Reserved)

B.16.2 Bias. (Reserved)**B.17 Keywords. (Reserved)****B.18 Notes.****Δ B.18.1 Endnotes.**

¹The large majority of total flooding fire extinguishing systems are used for protection of Class A fire hazards such as data centers, clean rooms, telephone central offices, and control rooms. These occupancies do not normally contain Class B fire hazards.

²Preece, S., P. Mackay, and A. Chattaway, *The Cup Burner Method — A Parametric Analysis of the Factors Influencing the Reported Extinguishing Concentrations of Inert Gases*, Proceedings of the Halon Options Technical Working Conference. April 24–26, 2001, Albuquerque, NM.

³Senecal, J. A., *Flame Extinguishing by Inert Gases: Theoretical and Experimental Analysis*, Proceedings of the 2004 Technical Meeting of the Central States Section of the Combustion Institute, Austin, TX, March 21–22, 2004.

⁴Takahashi, F., G. T. Linteris, and V. R. Katta, *Suppression of Cup-Burner Flames*, Fourth International Symposium on Scale Modeling (ISSM-IV), Cleveland, OH, September 17–19, 2003.

⁵Flames of gaseous fuels behave differently than do flames of liquids in this test. Gaseous fuel flow is fixed at the start of the test. Liquid fuel vapor flow decreases as the extinguishing point is approached due to reduction in heat transfer rate. Also see Linteris, G. T., *Suppression of Cup-Burner Flames by Super-Effective Chemical Inhibitors and Inert Compounds*, Proceedings of the Halon Options Technical Working Conference, April 24–26, 2001, Albuquerque, NM, pp. 187–196. Figures 1 and 2 illustrate the relationship of liquid fuel consumption rate and agent concentration.

⁶CO₂ might serve well as a secondary reference agent, because it is readily available and has an extinguishing concentration approximately two-thirds that of nitrogen, thereby establishing a significant span that is useful in establishing benchmark performance.

⁷F. Takahashi commented: “Methane, a main ingredient of natural gas, is favorable because its reaction mechanism is most known and thus most widely used in combustion research. Accurate numerical predictions can be made with full chemistry. However, as Irv Glassman has frequently mentioned, methane (C₁) is unique kinetically compared to higher hydrocarbons. Ethane (C₂) represents kinetics of higher hydrocarbons more closely as they decompose to smaller HCs and the oxidation reaction pathway is ethane to ethylene then to acetylene. When I was in Dayton (UDRI, on-site at WPAFB), Sandia, NM, specifically requested us to use ethane as the fuel for the extinguishing nitrogen concentration measurement in step-stabilized flames. Propane is another popular fuel and attractive for research use, although it (C₃) is also somewhat unique kinetically. Therefore, methane and propane may be practically reasonable, but ethane may be more scientifically sound.” (July 8, 2004)

⁸The specification in Annex B of the 2004 edition of NFPA 2001 is “90 to 120 s” for liquids and 60 sec for gases. At the recommendation of the VdS (Germany), ISO TC 21/SC 8 opted, in September 2003, for a 60 s pre-burn time for liquid fuels and a 60 s pre-burn time, with no tolerance, for gaseous

fuels. In technical collaboration among those experienced in performing this test it was agreed that the value of MEC for liquid fuels is not sensitive to variation in pre-burn time in the 60 to 100 s time period.

⁹It has yet to be demonstrated whether barometric pressure variation from 101.3 Pa affects results obtained in this test. A controlled experimental effort is needed.

¹⁰The specified chimney dimensions are standard and available in Pyrex[®] and Kimax[®] brand tubes.

¹¹Takahashi et al. (2003) filled the cup with 3 mm glass beads and placed two layers of 40 mesh screen on top.

¹²A systematic study showed that for one halocarbon agent, the extinguishing concentration was linearly related to the humidity of the supplied air. The MEC for 100 percent RH air (~21°C) was ~11 percent (relative) less than that determined for ~0 percent RH air. (P. Mackay memorandum, 18 May 2004.) In addition, analysis (J. A. Senecal, July 2004) of humidity effects on inert gas (nitrogen) extinguishment indicates that feasible variations in humidity of air supplied to the cup burner can affect the extinguishing concentration, X_G. Specifically, it is estimated that in the two extremes of (a) dry air and (b) 70 percent RH air at 25°C, the variation in X_G is approximately 0.313 < X_G < 0.295, or 6 percent, which is at least twice the estimated uncertainty of the measurement. An RH correction to results may be necessary.

¹³The air flow rate should be 40 L/min ± 2 L/min, which, for the standard chimney and cup configuration specified herein, corresponds to a superficial linear velocity in the cup-chimney annulus of 13.5 cm/sec ± 0.7 cm/sec. The air flow rate should be adjusted in consideration of the actual chimney and cup dimensions to achieve the same nominal annular air velocity.

The literature discusses a “plateau” region in the air flow rate (i.e., a range of air velocities over which the MEC value is invariant, or nearly so). Most investigators report that the plateau for halocarbon agents is usually at or near 40 L/min. It is also reported that there is no plateau for inert gas agents and that the MEC value creeps up with increasing air velocity.

¹⁴The goal is to determine the agent concentration at the extinguishing point. Methods that do not use direct measurement of agent flow rate are permitted. For example, composition analysis of agent-air mixture is acceptable.

¹⁵Takahashi et al. (2003) studied a methane flame. They used an air flow velocity of 10.7 cm/sec (volumetric rate of ~36 L/min) and a methane cup-exit velocity of 0.92 cm/sec (flow rate ~0.34 L/min), which corresponds to an overall equivalence ratio of about 0.090 (i.e., about 900 percent excess air for complete combustion). The uninhibited flame height was ~75 mm.

B.18.2 Additional Notes. See *Handbook of Chemistry and Physics*, 83rd ed., D. R. Lide, editor, Ch. 14, p. 19, “U.S. Standard Atmosphere (1976),” CRC Press LLC (2002).

Δ B.19 Figures. Figure B.19(a) through Figure B.19(f) and Table B.19 illustrate critical components for use in fabricating a standard cup burner system.

Table B.19 Cup Burner System Major Components

Component	Specifications	Supplier
Cup-burner base	Design: Per Figure B.19(d) Material: Brass	Custom fabrication
Cup-burner base support plate	Design: Per Figure Figure B.19(e) Material: Brass	Custom fabrication
Chimney	90 mm OD × 85 mm ID × 520 mm (nominal) Material: Quartz	National Scientific Company, Inc., 205 East Paletown Road, P.O. Box 498, Quakertown, PA 18951
Cup	Design: Per Figure B.19(c) Material: Quartz	G. Finkenbeiner Inc., 33 Rumford Ave., Waltham, MA 02453, or other laboratory glass fabricator
Adapter, NPT to glass tube	Swagelock p/n SS-8-UT-1-6, SS Ultra-Torr Male Connector, ½ in. female vacuum seal fitting – ⅜ in. MNPT	Cambridge Valve & Fitting, Inc., 50 Manning Road, Billerica, MA 01821
Diffuser bead support screen	Design: Per Figure B.19(f) Material: McMaster-Carr p/n 9358T131. Type 304 stainless steel perforated sheet 36 in. × 40 in., 0.0625 in. hole dia, 23% open area, 22 gauge	Custom fabrication
Diffuser bed beads	Diameter: 3 mm Material: Glass	Fisher Scientific p/n 11-312A
Gasket, chimney-base	Buna-N Square O-ring cord stock, ⅛ in. fractional size	McMaster-Carr p/n 9700K121
Support plate legs (4)	Standoff–4.38 in. (11 mm) × 0.63 in. (16 mm) dia. ½-13 UNC	Common
Connector screws, support plate-to-base (3)	Bolt – Hex cap, ⅝-18 × 0.5 in. (M8 × 1.25, Length 12 mm)	Common
Support plate-to-base spacer sleeves	p/n M37 9 mm OD × 89 mm Material: Brass Custom cut to finish	K & S Engineering, 6917 West 59th Street, Chicago, IL 60638

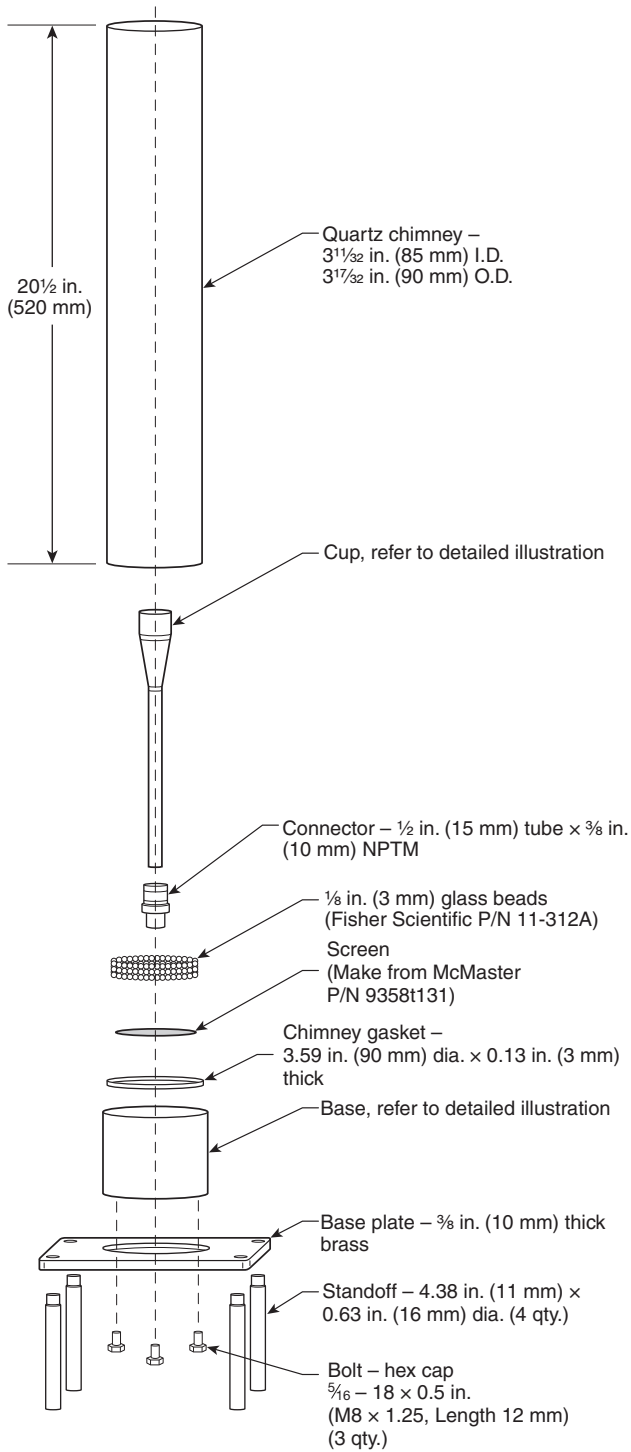

▲ FIGURE B.19(a) Cup Burner Assembly (Exploded View).

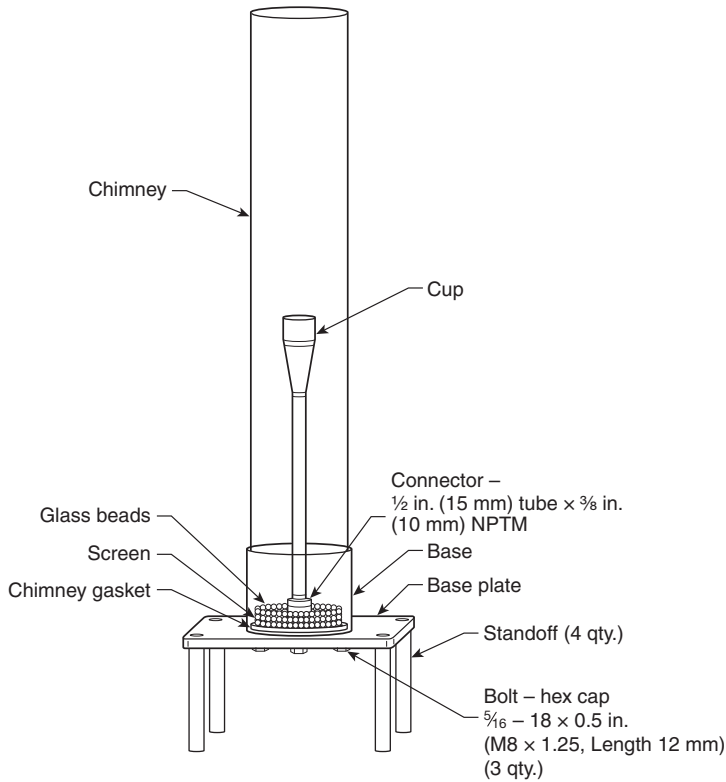

▲ FIGURE B.19(b) Cup Burner Assembly (Transparent View).

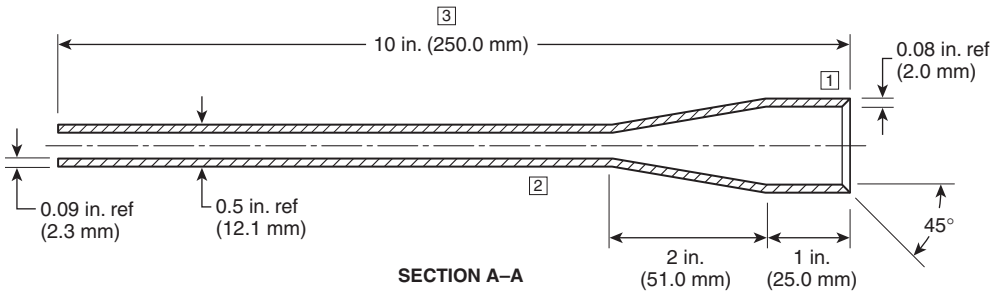

Notes:

1. Cut 45° to as close to knife point as possible.
2. All transitions should be smooth.
3. All non-reference dimensions are nominal.

Source:

G. Finkenbeiner Inc.
33 Rumford Ave.
Waltham, MA 02453

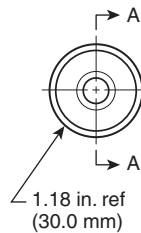

▲ FIGURE B.19(c) Cup Material: Quartz [Dimensions in Inches (Millimeters)].

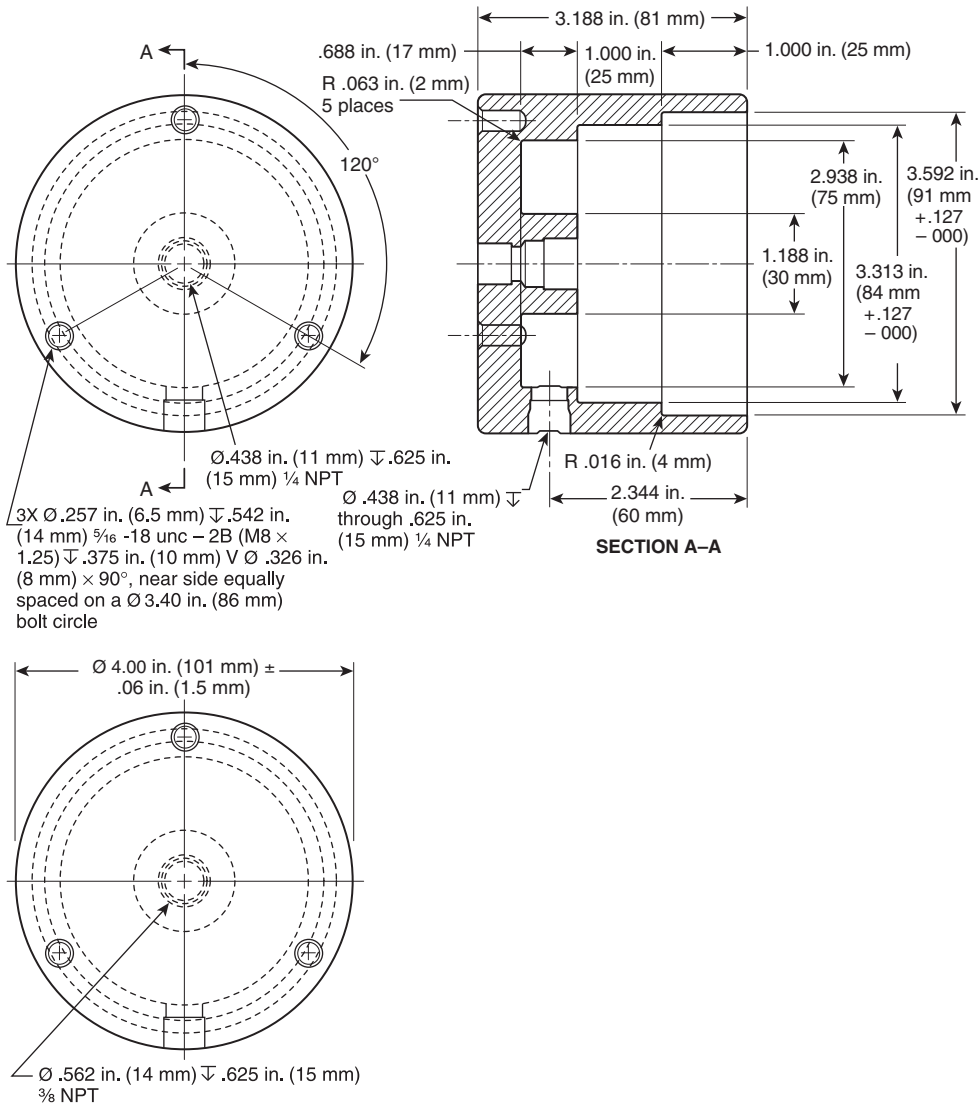

FIGURE B.19(d) Base, Detail.

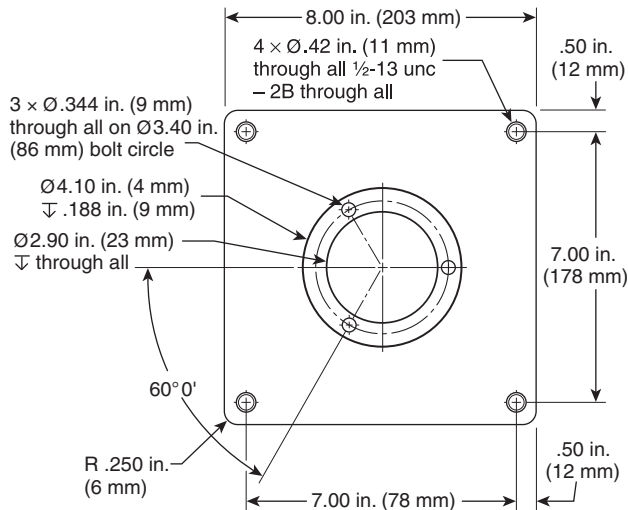

FIGURE B.19(e) Base Support Plate, $\frac{3}{8}$ in. (10 mm) Thick.

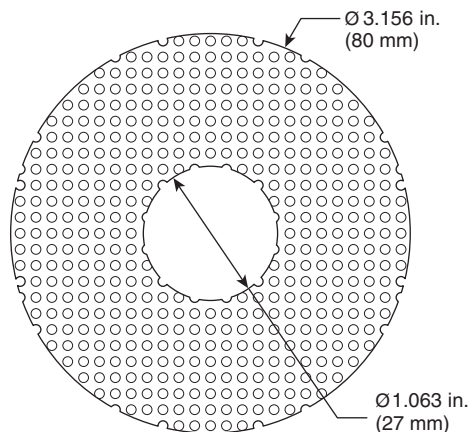

FIGURE B.19(f) Diffuser Bead Support Screen. (Material: 304 SS).

Annex C Enclosure Integrity Procedure

This annex is not a part of the requirements of this NFPA document but is included for informational purposes only.

C.1 Procedure Fundamentals. Table C.1 shows the various symbols, quantities, and units related to the enclosure integrity procedure.

C.1.1 Scope.

C.1.1.1 This procedure outlines a method to equate enclosure leakage as determined by a door fan test procedure to worst-case clean agent leakage. The calculation method provided makes it possible to predict the time it will take for a descending interface to fall to a given height or, for the continually mixed cases, the time for the concentration to fall to a given percentage concentration.

C.1.1.2 Enclosure integrity testing is not intended to verify other aspects of clean agent system reliability, that is, hardware operability, agent mixing, hydraulic calculations, and piping integrity.

C.1.1.3 This procedure is limited to door fan technology and is not intended to preclude alternative technology such as acoustic sensors.

C.1.1.4 This procedure should not be considered to be an exact model of a discharge test. The complexity of this procedure should not obscure the fact that most failures of the enclosure are due to leaks in the lower surfaces of the enclosure, but the door fan does not differentiate between upper and lower leaks. The door fan provides a worst-case leakage estimate that is very useful for enclosures with complex hidden leaks, but it will generally require more sealing than is necessary to pass a discharge test.

C.1.2 Limitations and Assumptions.

C.1.2.1 Clean Agent System Enclosure. The following should be considered regarding the clean agent system and the enclosure:

- (1) *Clean Agent System Design.* This test procedure concerns only total flooding fire suppression systems using clean agent that are designed, installed, and maintained in accordance with this standard.
- (2) *Enclosure Construction.* Clean agent protected enclosures, absent of any containing barriers above the false ceiling, are not within the scope of Annex C.
- (3) *Enclosure Height, H_0 .* This method is valid for any height enclosure, and no special considerations are needed.
- (4) *Bias Pressure.* Whenever possible, bias pressure differentials at the time of the door fan test (P_{bt}) and during the hold time (P_{bh}) (due to HVAC system, elevator connections, etc.) across the enclosure envelope should be minimized. The test can be relied on only for enclosures having the range of bias pressures outlined in C.2.6.2.3 and C.2.7.1.2(6).

▲ Table C.1 Symbols, Quantities, and Units

Symbol	Quantity	Unit
C_i	Initial concentration of extinguishant in air for the enclosure at the beginning of the hold time	vol %
C_{\min}	Calculated minimum concentration of extinguishant in air at height H in the enclosure at the end of the hold time; not less than 85 percent of the adjusted minimum design concentration	vol %
$EqLA$	Calculated equivalent leakage area (see Equation C.2.8.2)	m^2
F	Calculated lower leakage fraction, equivalent leakage area of lower leaks divided by equivalent leakage area of all leaks (see Equations C.2.8.1.2 and C.2.8.1.3)	—
g_n	Acceleration due to gravity, typically 9.81 m/s^2	m/s^2
H	Minimum protected height, which is the highest level of combustibles	m
H_0	Maximum flooded height, which is the measured enclosure height	m
k_1	Calculated leakage constant of the room, where, $Q = k_1 \cdot P^n$ (see Equation C.2.7.3.3b)	$m^3/(s \cdot Pa^n)$
k_{1l}	Calculated leakage constant for lower leaks	$m^3/(s \cdot Pa^n)$
k_{1t}	Calculated leakage constant for total leaks	$m^3/(s \cdot Pa^n)$
k_2	Calculated intermediate variable (see Equation C.2.8.1.1)	$kg^n \cdot m^{3(1-n)}/s \cdot Pa^n$
k_3	Calculated simplifying constant (see Equation C.2.8.1.5.1a)	m/s^2
k_4	Calculated simplifying constant (see Equation C.2.8.1.5.1b)	$Pa \cdot m^3/kg$
n	Calculated leakage exponent, where $Q = k_1 \cdot P^n$ (see Equation C.2.7.3.3a)	—
nl	Calculated leakage exponent for lower leaks	—
nt	Calculated flow exponent for total leaks	—
P_1	Calculated pressure for the primary test point, usually 10 Pa (see Equation C.2.7.3.2a)	Pa
P_2	Calculated pressure for the secondary test point, usually 50 Pa (see Equation C.2.7.3.2b)	Pa
P_{1d}	Measured test pressure for the primary test point in the depressurization direction	Pa
P_{2d}	Measured test pressure for the secondary test point in the depressurization direction	Pa
P_{1p}	Measured test pressure for the primary test point in the pressurization direction	Pa
P_{2p}	Measured test pressure for the secondary test point in the pressurization direction	Pa
P_{bh}	Measured or estimated bias pressure during the hold time	Pa
P_{bt}	Measured bias pressure at the time of the fan test	Pa
P_{mi}	Calculated initial agent-air mixture column pressure (see Equation C.2.7.1.4)	Pa
P_{mf}	Reference pressure difference for equivalent leakage area	Pa
Q_1	Calculated average flow at P_{1d} and P_{1p} (see Equation C.2.7.3.2c)	m^3/s
Q_2	Calculated average flow at P_{2d} and P_{2p}	m^3/s
Q_{1d}	Measured flow at P_{1d}	m^3/s
Q_{2d}	Measured flow at P_{2d}	m^3/s
Q_{1p}	Measured flow at P_{1p}	m^3/s
Q_{2p}	Measured flow at P_{2p}	m^3/s
t	Calculated hold time (see Equations C.2.8.1.5.1c, C.2.8.1.5.2, and C.2.8.1.5.3)	s
V	Maximum intentionally flooded enclosure volume	m^3
ρ_a	Air density at 21°C and 1.013 bar atmospheric pressure, 1.202 kg/m^3	kg/m^3
ρ_e	Agent vapor density at 21°C and 1.013 bar atmospheric pressure	kg/m^3
ρ_m	Density of agent-air mixture	kg/m^3
ρ_{mf}	Calculated agent-air mixture density at 21°C and 1.013 bar atmospheric pressure at C_{\min}	kg/m^3
ρ_{mi}	Calculated agent-air mixture density at 21°C and 1.013 bar atmospheric pressure at C_i (see Equation C.2.7.1.3)	kg/m^3

C.1.2.2 Door Fan Measurements. The following should be considered regarding the door fan and its associated measurements:

- (1) *Door Fan Standards.* Guidance regarding fan pressurization apparatus design, maintenance, and operation is provided by ASTM E779, ASTM E1827, and CAN/CGSB-149.10-M86.
- (2) *Attached Volumes.* There can be no significant attached volumes within or adjoining the enclosure envelope allowing detrimental clean agent leakage that would not be measured by the door fan. Such an attached volume would be significant if it is absent of any leakage except into the design envelope and is large enough to adversely affect the design concentration.
- (3) *Return Path.* All significant leaks must have an unrestricted return path to the door fan.
- (4) *Leak Location.* The difficulty in determining the specific leak location on the enclosure envelope boundaries using the door fan is accounted for by assuming clean agent leakage occurs through leaks at the worst location. This is when one-half of the total equivalent leakage area is assumed to be at the maximum enclosure height and the other half is at the lowest point in the enclosure. In cases where the below-false ceiling leakage area (BCLA) is measured using C.2.7.2, the value attained for BCLA is assumed to exist entirely at the lowest point in the enclosure.
- (5) *Technical Judgment.* Enclosures with large overhead leaks but no significant leaks in the floor slab and walls will yield unrealistically short retention time predictions. Experience has shown that enclosures of this type can be capable of retaining clean agent for prolonged periods. However, in such cases the authority having jurisdiction might waive the quantitative results in favor of a detailed witnessed leak inspection of all floors and walls with a door fan and smoke pencil.

C.1.2.3 Retention Calculations. The information in C.1.2.3.1 through C.1.2.3.8 should be considered regarding the retention calculations and the associated theory.

C.1.2.3.1 Dynamic Discharge Pressures. Losses due to the dynamic discharge pressures resulting from system actuation are not specifically addressed.

C.1.2.3.2 Bias Pressure. Variable external bias pressure differences (wind, etc.) are additive and should be considered.

C.1.2.3.3 Floor Area. The floor area is assumed to be the volume divided by the maximum height of the protected enclosure.

C.1.2.3.4 Leak Flow Characteristics. All leak flow is one dimensional and does not take into account stream functions.

C.1.2.3.5 Leak Flow Direction. A particular leak area does not have bidirectional flow at any point in time. Flow through a leak area is either into or out of the enclosure.

C.1.2.3.6 Leak Discharge. The outflow from the leak discharges into an infinitely large space.

C.1.2.3.7 Leak Locations. Calculations are based on worst-case clean agent leak locations.

C.1.2.3.8 Clean Agent Delivery. The calculations assume that the design concentration of clean agent will be achieved. If a suspended ceiling exists, it is assumed that the clean agent

discharge will not result in displacement of the ceiling tiles. Increased confidence can be obtained if ceiling tiles are clipped within 4 ft (1.2 m) of the nozzles and all perimeter tiles.

C.1.3 Definitions. For the purposes of Annex C, the following definitions are to apply.

- △ **C.1.3.1 Area, Effective Floor.** The volume divided by the maximum clean agent protected height.
- △ **C.1.3.2 Area, Effective Flow.** The area that results in the same flow as the existing system of flow areas when it is subjected to the same pressure difference over the total system of flow paths.
- △ **C.1.3.3 Area, Equivalent Leakage (EqLA).** The total combined area of all leaks, cracks, joints, and porous surfaces that act as leakage paths through the enclosure envelope. This is represented as the theoretical area of a sharp-edged orifice that would exist if the flow into or out of the entire enclosure at a given pressure were to pass solely through it.
- △ **C.1.3.4 Area, Return Path.** The effective flow area that the air being moved by the door fan must travel through to complete a return path back to the leak.
- △ **C.1.3.5 Attached Volumes.** A space within or adjoining the enclosure envelope that is not protected by clean agent and cannot be provided with a clearly defined return path.
- △ **C.1.3.6 Bias Pressure Difference.** The pressure differential across the enclosure envelope not caused by the discharge process or by the weight of the clean agent. A positive static pressure difference indicates that the pressure inside the enclosure is greater than outside the enclosure, that is, smoke would leave the enclosure at the enclosure boundary.
- △ **C.1.3.7 Ceiling Slab.** The boundary of the enclosure envelope at the highest elevation.
- △ **C.1.3.8 Column Pressure.** The theoretical maximum positive pressure created at the floor slab by the column of the clean agent-air mixture.
- △ **C.1.3.9 Descending Interface.** The enclosure integrity procedure assumes a sharp interface. When clean agent is discharged, a uniform mixture occurs. As leakage takes place, air enters the room. This procedure assumes that the incoming air rides on top of the remaining mixture. In reality, the interface usually spreads because of diffusion and convection. These effects are not modeled because of their complexity. Where a wide interface is present, the descending interface is assumed to be the midpoint of a wide interface zone. Because of the conservatism built into the procedure, the effects of interface spreading can be ignored. If continual mechanical mixing occurs, a descending interface might not be formed.
- △ **C.1.3.10 Door Fan.** The device used to pressurize or depressurize an enclosure envelope to determine its leakage characteristics. Also called the *fan pressurization apparatus*.
- △ **C.1.3.11 Enclosure.** The volume being tested by the door fan. This includes the clean agent protected enclosure and any attached volumes.
- △ **C.1.3.12 Enclosure Envelope.** The floor, walls, ceiling, and roof that together constitute the enclosure.
- △ **C.1.3.13 Enclosure, Protected (V).** The volume flooded by the clean agent extinguishing system.

△ **C.1.3.14 Fan.** The component of the door fan used to move air.

△ **C.1.3.15 Fan Pressurization Apparatus.** See *C.1.3.10, Door Fan.*

△ **C.1.3.16 Flooded Height, Maximum (H_0).** The design height of the clean agent column at the end of the discharge from the floor slab to the highest intentionally flooded point in the enclosure. This does not include the height of unprotected ceiling spaces.

△ **C.1.3.17 Floor Slab.** The boundary of the enclosure envelope at the lowest elevation.

△ **C.1.3.18 Pressure Gauge, Flow.** The component of the door fan used to measure the pressure difference across the fan to give a value used in calculating the flow into or out of the enclosure envelope.

△ **C.1.3.19 Pressure Gauge, Room.** The component of the door fan used to measure the pressure differential across the enclosure envelope.

△ **C.1.3.20 Protected Height, Minimum (H).** The minimum acceptable height from the floor slab to which the descending interface is allowed to fall during the retention time, as specified by the authority having jurisdiction.

△ **C.1.3.21 Return Path.** The path outside the enclosure envelope that allows air to travel to/from the leak to/from the door fan.

C.2 Test Procedure.

C.2.1 Preliminary Preparations. The individual(s) responsible for the protected enclosure should be contacted and the following preliminary steps should be taken:

- (1) Provide a description of the test.
- (2) Advise the responsible individuals on time required for the test.
- (3) Determine the staff needed (to control traffic flow, set HVAC, etc.).
- (4) Determine the equipment required (e.g., ladders).
- (5) Obtain a description of the HVAC system.
- (6) Establish the existence of a false ceiling space and the size of ceiling tiles.
- (7) Visually determine the readiness of the room with respect to the completion of obvious sealing.
- (8) Determine if conflict with other building trades will occur.
- (9) Determine the size of doorways.
- (10) Determine the existence of adequate return path area outside the enclosure envelope used to accept or supply the door fan air.
- (11) Evaluate other conflicting activities in and around space (e.g., interruption to the facility being tested).
- (12) Obtain appropriate architectural HVAC and system design documents.

C.2.2 Equipment Required. The equipment listed in C.2.2.1 and C.2.2.2 is required to test an enclosure using fan pressurization technology.

C.2.2.1 Door Fan System.

C.2.2.1.1 The door fan(s) should have a total air flow capacity capable of producing a pressure difference at least equal to the predicted column pressure or 10 Pa, whichever is greater.

C.2.2.1.2 The fan should have a variable speed control or a control damper in series with the fan.

C.2.2.1.3 The fan should be calibrated in air flow units or be connected to an air flow metering system.

C.2.2.1.4 The accuracy of air flow measurement should be ± 5 percent of the measured flow rate.

C.2.2.1.5 The room pressure gauge should be capable of measuring pressure differences from 0 Pa to at least 50 Pa. It should have an accuracy of ± 1 Pa and divisions of 1 Pa or less. Inclined oil-filled manometers are considered to be traceable to a primary standard and need not be calibrated. All other pressure-measurement apparatus (e.g., electronic transducer or magnehelic) should be calibrated at least yearly.

C.2.2.1.6 Door fan systems should be checked for calibration every 5 years under controlled conditions, and a certificate should be available for inspection at all integrity tests. The calibration should be performed according to manufacturer's specifications.

The certificate should include the following:

- (1) Description of calibration facility and responsible technician
- (2) Date of calibration and serial number of door fan
- (3) Room pressure gauge error estimates at 10 Pa, 15 Pa, 20 Pa, and 50 Pa measured by both ascending and descending pressures (minimum)
- (4) Fan calibration at a minimum of three leakage areas (approximate): 5.4 ft², 2.7 ft², and 0.54 ft² (0.5 m², 0.25 m², and 0.05 m²) measured at a pressure of 10 Pa

C.2.2.1.7 A second fan or multiple fans with flex duct and panel to flow to above-ceiling spaces is optional.

C.2.2.2 Accessories. The following equipment is also useful:

- (1) Smoke pencil, fully charged
CAUTION: Use of chemically generated smoke as a means of leak detection can result in activation of building or clean agent system smoke detectors. Appropriate precautions should be taken. Due to the corrosive nature of the smoke, it should be used sparingly.
- (2) Bright light source
- (3) Floor tile lifter
- (4) Measuring tape
- (5) Masking or duct tape
- (6) Test forms
- (7) Multitip screwdrivers
- (8) Shop knife or utility knife
- (9) Several sheets of thin plastic and cardboard
- (10) Door stops
- (11) Signs to post on doors that say "DO NOT SHUT DOOR — FAN TEST IN PROGRESS" or "DO NOT OPEN DOOR — FAN TEST IN PROGRESS"

C.2.3 Field Calibration Check.

C.2.3.1 This procedure enables the authority having jurisdiction to obtain an indication of the door fan and system calibration accuracy upon request.

C.2.3.2 The field calibration check should be done in a separate enclosure. Seal off any HVAC registers and grilles if present. Install the door fan per manufacturer's instructions and C.2.5. Determine if a bias pressure exists using C.2.6.2. Check openings across the enclosure envelope for air flow with

chemical smoke. If any appreciable flow or pressure exists, choose another room or eliminate the source.

C.2.3.3 Install a piece of rigid material less than $\frac{1}{8}$ in. (3 mm) thickness (free of any penetrations) in an unused fan port or other convenient enclosure opening large enough to accept an approximately 155 in.² (0.1 m²) sharp-edged round or square opening.

C.2.3.4 Ensure that the door fan flow measurement system is turned to properly measure pressurization or depressurization and operate the fan to achieve a convenient pressure differential, preferably 10 Pa.

C.2.3.5 At the pressure achieved, measure the flow and calculate an initial EqLA value using C.2.7.3. Repeat the EqLA measurement under positive pressure, then average the two results.

C.2.3.6 Create a sharp-edged round or square opening in the rigid material. The area of this opening should be at least 33 percent of the initial EqLA measured. Typical opening sizes are approximately 77.5 in.², 155 in.², and 310 in.² (0.05 m², 0.1 m², and 0.2 m²), depending on the initial leakage of the enclosure. Adjust the fan to the previously used positive or negative pressure differential. Measure the flows, then calculate an average EqLA value using C.2.8.2.

C.2.3.7 Field calibration is acceptable if the difference between the first and second EqLA value is within +15 percent of the hole area cut in the rigid material. If the difference in EqLA values is greater than +15 percent, the door fan apparatus should be recalibrated according to the manufacturer's recommendations and to ASTM E779, ASTM E1258, or CAN/CGSB-149.10-M86.

C.2.4 Initial Enclosure Evaluation.

C.2.4.1 Inspection.

C.2.4.1.1 Note the areas outside the enclosure envelope that will be used to supply or accept the door fan air.

C.2.4.1.2 Inspect all openable doors, hatches, and movable partitions for their ability to remain shut during the test.

C.2.4.1.3 Obtain or generate a sketch of the floor plan showing walls, doorways, and the rooms connected to the test space. Number or name each doorway.

C.2.4.1.4 Look for large attached volumes open to the test space via the floor or walls of the test space. Note volumes and apparent open connecting areas.

C.2.4.1.5 Check floor drains and sink drains for traps with liquid.

C.2.4.2 Measurement of Enclosure.

C.2.4.2.1 Measure the clean agent protected enclosure volume. Record all dimensions. Deduct the volume of large solid objects to obtain the net volume.

C.2.4.2.2 Measure the maximum flooded height.

C.2.4.2.3 Calculate the effective floor area by dividing the net clean agent protected volume by the maximum clean agent protected enclosure height.

C.2.4.3 Preparation.

C.2.4.3.1 Advise supervisory personnel in the area about the details of the test.

C.2.4.3.2 Remove papers and objects likely to be affected by the air currents from the discharge of the door fan.

C.2.4.3.3 Secure all doorways and openings as for a clean agent discharge. Post personnel to ensure the doorways and openings stay shut/open. Open doorways inside the protected enclosure even though they could be closed upon discharge.

C.2.4.3.4 Get the user's personnel and/or the clean agent contractor to set up the room in the same state as when a discharge would occur, that is, HVAC shut down, dampers closed, and so forth. Confirm that all dampers and closable openings are in the discharge-mode position.

C.2.5 Door Fan Installation.

C.2.5.1 The door fan apparatus generally consists of a single door fan. A double or multiple door fan for larger spaces or for neutralizing leakage through a suspended ceiling can be used for certain applications.

C.2.5.2 Set up one fan unit in the most convenient doorway leading into the space, ideally the doorway that opens into the largest return path area. Consideration should be given to individuals requiring access into or out of the facility.

C.2.5.3 Follow the manufacturer's instructions regarding setup.

C.2.5.4 Before door fan installation, examine the sealing around the door that the door fan will be mounted in to determine if significant leakage exists. If significant leaks are found, they should be corrected. If the manufacturer's stated door fan sealing system leakage is less than the apparent remaining leakage of the doorway, the difference must be added to the leakage calculated.

C.2.5.5 Ensure that all pressure gauges are leveled and zeroed prior to connecting them to the fan apparatus. Unless the gauge has an auto-zero function that is turned on, this should be done by first gently blowing into or drawing from the tubes leading to the pressure gauges so the needle, fluid, or readout moves through its entire span and stays at the maximum gauge reading for 10 seconds. This confirms proper gauge operation. If a magnehelic gauge is being used, gently tap the gauge face for 10 seconds. With both ports of each gauge on the same side of the doorway (using tubes if necessary), zero the gauges with their particular adjusting method.

C.2.5.6 Connect the tubing for the room pressure gauge. Ensure the tube is at the floor slab elevation and extends at least 10 ft (3 m) away from the outlet side of the door fan, away from its air stream path, and away from all significant air streams (i.e., HVAC air flows or openings where air flow could impinge on the tube).

C.2.5.7 The door fan should be arranged to alternately blow out of (depressurize) and blow into (pressurize) the space. Both measurements should be taken as described in C.2.8.

C.2.6 Door Fan Enclosure Evaluation.

C.2.6.1 Pressure Run-up Inspection.

C.2.6.1.1 Activate the fan and adjust the enclosure pressure to +15 Pa so that smoke used for air current detection moves out of the enclosure.

C.2.6.1.2 Inspect all dampers with smoke to ensure they are closing properly. Record problems and notify individuals responsible for the enclosure of the problems.

C.2.6.1.3 Inspect doors and hatches to ensure correct closure. Record problems and notify individuals responsible for the enclosure of the problems.

C.2.6.1.4 Inspect the wall perimeter (above and below the false floor) and the floor slab for major leaks. Note location and size of major leaks. Track down major air flow currents.

C.2.6.2 Bias Pressure Measurement.

C.2.6.2.1 Bias pressures are the background pressures that exist in the enclosure when the fan is stopped and sealed. Bias pressure must be measured or estimated for two different conditions. The first condition (which can always be measured) is the bias pressure present during the actual enclosure integrity test (P_{bi}). The second condition (which may need to be estimated) is the bias pressure expected after discharge, during the hold time (P_{bh}). To measure bias pressure, seal the fan opening with the door fan properly installed but without the fan operating. Observe the room pressure gauge for at least 30 seconds. Look for minor fluctuations in pressure. Determine the flow direction with smoke or other indicating method.

C.2.6.2.2 With the room set up as it would be under hold time conditions, measure the bias pressure P_{bh} across a section of envelope containing the largest quantity of leaks expected to leak clean agent. If the subfloor is pressurized during the hold time, measure the differential between the subfloor and outside the envelope. If the room cannot be set up as would be under discharge conditions, P_{bh} will need to be estimated.

C.2.6.2.3 With the room set up for the room integrity test, measure the bias pressure P_{bi} . If P_{bi} has an absolute value greater than 25 percent of the column pressure calculated in C.2.7.1.4, it must be permanently reduced. Large bias pressures decrease the level of certainty inherent in this procedure. The most common causes of excessive bias pressure are leaky dampers, ducts, and failure to shut down air-handling equipment serving the enclosure.

C.2.6.2.4 Record the position of all doorways, whether open or shut, when the bias pressure P_{bh} is measured.

C.2.7 Door Fan Measurement.

C.2.7.1 Total Enclosure Leakage Method.

C.2.7.1.1 This method determines the leakage of the entire enclosure envelope. It is determined by measuring the enclosure leakage under both positive and negative pressures and averaging the absolute values of the readings. This approach is used to minimize the influence of bias pressures on the leakage calculation.

C.2.7.1.2 The procedures for determining the leakage of the entire enclosure envelope are as follows:

- (1) Prop open all doorways around the enclosure and post personnel to ensure they stay open.
- (2) Ensure that adequate return path area is provided to allow an unrestricted return air flow path back to the door fan from enclosure leaks.
- (3) Remove 1 percent of the floor tiles (for false floors) if an equivalent area is not already open.

- (4) If agent is designed to discharge above the false ceiling, remove 1 percent of the ceiling tiles.
- (5) Remeasure the bias pressure at the time of the door fan test (P_{bi}) between the room (not below the false floor) and the return path space.
- (6) Make every effort to reduce P_{bi} by shutting down air-handling equipment even though it can operate during discharge. P_{bi} must be within a range of ± 5 Pa.
- (7) Record P_{bi} and determine its direction using smoke or other means.
- (8) Record the position of each doorway, open/shut.
- (9) If the bias pressure fluctuates due to wind, use a wind-damping system incorporating four averaging tubes on each side of the building or electronic averaging to eliminate its effects. CAN/CGSB-149.10-M86 can be used.
- (10) If a subfloor pressurization air handler cannot be shut down for the test and leaks exist in the subfloor, those leaks cannot be accurately measured. Every attempt should be made to reduce subfloor leaks to insignificance. During the test, as many floor tiles as possible should be lifted to reduce the amount of subfloor pressurization. Note that under such conditions the suspended ceiling leakage neutralization method will be difficult to conduct due to massive air turbulence in the room.
CAUTION: The removal of raised floor tiles creates a serious safety hazard. Appropriate precautions should be taken.
- (11) If relief dampers are present, they should be blocked shut so they do not open during the door fan test. (At the completion of the test, the dampers must be unblocked.)

C.2.7.1.3 Agent-Air Mixture Density. Calculate the density of the agent-air mixture (ρ_{mi}) using the following equation:

[C.2.7.1.3]

$$\rho_{mi} = \rho_e \frac{C_i}{100} + \left[\rho_a \frac{(100 - C_i)}{100} \right]$$

ρ_e values are shown in Table C.2.7.1.3.

Table C.2.7.1.3 Agent Vapor Densities at 70°F (21°C) and 14.7 psi (1.013 bar) atmospheric pressure (ρ_e)

Agent	Vapor Densities	
	lb/ft ³	kg/m ³
FK-5-1-12	0.865	13.86
HCFC Blend A	0.240	3.85
HCFC 124	0.363	5.81
HFC-125	0.313	5.02
HFC-227ea	0.453	7.26
HFC-23	0.183	2.92
HFC-236fa	0.407	6.52
FIC-1311	0.500	8.01
HFC Blend B	0.263	4.22
IG-01	0.104	1.66
IG-100	0.072	1.16
IG-541	0.088	1.41
IG-55	0.088	1.41

C.2.7.1.4 Calculate the initial column pressure caused by the clean agent air-mixture in the protected enclosure using the following equation:

[C.2.7.1.4]

$$P_{mi} = (g_n)(H_0)(\rho_{mi} - \rho_a)$$

C.2.7.1.5 Depressurize the enclosure with a door fan until the measured pressure differential reading on the gauge is -10 Pa. If using analog gauges, tap both the room pressure gauge and the flow pressure gauge for 10 seconds each. Wait an additional 30 seconds before taking the readings. Record pressure P_{1d} .

C.2.7.1.6 Measure the air flow Q_{1d} in cubic meters per second required to obtain P_{1d} .

C.2.7.1.7 Repeat C.2.7.1.5 and C.2.7.1.6 at a pressure of -50 Pa (or higher), record P_{2d} , then measure the flow (Q_{2d}). To reduce extrapolation errors, the ratio of P_{2d} to P_{1d} must be 5:1 or more.

If the door fan is not capable of achieving a test pressure, P_2 , of 50 Pa, then the test can be performed at 10 Pa only. In this case, the exponent, n , must be set at 0.5 and can result in much more conservative retention times and venting areas.

C.2.7.1.8 Repeat the procedure in C.2.7.1.5 through C.2.7.1.7 while pressurizing the enclosure to $+10$ Pa (P_{1p}) and $+50$ Pa (P_{2p}) and measure the air flows. Each pressure must be within 5 percent of the corresponding depressurization pressure.

C.2.7.1.9 Ensure that the door fan flow measurement system is actually turned around between tests to properly measure pressurization or depressurization and that the motor rotation is not simply reversed. Ensure that the air flow entering the room is not deflected upward, which can cause lifting of any existing ceiling tiles.

C.2.7.2 Suspended Ceiling Leakage Neutralization Method (Optional).

C.2.7.2.1 Where an unobstructed suspended ceiling exists, the leakage area below the ceiling can optionally be measured by neutralizing ceiling leaks. This method provides a more accurate estimate of retention time. This method should not be used if the walls between rooms within the zone are sealed at the ceiling slab. This method cannot be used when the system is designed to protect the area above the suspended ceiling. This test method does not imply that leakage above the suspended ceiling is acceptable. This technique can be difficult or impossible to perform under the following conditions:

- (1) Air movement within the room could make it difficult to observe neutralization, particularly in small rooms.
- (2) Obstructions above the suspended ceiling, that is, beams, ducts, and partitions, could make it difficult to obtain uniform neutralization.
- (3) Limited clearance above the suspended ceiling, for example, less than 1 ft (0.3 m), could make it difficult to obtain neutralization.

C.2.7.2.2 If not already done, obtain the leakage of the protected enclosure using the total enclosure leakage method in C.2.7.1.

C.2.7.2.3 Ceiling level supply registers and return grilles can be temporarily sealed off to increase the accuracy of this method. If such openings are sealed, P_{bt} should be re-measured.

Temporary sealing of such openings is not permitted when a total enclosure leakage test is being conducted.

C.2.7.2.4 Install two separate door fans or a multiple fan system with one fan ducted to the space above suspended ceiling and the other ducted into the room space below the suspended ceiling. It is not necessary to measure air flow through the upper fan.

C.2.7.2.5 Depressurize above and below the suspended ceiling by adjusting two separate fans until the required pressure reduction and the suspended-ceiling leak neutralization (i.e., no air flow through the suspended ceiling) are achieved.

Leaks are neutralized when, at opened locations in the suspended ceiling, smoke does not move up or down when emitted within $\frac{1}{4}$ in. (6 mm) of the openings. If neutralization is not possible at all locations, ensure that smoke either does not move or moves down but not up. Choose undisturbed locations away from flex duct flows, air streams, and lighting fixtures, because local air velocities make neutralization difficult to detect.

C.2.7.2.6 Measure the air flow (Q_{1d} and Q_{2d}) through the fan that is depressurizing the volume below the false ceiling to obtain the pressure (P_{1d} and P_{2d}).

C.2.7.2.7 Repeat the procedure in C.2.7.2.5 and C.2.7.2.6 while pressurizing the enclosure, except ensure that smoke either does not move or moves up but not down.

C.2.7.2.8 An alternative method for measuring the below-ceiling leaks consists of temporarily sealing identifiable ceiling-level leaks using a flexible membrane, such as polyethylene sheet and tape, and then measuring the below-ceiling leakage solely using door fans drawing from the lower part of the room. No flex duct is needed. Examples of sealable leaks are undamped ceiling-level supply registers or return grilles or an entire suspended ceiling lower surface.

C.2.7.3 Leakage Calculation.

C.2.7.3.1 This subsection outlines the door fan calculation to be used in conjunction with C.2.7.1 and C.2.7.2.

C.2.7.3.2 Correct the recorded pressures for bias pressure during the test (P_{bt}) and then average the magnitude of each pressure measurement to get the average pressures P_1 and P_2 using Equations C.2.7.3.2a and C.2.7.3.2b. Average the flows at each pressure measurement to get the average flows Q_1 and Q_2 using Equations C.2.7.3.2c and C.2.7.3.2d.

[C.2.7.3.2a]

$$P_1 = \frac{(|P_{1p} - P_{bt}| + |P_{1d} - P_{bt}|)}{2}$$

[C.2.7.3.2b]

$$P_2 = \frac{(|P_{2p} - P_{bt}| + |P_{2d} - P_{bt}|)}{2}$$

$$Q_1 = \frac{(Q_{1p} + Q_{1d})}{2}$$

[C.2.7.3.2c]

$$Q_2 = \frac{(Q_{2p} + Q_{2d})}{2}$$

[C.2.7.3.2d]

C.2.7.3.3 Calculate the flow exponent n and the flow constant k_1 using the following equations:

$$n = \frac{\ln(Q_1/Q_2)}{\ln(P_1/P_2)}$$

[C.2.7.3.3a]

$$k_1 = \frac{Q_1}{(P_1)^n}$$

[C.2.7.3.3b]

$$Q = k_1 \cdot (P)^n$$

[C.2.7.3.3c]

n is typically in the range of 0.48 to 0.85.

C.2.7.3.4 Equations C.2.7.3.2a through C.2.7.3.2d, C.2.7.3.3a, and C.2.7.3.3b should be used for both the total enclosure leakage method (see C.2.7.1) and the optional suspended ceiling leakage neutralization method (see C.2.7.2).

C.2.8 Retention Calculation.

C.2.8.1 Calculation.

C.2.8.1.1 Calculate the intermediate calculation variable k_2 using the following equation:

$$k_2 = k_1 \left(\frac{\rho_a}{2} \right)^n$$

[C.2.8.1.1]

C.2.8.1.2 Leak Fraction for Total Leakage Method. If the leakage is measured using only C.2.7.1, the worst-case leakage distribution must be assumed and the following lower leak fraction should be used:

$$F = 0.5$$

[C.2.8.1.2]

C.2.8.1.3 Leak Fraction for Lower Leakage Method. If a lower leaks test is performed and the lower leakage is measured, then the lower leak fraction (F) is determined using the following equation:

$$F = \frac{k_{1L}}{k_{1T}} 10^{(nL-nT)}$$

[C.2.8.1.3]

For extinguishants lighter than air, $F = 0.5$.

C.2.8.1.4 Minimum Height. Determine from the authority having jurisdiction the minimum height from the floor slab (H) that is not to be affected by the descending interface during the holding period.

C.2.8.1.5 Time. For extinguishants that are heavier than air, determine if a descending interface will form during the hold time or if continual mixing will occur. If a descending interface will form, use Equations C.2.8.1.5.1a through C.2.8.1.5.1c to calculate the minimum time (t) that the enclosure is expected to maintain the descending interface above (H). If continual mixing is expected to occur, use Equation C.2.8.1.5.2 to determine the time (t) it will take for the concentration to drop from C_i to C_{\min} . In all cases, if the extinguishant density is lighter than air, then continual mixing is assumed to occur, and Equation C.2.8.1.5.3 should be used to calculate the retention time.

C.2.8.1.5.1 Calculation for Extinguishants That Are Heavier Than Air with a Descending Interface. Calculate the simplifying constant k_3 using this equation:

$$k_3 = \frac{2g_n |\rho_m - \rho_a|}{\rho_m + \rho_a \left(\frac{F}{1-F} \right)^{1/n}}$$

[C.2.8.1.5.1a]

Calculate the simplifying constant k_4 using this equation:

$$k_4 = \frac{2|P_{bh}|}{\rho_m + \rho_a \left(\frac{F}{1-F} \right)^{1/n}}$$

[C.2.8.1.5.1b]

$$t = \frac{V}{H_0} \left(\frac{(k_3 H_0 + k_4)^{1-n} - (k_3 H + k_4)^{1-n}}{(1-n) k_2 F k_3} \right)$$

[C.2.8.1.5.1c]

C.2.8.1.5.2 Calculation for Extinguishants That Are Heavier Than Air with Continual Mixing.

[C.2.8.1.5.2]

$$t = \frac{V}{Fk_2} \int_{\rho_a}^{\rho_m} \left(\frac{2g_n H_0 |\rho_m - \rho_a|^{(n+1)/n} + 2P_{at} |\rho_m - \rho_a|^{1/n}}{\rho_m + \rho_a \left(\frac{F}{1-F} \right)^{1/n}} \right)^{-n} d\rho_m$$

C.2.8.1.5.3 Calculation for Extinguishants That Are Lighter Than Air.

[C.2.8.1.5.3]

$$t = \frac{V}{Fk_2} \int_{\rho_m}^{\rho_a} \left(\frac{2g_n H_0 |\rho_m - \rho_a|^{(n+1)/n} + 2P_{at} |\rho_m - \rho_a|^{1/n}}{\rho_m + \rho_a \left(\frac{F}{1-F} \right)^{1/n}} \right)^{-n} d\rho_m$$

Calculate ρ_{mf} using Equation C.2.7.1.4 and substituting C_{min} for C_i .

C.2.8.2 Leakage area for visualization or relief vent calculation is found by the following equation:

[C.2.8.2]

$$EqLA = 1.271 \cdot P_{ref}^{(n-0.5)} \cdot k_1$$

This leakage area is commonly referred to as the equivalent leakage area (EqLA) and is equivalent to the area of a hole in a thin flat plate with a discharge coefficient of 0.61 at the pressure of interest, P_{ref} .

C.2.8.3 Acceptance Criteria. The time (t) that was calculated in C.2.7.1.5 must equal or exceed the holding time period specified by the authority having jurisdiction.

C.2.9 Leakage Control.

C.2.9.1 Leakage Identification.

C.2.9.1.1 While the enclosure envelope is being pressurized or depressurized, a smoke pencil or other smoke source should be used to locate and identify leaks.

The smoke should not be produced by an open flame or any other source that is a potential source of fire ignition. Chemical smoke should be used only in small quantities, and consideration should be given to the corrosive nature of certain chemical smokes and their effects on the facility being tested.

C.2.9.1.2 Leakage identification should focus on obvious points of leakage, including wall to floor slab joint, wall to ceiling slab joint, penetrations of all kinds, HVAC ductwork, doors, and windows.

C.2.9.1.3 Alternative methods for leakage identification are available and should be considered. One method is the use of a directional acoustic sensor that can be selectively aimed at different sound sources. Highly sensitive acoustic sensors are available that can detect air as it flows through an opening. Openings can be effectively detected by placing an acoustic source on the other side of the barrier and searching for acoustic transmission independent of fan pressurization or depressu-

riziation. Another alternative is to use an infrared scanning device if temperature differences across the boundary are sufficient.

C.2.9.2 Leakage Alteration.

C.2.9.2.1 Procedure.

C.2.9.2.1.1 Protected areas should be enclosed with wall partitions that extend from the floor slab to the ceiling slab or from the floor slab to the roof.

C.2.9.2.1.2 If a raised floor continues out of the protected area into adjoining rooms, partitions should be installed under the floor directly under above-floor border partitions. These partitions should be caulked top and bottom. If the adjoining rooms share the same under-floor air handlers, then the partitions should have dampers installed in the same manner as is required for ductwork.

C.2.9.2.1.3 Any holes, cracks, or penetrations leading into or out of the protected area should be sealed, including pipe chases and wire troughs. All walls should be caulked around the inside perimeter of the room where the walls rest on the floor slab and where the walls intersect with the ceiling slab or roof above.

C.2.9.2.1.4 Porous block walls should be sealed slab-to-slab to prevent gas from passing through the block. Multiple coats of paint could be required.

C.2.9.2.1.5 All doors should have door sweeps or drop seals on the bottoms and weather stripping around the jambs, latching mechanisms, and door closer hardware. In addition, double doors should have a weather-stripped astragal to prevent leakage between doors and a coordinator to ensure proper sequence of closure.

C.2.9.2.1.6 Windows should have solid weather stripping around all joints.

C.2.9.2.1.7 All unused and out-of-service ductwork leading into or from a protected area should be permanently sealed off (airtight) with metal plates caulked and screwed in place. Ductwork still in service with the building air-handling unit should have butterfly blade-type dampers installed with neoprene seals. Dampers should be spring-loaded or motor-operated to provide 100 percent air shutoff. Alterations to air conditioning, heating, ventilating ductwork, and related equipment should be in accordance with NFPA 90A or NFPA 90B, as applicable.

C.2.9.2.1.8 All floor drains should have traps, and the traps should be designed to have water or other compatible liquid in them at all times.

C.2.9.2.2 Materials.

C.2.9.2.2.1 All materials used in altering leaks on enclosure envelope boundaries, including walls, floors, partitions, finish, acoustical treatment, raised floors, suspended ceilings, and other construction, should have a flame spread rating that is compatible with the flame spread requirements of the enclosure.

C.2.9.2.2.2 Exposed cellular plastics should not be used for altering leakage unless considered acceptable by the authority having jurisdiction.

C.2.9.2.2.3 Cable openings or other penetrations into the enclosure envelope should be firestopped with material that is compatible with the fire rating of the barrier.

C.2.10 Test Report. Upon completion of a door fan test, a written test report should be prepared for the authority having jurisdiction and made part of the permanent record. The test report should include the following:

- (1) Date, time, and location of the test
- (2) Names of witnesses to the test
- (3) Room dimensions and volume
- (4) All data generated during the test, including computer printouts
- (5) Descriptions of any special techniques utilized by the testing technician (e.g., use of optional ceiling neutralization and temporary sealing of suspended ceiling)
- (6) In case of technical judgment, a full explanation and documentation of the judgment
- (7) Test equipment make, model, and serial number
- (8) Copy of current calibration certificate of test equipment
- (9) Name and affiliation of the testing technician and signature

Annex D Enclosure Evaluation

This annex is not a part of the requirements of this NFPA document but is included for informational purposes only.

D.1 The discharge of a clean agent total flooding fire extinguishing system into a protected enclosure creates pressure fluctuations therein. Normally, for halocarbon agents, the enclosure will have enough vent area and resistive strength to moderate and resist the pressure changes so that no damage occurs. In some circumstances, however, the enclosure could be damaged by the momentary pressure change. Damaging pressure can develop if there is insufficient vent area provided by normal leakage in the enclosure boundary. Alternatively, enclosure damage might occur due to a relatively weak construction, perhaps because of design or fabrication deficiencies. Damage could occur due to a combination of these factors.

The peak pressure created in an enclosure depends on many factors, including the agent concentration and discharge time, humidity, opening characteristics of the system discharge valve, and the aggregate vent area of the enclosure. The most influential parameter is the aggregate vent area, which comprises all openings, whether unintentional or intentional.

Pressures are developed within an enclosure during the discharge of both inert and halocarbon clean agents. The discharge of an inert agent results in only a positive pressure change, as illustrated by Figure D.1(a).

On the other hand, the discharge of a halocarbon agent usually creates an initially negative pressure change followed by a positive pressure change, as illustrated by Figure D.1(b).

Figure D.1(b) shows the measured pressure changes within an enclosure during an actual discharge of halocarbon clean agent. The measured pressure within the enclosure initially dropped to a negative peak value of -387 Pa (8.1 psf), then rose to the positive peak value of +671 Pa (14.0 psf) before falling back down to 0, about 10 seconds after the end of the 5.5 second discharge.

Enclosures must be capable of withstanding peak pressures, whether positive in the case of the inert agents or both negative and positive in the case of the halocarbon agents. To achieve this objective, it is necessary to determine the strength of the enclosure's bounding walls, floor, and ceiling in terms of their ability to resist pressure decreases and increases as applicable to the specific agent.

The strength of the enclosure walls and ceiling usually determine the overall strength of an enclosure. The strength of the construction elements and their physical dimensions play an important role. For example, a common wall construction system consists of gypsum wallboard attached to vertical studs of either metal or wood. The inherent strength of the stud system will dictate the overall strength of the wall. The stud material, physical dimensions, and spacing between studs have a significant influence on the overall strength of the stud system.

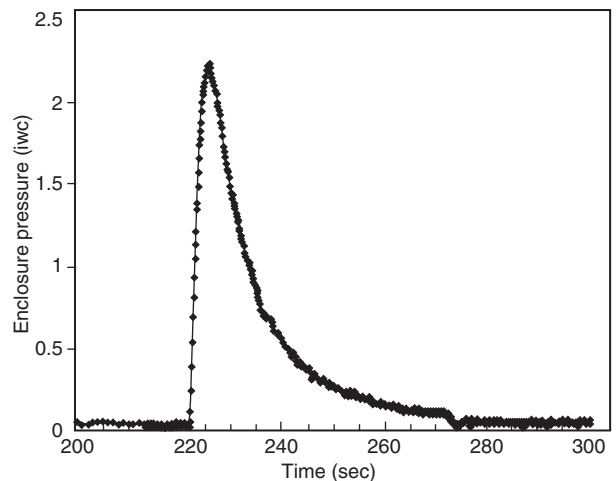

FIGURE D.1(a) Example of an Actual IG-541 60-Second Discharge Showing Peak Pressure.

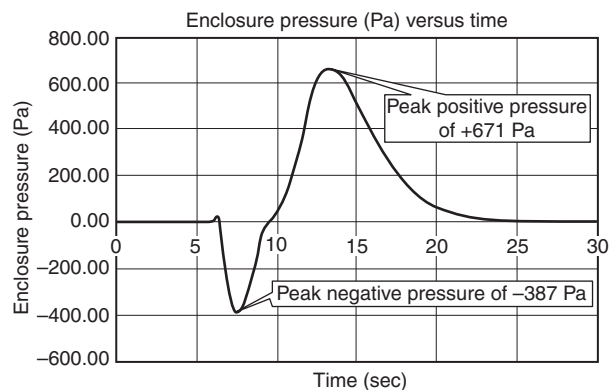

FIGURE D.1(b) Example of an Actual HFC-227ea Discharge Showing Peak Pressures.

Annex E Informational References

E.1 Referenced Publications. The documents or portions thereof listed in this annex are referenced within the informational sections of this standard and are not part of the requirements of this document unless also listed in Chapter 2 for other reasons.

E.1.1 NFPA Publications. National Fire Protection Association, 1 Batterymarch Park, Quincy, MA 02169-7471.

NFPA 12A, *Standard on Halon 1301 Fire Extinguishing Systems*, 2018 edition.

NFPA 70®, *National Electrical Code®*, 2017 edition.

NFPA 72®, *National Fire Alarm and Signaling Code®*, 2016 edition.

NFPA 75, *Standard for the Fire Protection of Information Technology Equipment*, 2017 edition.

NFPA 77, *Recommended Practice on Static Electricity*, 2014 edition.

NFPA 90A, *Standard for the Installation of Air-Conditioning and Ventilating Systems*, 2018 edition.

NFPA 90B, *Standard for the Installation of Warm Air Heating and Air-Conditioning Systems*, 2018 edition.

E.1.2 Other Publications.

E.1.2.1 ACGIH Publications. American Conference of Governmental Industrial Hygienists, 1330 Kemper Meadow Drive, Cincinnati, OH 45240.

2016 TLVs and BEIs (*Threshold Limit Values and Biological Exposure Indices*), 2016.

E.1.2.2 AIHA Publications. American Industrial Hygiene Association, 3141 Fairview Park Drive, Suite 777, Falls Church, VA 22042.

ERPG/WEEL Handbook, 2016.

E.1.2.3 ASHRAE Publications. ASHRAE, Inc., 1791 Tullie Circle, N.E., Atlanta, GA 30329-2305.

ANSI/ASHRAE 34, *Designation and Safety Classification of Refrigerants*, 2013.

E.1.2.4 ASME Publications. American Society of Mechanical Engineers, Two Park Avenue, New York, NY 10016-5990.

ASME B31.1, *Power Piping Code*, 2016.

E.1.2.5 ASTM Publications. ASTM International, 100 Barr Harbor Drive, P.O. Box C700, West Conshohocken, PA 19428-2959.

ASTM E176, *Standard Terminology of Fire Standards*, 2015.

ASTM E177, *Standard Practice for Use of the Terms Precision and Bias in ASTM Test Methods*, 2014.

ASTM E456, *Standard Terminology Relating to Quality and Statistics*, 2013.

ASTM E691, *Standard Practice for Conducting an Interlaboratory Study to Determine the Precision of a Test Method*, 2016.

ASTM E779, *Standard Test Method for Determining Air Leakage Rate by Fan Pressurization*, 2010.

ASTM E1258, *Standard Test Method for Airflow Calibration of Fan Pressurization Devices*, 1988 (2012).

ASTM E1354, *Standard Test Method for Heat and Visible Smoke Release Rates for Materials and Products Using an Oxygen Consumption Calorimeter*, 2016.

ASTM E1827, *Standard Test Methods for Determining Airtightness of Buildings Using an Orifice Blower Door*, 2011.

ASTM F1387, *Standard Specification for Performance of Piping and Tubing Mechanically Attached Fittings*, 1999 (2012).

E.1.2.6 CGA Publications. Compressed Gas Association, 14501 George Carter Way, Suite 103, Chantilly, VA 20151-2923.

CGA C-6, *Standard for Visual Inspection of Steel Compressed Gas Cylinders*, 2013.

E.1.2.7 CSA Group Publications. CSA Group, 178 Rexdale Blvd., Toronto, ON M9W 1R3, Canada.

CAN/CGSB-149.10-M86, *Determination of the Airtightness of Building Envelopes by the Fan Depressurization Method*, 1986.

E.1.2.8 FSSA Publications. Fire Suppression Systems Association, 3601 E. Joppa Road, Baltimore, MD 21234. www.fssa.net

FSSA Application Guide to Estimating Enclosure Pressure Relief Vent Area for Use with Clean Agent Fire Extinguishing Systems, 2nd edition, revision 1, January 2013.

FSSA Design Guide for Use with Fire Protection Systems Inspection Forms, January 2012.

FSSA Pipe Design Handbook for Use with Special Hazard Fire Suppression Systems, 2nd edition, 2011.

FSSA Test Guide for Use with Special Hazard Fire Suppression Systems Containers, 3rd edition, January 2012.

FSSA Application Guide Detection & Control for Fire Suppression Systems, November 2010.

E.1.2.9 HARC Publications. Halon Alternatives Research Corporation, 1001 19th Street North, Suite 1200, Arlington, VA 22209. www.harc.org

HARC Code of Practice for Use of Recycled Halogenated Clean Agents, 2015.

E.1.2.10 IMO Publications. International Maritime Organization, 4, Albert Embankment, London, SE1 7SR United Kingdom.

International Convention for the Safety of Life at Sea (SOLAS), 1974. (Including all amendments through 2011).

IMO MSC/Circ. 776, "Guidelines for the Approval of Equivalent Fixed Gas Fire-Extinguishing Systems," as referred to in SOLAS 74 for Machinery Spaces and Cargo Pump-Rooms, 12 Dec 1996.

E.1.2.11 ISO Publications. International Organization for Standardization, ISO Central Secretariat, BIBC II, Chemin de Blandonnet 8, CP 401, 1214 Vernier, Geneva, Switzerland.

ISO 14520-1, *Gaseous fire-extinguishing systems — Physical properties and system design — Part 1: General requirements*, 2015.

NE.1.2.12 MSS Publications. Manufacturer's Standardization Society (MSS) of the Valve and Fittings Industry, 127 Park St. NE, Vienna, VA 22180-4602.

ANSI/MSS SP-58, *Pipe Hangers and Supports — Materials, Design, Manufacture, Selection, Application, and Installation*, 2009.

MSS SP-127, *Bracing for Piping Systems: Seismic — Wind — Dynamic Design, Selection, and Application*, 2014a.

NE.1.2.13 SFPE Publications. Society of Fire Protection Engineers, 9711 Washingtonian Blvd., Suite 380, Gaithersburg, MD 20878.

Hurley, Morgan (editors), *SFPE Handbook of Fire Protection Engineering*, fifth edition, 2015.

E.1.2.14 UL Publications. Underwriters Laboratories Inc., 333 Pfingsten Road, Northbrook, IL 60062-2096.

ANSI/UL 2127, *Standard for Inert Gas Clean Agent Extinguishing System Units*, 2012 (revised 2015).

ANSI/UL 2166, *Standard for Halocarbon Clean Agent Extinguishing System Units*, 2012 (revised 2015).

E.1.2.15 U.S. Government Publications. U.S. Government Publishing Office, 732 North Capitol Street, NW, Washington, DC 20401-0001.

DOT, Title 49, Code of Federal Regulations.

U.S. Coast Guard, Title 46, Code of Federal Regulations, Part 111.59, Subchapter J.

▲ E.1.3 Other References.

Back, G. G., C. L. Beyler, P. J. DiNenno, M. Peatross, "Draft Report: Full-Scale Machinery Space Testing of Gaseous Halon Alternatives," USCG R&D Center, Groton, CT, 1994.

Brockway, J. C., "Recent Findings on Thermal Decomposition Products of Clean Extinguishing Agents," 3M Report presented at NFPA 2001 Committee Meeting, Ft. Lauderdale, FL, Sept. 19–22, 1994.

Cholin, R. R., "Testing the Performance of Halon 1301 on Real Computer Installations," *Fire Journal*, September 1972.

Coll, J. P., "Inerting Characteristics of Halon 1301 and 1211 Using Various Combustibles," Fenwal CRC Report No. PSR-661, August 16, 1976.

Cotton, F. A., and G. Wilkinson, *Advanced Inorganic Chemistry*, p. 364, John Wiley & Sons, New York, 1980.

Dalby, W., Evaluation of the toxicity of hydrogen fluoride at short exposure times. Stonybrook Laboratories, Inc., 311 Pennington-Rocky Hill Road, Pennington, NJ, sponsored by the Petroleum Environmental Research Forum (PERF), PERF Project No. 92–90, 1996.

Dalzell, W. G., "A Determination of the Flammability Envelope of Four Ternary Fuel-Air-Halon 1301 Systems," Fenwal CRC Report No. PSR-624, October 7, 1975.

Dierdorf, D. S., T. A. Moore, S. R. Skaggs, "Decomposition Product Analysis During Intermediate-Scale (645 ft³) and Laboratory-Scale (6.18 ft³) Testing of NFPA 2001 Agents," University of New Mexico, Albuquerque, NM, 1993.

DiNenno, P. J., "Engineering Evaluation and Comparison of Halon Alternatives and Replacements," International CFC & Halon Alternatives Conference, Washington, DC, 1993.

DiNenno, P. J., et al., "Modeling of the Flow Properties and Discharge of Halon Replacement Agents," *Process Safety Progress*, Vol. 14, No. 1, January 1995.

Dumayas, W. A., "Effect of HF Exposure on PC Multifunction Cards," Senior Research Project, Department of Fire Protection Engineering, University of Maryland, College Park, MD, 1992.

DuPont Company, "Acute inhalation of hydrogen fluoride in rats," Haskell Laboratory Report HLR, pp. 365–90, 1990.

Elliot, D. G., et al., "Flow of Nitrogen-Pressurized Halon 1301 in Fire Extinguishing Systems," *JPL Publication 84-62*, Jet Propulsion Laboratory, Pasadena, CA, November 1984.

Fernandez, R., "DuPont's Alternatives to Halon 1301 and 1211, Recent Findings," *Proceedings*, Halon Technical Working Conference, April 30–May 1, 1991, Albuquerque, NM.

Ford, C. L., *Halon 1301 Computer Fire Test Program: Interim Report*, 1972.

Forssell, E., and P. J. DiNenno, *Hazard Assessment of Thermal Decomposition Products of FM-200™ in Electronics and Data Processing Facilities*, Hughes Associates, 1995.

Forssell, et al., "Draft Report: Performance of FM-200 on Typical Class A Computer Room Fuel Packages," Hughes Associates, Inc., Columbia, MD, October 1994.

Grosshandler, W. L. (editor), *Nuisance Alarms in Aircraft Cargo Areas and Critical Telecommunications Systems: Proceedings of the Third NIST Fire Detector Workshop*, NISTIR 6146, National Institute of Standards and Technology, Gaithersburg, MD, March 1998.

HT Research Institute, 1973.

Hanauska, C., "Perfluorocarbons as Halon Replacement Candidates," *Proceedings*, Halon Technical Working Conference, April 30–May 1, 1991, Albuquerque, NM.

Handbook of Chemistry and Physics, 83rd ed., D. R. Lide (editor), Ch. 14, p. 19, "U.S. Standard Atmosphere (1976)," CRC Press LLC, 2002.

Hesson, J. C., "Pressure Drop for Two Phase Carbon Dioxide Flowing in Pipe Lines," Master of Science Thesis in CH.E. Illinois Institute of Technology, January 1953.

Hughes Associates, Inc., *Hazard Assessment of Thermal Decomposition Products of FM-200™ in Electronics and Data Processing Facilities*, 1995.

Largent, E. J., The metabolism of fluorides in man. *Arch Ind. Health* 21:318–323, 1960.

Linteris, G. T., *Suppression of Cup-Burner Flames by Super-Effective Chemical Inhibitors and Inert Compounds Proceedings*, Halon Options Technical Working Conference, pp. 187–196. Albuquerque, NM, April 24–26, 2001.

Machle, W., and K. R. Kitzmiller, The effects of the inhalation of hydrogen fluoride. II. The response following exposure to low concentrations. *J. Ind. Hyg. Toxicol.* 17:223–229, 1935.

- Machle, W., F. Tharnann, K. R. Kitzmiller, and J. Cholak, The effects of the inhalation of hydrogen fluoride. I. The response following exposure to high concentrations. *J. Ind. Hyg. Toxicol.* 16:129–45, 1934.
- Meacham, B. J., *Fire Technology*, First Quarter, p. 35, 1993.
- Meldrum, M., *Toxicology of Substances in Relation to Major Hazards: Hydrogen Fluoride*, Health and Safety Executive (HSE) Information Centre, Sheffield S37HQ, England, 1993.
- Moore, T. A., D. S. Dierdorf, and S. R. Skaggs, “Intermediate-Scale (645 ft³) Fire Suppression Evaluation of NFPA 2001 Agents,” Halons Options Technical Working Conference, Albuquerque, NM, 1993.
- Naval Research Laboratory Report Ser 6180/0049.2, “Agent Concentration Inhomogeneities in Real Scale Halon Replacement,” 26 January 1995.
- Peatross, M. J., and E. W. Forssell, “A Comparison of Thermal Decomposition Product Testing of Halon 1301 Alternative Agents,” Halon Options Technical Working Conference, Albuquerque, NM, 1996.
- Pedley, M. D., *Corrosion of Typical Orbiter Electronic Components Exposed to Halon 1301 Pyrolysis Products*, NASA TR-339-001, 1995.
- Preece, S., P. Mackay, and A. Chatlaway, *The Cup Burner Method — A Parametric Analysis of the Factors Influencing the Reported Extinguishing Concentrations of Inert Gases*, *Proceedings*, Halon Options Technical Working Conference, April 24–26, Albuquerque, NM, 2001.
- Purser, D. A., “The Performance of Fire Retarded Materials in Relation to Toxicity, Toxic Hazard and Toxic Risk,” Society of Chemical Industry Fire Chemistry Discussion Group, University of Lancaster, UK, 1998.
- Robin, M. L., “Evaluation of Halon Alternatives,” p. 16, *Proceedings*, Halon Technical Working Conference, April 30–May 1, 1991, Albuquerque, NM.
- Sax, N. I., *Dangerous Properties of Industrial Materials*, 6th edition, Van Nostrand Reinhold, New York, 1984.
- Schmeer, Justin S., “Methane and Propane Inerting Concentrations of FK-5-1-12,” Memorandum to Paul E. Rivers, 3M Performance Materials Division, June 13, 2003.
- Senecal, J. A., Agent Inerting Concentrations for Fuel-Air Systems, Fenwal Safety Systems CRC Technical Note No. 361, May 27, 1992.
- Senecal, J. A., “Flame Extinguishing by Inert Gases: Theoretical & Experimental Analysis,” Central States Section/The Combustion Institute Meeting, March 2004.
- Senecal, J. A., “Flame Extinguishing in the Cup-Burner by Inert Gases,” *Fire Safety Journal*, Vol. 40, Issue 6, pp. 579–591, September 2005.
- Senecal, J. A., “Standardizing the Measurement of Minimum Extinguishing Concentrations of Gaseous Agents,” *Fire Technology*, Vol. 44, No. 3, pp. 207–220, September 2008.
- Sheinson, R. S., et al., *J. Fire & Flamm.*, 12, 229, 1981.
- Sheinson, R. S., “Halon Alternatives — Compartment Total Flooding Testing,” *Proceedings*, International Conference on CFC and Halon Alternatives, p. 629, December 3–5, 1991, Baltimore, MD, 1991.
- Sheinson, R. S., et al., “Halon 1301 Total Flooding Fire Testing, Intermediate Scale,” *Proceedings*, Halon Alternatives Technical Working Conference, May 3–5, 1994, Albuquerque, NM.
- Sheinson, R. S., et al., “Large Scale (840 m³) Total Flooding Fire Extinguishment Results,” *Proceedings*, Halon Alternatives Technical Working Conference, May 1995, Albuquerque, NM.
- Skaggs, S. R., and T. Moore, *Toxicological Properties of Halon Replacements*, 208th ACS National Meeting, Washington, DC, 1994.
- Skaggs, S. R., and T. Moore, *Toxicology of Halogenated Halon Substitutes*, Fire Safety Without Halon Conference, Zurich, Switzerland, September 1994.
- Takahashi, F., G. T. Linteris, and V. R. Katta, *Suppression of Cup-Burner Flames*, Fourth International Symposium on Scale Modeling (ISSM-IV). Cleveland, OH, September 17–19, 2003.
- Tamanini, F., “Determination of Inerting Requirements for Methane/Air and Propane/Air Mixtures by an Ansul Inerting Mixture of Argon, Carbon Dioxide and Nitrogen,” Factory Mutual Research, August 24, 1992.
- Wysocki, T. J., “Single Point Flow Calculations for Liquefied Compressed Gas Fire Extinguishing Agents,” *Proceedings*, Halon Options Technical Working Conference Proceedings, Albuquerque, NM, 1996.
- Wysocki, T. J., and B. C. Christensen, “Inert Gas Fire Suppression Systems Using IG541 (Inergen) Solving the Hydraulic Calculation Problem,” *Proceedings*, Halon Options Technical Working Conference, Albuquerque, NM, 1996.
- Zabetakis, Michael G., “Flammability Characteristics of Combustible Gases and Vapors,” Bulletin 627, U.S. Department of the Interior, Bureau of Mines, 1965.

E.2 Informational References. The following documents or portions thereof are listed here as informational resources only. They are not a part of the requirements of this document.

E.2.1 ASTM Publications. ASTM International, 100 Barr Harbor Drive, PO Box C700, West Conshohocken, PA, 19428-2959.

ASTM A53/A53M, *Standard Specification for Pipe, Steel, Black and Hot-Dipped, Zinc-Coated Welded and Seamless*, 2012.

ASTM D6064, *Standard Specification for HFC-227ea, 1,1,1,2,3,3,3-Heptafluoropropane (CF₃CHF₂CF₃)*, 2015.

ASTM D6126, *Standard Specification for HFC-23 (Trifluoromethane, CHF₃)*, 2015.

ASTM D6231, *Standard Specification for HFC-125 (Pentafluoroethane, C₂HF₅)*, 2015.

ASTM D6541, *Standard Specification for HFC-236fa, 1,1,1,3,3,3-Hexafluoropropane, (CF₃CH₂CF₃)*, 2015.

ASTM D7327, *Standard Specification for HFC Blend B (CH₂FCF₃, CHF₂CF₃, and CO₂)*, 2017.

N E.2.2 FM Global Publications. FM Global, 270 Central Avenue, P.O. Box 7500, Johnston, RI 02919.

FM Approvals 5600, *Approval Standard for Clean Agent Extinguishing Systems*, 2013.

Δ E.2.3 Other Publications.

Bayless, H., and R. Niemann, "Update on the Evaluation of Selected NFPA 2001 Agents for Suppressing Class 'C' Energized Fires, Proceedings, Halon Options Technical Working Conference, Albuquerque, NM, 1998, pp. 293–294.

Bengtson, G., et al., "Update on the Evaluation of Selected NFPA 2001 Agents for Suppressing Class C Energized Fires Featuring C6 F-Ketone," Halon Options Technical Working Conference, April 30–May 2, 2002, Albuquerque, NM.

Bengtson, G., and R. Niemann, "Update on the Evaluation of Selected NFPA 2001 Agents for Suppressing Class C Energized Fires," Proceedings, Halon Options Technical Working Conference, Albuquerque, NM, May 24–26, 2005.

Braun, E., et al., "Determination of Suppression Concentration for Clean Agents Exposed to a Continuously Energized Heated Metal Surface," May 6–9, 1997, 1997 Halon Options Technical Working Conference, Albuquerque, NM.

DiNenno, P. J., and E. K. Budnick, "A Review of Discharge Testing of Halon 1301 Total Flooding Systems," National Fire Protection Research Foundation, Quincy, MA, 1988.

DiNenno, P. J., and E. W. Forsell, et al., "Evaluation of Halon 1301 Test Gas Simulants," *Fire Technology*, 25 (1), 1989.

DiNenno, P. J., and E. W. Forsell, et al., "Hydraulic Performance Tests of Halon 1301 Test Gas Simulants," *Fire Technology*, 26 (2), pp. 121–140, May 1990.

Driscoll, M., and P. Rivers, "Clean Extinguishing Agents and Continuously Energized Circuits," NIST Conference, Gaithersburg, MD, October 1996.

Driscoll, M., and P. Rivers, "Clean Extinguishing Agents and Continuously Energized Circuits: Recent Findings," Halon Options Technical Working Conference, Albuquerque, NM, May 6–8, 1997.

EPA, *Inventory of U.S. Greenhouse Gas Emissions and Sinks: 1990–2007, 2009. Federal Register*, Vol. 59, Page 13044, "EPA SNAP Program."

Fellows, B. R., R. G. Richard, and I. R. Shankland, "Electrical Characterization of Alternative Refrigerants," XVIII International Congress of Refrigeration, August 10–17, 1991.

Ferreira, M. J., C. P. Hanauska, and M. T. Pike, "Thermal Decomposition Products Results Utilizing PFC-410 (3M Brand PFC 410 Clean Extinguishing Agent)," Halon Alternatives Working Conference, Albuquerque, NM, May 12–14, 1992.

Ferreira, M. J., J. A. Pignato, and M. T. Pike, "An Update on Thermal Decomposition Product Results Utilizing PFC-410," International CFC and Halon Alternative Conference, Washington, DC, October 1, 1992.

Flamm, J., et al., "Continuing the Examination and Comparison of Existing Halon Alternatives in Preventing Reignition on Continuously Energized Fires," *Proceedings*, Halon Options Technical Working Conference, Albuquerque, NM, 2005.

Hirt, C. W., and N. C. Romero, "Application of a Drift-Flux Model to Flashing in Straight Pipes," Los Alamos Scientific Laboratory, Los Alamos, NM, 1976.

Kelly, A., and P. Rivers, Clean Agents Concentration Requirements for Continuously Energized Fires, NIST Conference, Gaithersburg, MD, August 1997.

Lambertsen, C. J., "Research Bases for Improvements of Human Tolerance to Hypoxic Atmospheres in Fire Prevention and Extinguishment," Institute for Environmental Medicine, University of Pennsylvania, October 30, 1992.

Lambertsen, C. J., "Short Duration Inergen Exposures, Relative to Cardiovascular or Pulmonary Abnormality," Institute for Environmental Medicine, University of Pennsylvania, February 1, 1993.

McKenna, L.A., et al., "Extinguishment Tests of Continuously Energized Class C Fires," Halon Options Technical Working Conference, Albuquerque, NM, May 12–14, 1998.

Nicholas, J. S., and S. W. Hansen, "Summary of the Physiology of Inergen," Ansul Fire Protection, April 1, 1993.

Niemann, R., H. Bayless, and C. Craft, "Evaluation of Selected NFPA 2001 Agents for Suppressing Class 'C' Energized Fires," *Proceedings*, pp. 399–412, Halon Options Technical Working Conference, Albuquerque, NM, 1996.

Niemann, R., and H. Bayless, "Update on the Evaluation of Selected NFPA 2001 Agents for Suppressing Class C Energized Fires," Halon Options Technical Working Conference, Albuquerque, NM, May 12–14, 1998.

Robin, M. L., "Halon Alternatives: Recent Technical Progress," Halon Alternatives Working Conference, Albuquerque, NM, May 12–14, 1992.

Skaggs, S. R., R. E. Tapscott, and T. A. Moore, "Technical Assessment for the SNAP Program," Halon Alternatives Working Conference, Albuquerque, NM, May 12–14, 1992.

Smith, D., and P. Rivers, "Effectiveness of Clean Agents on Burning Polymeric Materials Subjected to an External Energy Source," Halon Options Technical Working Conference, Albuquerque, NM, April 27–29, 1999.

Smith, D., et al., "Energized Fire Performance of Clean Agents: Recent Developments," November 1997.

Smith, D. M., et al., "Examination and Comparison of Existing Halon Alternatives and New Sustainable Clean Agent Technology in Suppressing Continuously Energized Fires," Halon Options Technical Working Conference, Albuquerque, NM, 2001.

Steckler, K., and W. Grosshandler, "Clean Agent Performance in Fires Exposed to an External Energy Source," November 1998.

United Nations Environment Programme, Montreal Protocol on Substances that Deplete the Ozone Layer — Final Act 1987, UNEP/RONA, Room DCZ-0803, United Nations, New York, NY, 10017.

E.3 References for Extracts in Informational Sections. (Reserved).

Index

Copyright © 2017 National Fire Protection Association. All Rights Reserved.

The copyright in this index is separate and distinct from the copyright in the document that it indexes. The licensing provisions set forth for the document are not applicable to this index. This index may not be reproduced in whole or in part by any means without the express written permission of NFPA.

-A-

Abort Switch

Definition, 3.3.1, A.3.3.1

Adjusted Minimum Design Quantity (AMDQ)

Definition, 3.3.2

Administration, Chap. 1

Compatibility with Other Agents, 1.8

Environmental Factors, 1.6, A.1.6

General Information, 1.4

Applicability of Agents, 1.4.1, A.1.4.1

Use and Limitations, 1.4.2, A.1.4.2

Purpose, 1.2

Retrofitability, 1.7

Safety, 1.5

Electrical Clearances, 1.5.2

Hazards to Personnel, 1.5.1, A.1.5.1

Halocarbon Agents, 1.5.1.2, A.1.5.1.2

Inert Gas Clean Agents, 1.5.1.3, A.1.5.1.3

Safety Requirements, 1.5.1.5

Scope, 1.1

Units, 1.3

Agent Concentration

Definition, 3.3.3

Approval of Installations, Chap. 7

Acceptance Test Report, 7.3

Functional Testing, 7.7

Control Panel Primary Power Source, 7.7.4

Preliminary Functional Tests, 7.7.1

Remote Monitoring Operations, 7.7.3

Return of System to Operational Condition, 7.7.5

System Functional Operational Test, 7.7.2

General, 7.2, A.7.2

System Acceptance Testing, 7.2.3

Owner's Documentation, 7.8

Review of Electrical Components, 7.6

Manual Pull Stations, 7.6.12

Systems Using Abort Switches, 7.6.14

Systems with Main/Reserve Capability, 7.6.13

Review of Enclosure Integrity, 7.5

Review of Mechanical Components, 7.4

Safety, 7.1, A.7.1

Training, 7.9

Approved

Definition, 3.2.1, A.3.2.1

Authority Having Jurisdiction (AHJ)

Definition, 3.2.2, A.3.2.2

-C-

Class A Fire

Definition, 3.3.4

Class B Fire

Definition, 3.3.5

Class C Fire

Definition, 3.3.6

Clean Agent

Definition, 3.3.7, A.3.3.7

Clearance

Definition, 3.3.8

Components, Chap. 4

Agent Supply, 4.1

Agent Storage Containers, 4.1.4

Storage Containers, 4.1.4.1, A.4.1.4.1

Quality, 4.1.2, A.4.1.2

Quantity, 4.1.1

Primary Agent Supply, 4.1.1.1

Reserve Agent Supply, 4.1.1.2, A.4.1.1.2

Uninterrupted Protection, 4.1.1.3

Storage Container Arrangement, 4.1.3

Detection, Actuation, Alarm, and Control Systems, 4.3

Automatic Detection, 4.3.2

Control Equipment, 4.3.4

General, 4.3.1

Operating Alarms and Indicators, 4.3.5

Time Delays, 4.3.5.6

Operating Devices, 4.3.3

Unwanted System Operation, 4.3.6, A.4.3.6

Distribution, 4.2

Discharge Nozzles, 4.2.5

Pipe, 4.2.1, A.4.2.1

Dirt Trap, 4.2.1.6

Pipe Connections, 4.2.2

Pipe Hangers and Supports, 4.2.3, A.4.2.3

Valves, 4.2.4

Control Room and Electronic Equipment Space

Definition, 3.3.9

Cup Burner Method for Determining the Minimum Concentration of Gaseous Agent for Flame Extinguishment, Annex B

Agent Concentration, B.14

Direct Gas Analysis Method, B.14.3

Continuous Sampling Analyzer, B.14.3.1

Discrete Sample Analyzer, B.14.3.2

Flow Rate Methods, B.14.2

Mass Flow Rate, B.14.2.2

Volumetric Flow Rate, B.14.2.1

General, B.14.1

Oxygen Analyzer Measurement Method, B.14.4

Statistics, B.14.5

Apparatus, B.9

Cup Burner Apparatus, B.9.1

Base Assembly, B.9.1.1

- Chimney, B.9.1.2
 - Cup, B.9.1.4
 - Body, B.9.1.4.1
 - Cup Preparation for Gaseous Fuels, B.9.1.5
 - Heating Element, B.9.1.5.1
 - Temperature Measurement, B.9.1.5.2
 - Flow Straightener, B.9.1.6
 - Fuel Supply, B.9.1.3
 - Gaseous Fuel Supply, B.9.1.3.2
 - Liquid Fuel Reservoir, B.9.1.3.1
 - Gas Flow Rates and Agent Concentration Measurement, B.9.2
 - Agent, B.9.2.2
 - Agent Concentration, B.9.2.2.3
 - Agent Flow Rate, B.9.2.2.1
 - Agent Concentration Measurement, B.9.2.2.1.3
 - Agent Flow Rate Measurement, B.9.2.2.1.2
 - Agent Flow Regulation, B.9.2.2.1.1
 - Liquid Agent, B.9.2.2.2
 - Oxygen Concentration, B.9.2.2.4
 - Air Supply, B.9.2.1
 - Air Flow Rate, B.9.2.1.1
 - Air Flow Rate Measurement, B.9.2.1.1.2
 - Air Flow Regulation, B.9.2.1.1.1
 - Humidity, B.9.2.1.2
 - Gaseous Fuel, B.9.3
 - Calibration and Standardization, B.10
 - Standardization, B.10.7
 - System Calibration, B.10.6
 - Calibration Interval, B.10.6.3
 - Primary Reference Agent, B.10.6.1
 - Second Reference Agent, B.10.6.2
 - Conditioning, B.12
 - Barometric Pressure, B.12.3
 - Fuel Temperature, B.12.2
 - Laboratory Temperature, B.12.1
 - Figures, B.19
 - Interferences, B.7
 - Air, B.7.2
 - Barometric Pressure, B.7.3
 - Deposits on Cup Rim, B.7.4
 - Fuel Character, B.7.1
 - Fuel Overflow, B.7.6
 - Humidity, B.7.5
 - Introduction, B.1
 - Notes, B.18
 - Additional Notes, B.18.2
 - Endnotes, B.18.1
 - Precision and Bias, B.16
 - Precision, B.16.1
 - Procedure, B.13
 - Gaseous Fuels, B.13.2
 - Agent Addition, B.13.2.7
 - Fuel Flow Rate and Flame Size, B.13.2.4
 - Number of Test Trials, B.13.2.9
 - Liquid Fuels, B.13.1
 - Agent Addition, B.13.1.8
 - Number of Test Trials, B.13.1.11
 - Referenced Documents, B.3
 - Safety Precautions, B.8
 - Combustion Product Ventilation, B.8.2
 - General Fire Hazard, B.8.3
 - Pressurized Equipment, B.8.1
 - Scope, B.2
 - Significance and Use, B.6
 - Summary of Test Method, B.5
 - Terminology, B.4
 - Definitions, B.4.1
 - Definitions of Terms Specific to the Cup Burner Method, B.4.2
 - Agent, B.4.2.1
 - Primary Reference Agent, B.4.2.1.1
 - Secondary Reference Agent, B.4.2.1.2
 - Study Agent, B.4.2.1.3
 - Chimney, B.4.2.2
 - Cup, B.4.2.3
 - Extinguishing Concentration, B.4.2.4
 - Extinguishment, B.4.2.5
 - Flow Straightener, B.4.2.6
 - Fuel, B.4.2.7
 - Reference Fuel, B.4.2.7.1
 - Gaseous Reference Fuel, B.4.2.7.1.1
 - Liquid Reference Fuel, B.4.2.7.1.2
 - Study Fuel, B.4.2.7.2
 - Lifted Flame, B.4.2.8
 - Minimum Extinguishing Concentration (MEC), B.4.2.9
 - Observation Period, B.4.2.10
 - Pre-Burn Time, B.4.2.11
 - Test Report, B.15
 - Test Specimens, B.11
 - Agent, B.11.3
 - Air, B.11.1
 - Fuel, B.11.2
- D-**
- Definitions**, Chap. 3
 - Design Concentration**
 - Adjusted Minimum Design Concentration (AMDC)
 - Definition, 3.3.10.1, A.3.3.10.1
 - Definition, 3.3.10
 - Final Design Concentration (FDC)
 - Definition, 3.3.10.2, A.3.3.10.2
 - Design Factor (DF)**
 - Definition, 3.3.11
- E-**
- Enclosure Evaluation**, Annex D
 - Enclosure Integrity Procedure**, Annex C
 - Procedure Fundamentals, C.1
 - Definitions, C.1.3
 - Area, Effective Floor, C.1.3.1
 - Area, Effective Flow, C.1.3.2
 - Area, Equivalent Leakage (EqLA), C.1.3.3
 - Area, Return Path, C.1.3.4

- Attached Volumes, C.1.3.5
- Bias Pressure Difference, C.1.3.6
- Ceiling Slab, C.1.3.7
- Column Pressure, C.1.3.8
- Descending Interface, C.1.3.9
- Door Fan, C.1.3.10
- Enclosure, C.1.3.11
- Enclosure Envelope, C.1.3.12
- Enclosure, Protected (V), C.1.3.13
- Fan, C.1.3.14
- Fan Pressurization Apparatus, C.1.3.15
- Flooded Height, Maximum (H₀), C.1.3.16
- Floor Slab, C.1.3.17
- Pressure Gauge, Flow, C.1.3.18
- Pressure Gauge, Room, C.1.3.19
- Protected Height, Minimum (H), C.1.3.20
- Return Path, C.1.3.21
- Limitations and Assumptions, C.1.2
 - Clean Agent System Enclosure, C.1.2.1
 - Door Fan Measurements, C.1.2.2
 - Retention Calculations, C.1.2.3
 - Bias Pressure, C.1.2.3.2
 - Clean Agent Delivery, C.1.2.3.8
 - Dynamic Discharge Pressures, C.1.2.3.1
 - Floor Area, C.1.2.3.3
 - Leak Discharge, C.1.2.3.6
 - Leak Flow Characteristics, C.1.2.3.4
 - Leak Flow Direction, C.1.2.3.5
 - Leak Locations, C.1.2.3.7
- Scope, C.1.1
- Test Procedure, C.2
 - Door Fan Enclosure Evaluation, C.2.6
 - Bias Pressure Measurement, C.2.6.2
 - Pressure Run-up Inspection, C.2.6.1
 - Door Fan Installation, C.2.5
 - Door Fan Measurement, C.2.7
 - Leakage Calculation, C.2.7.3
 - Suspended Ceiling Leakage Neutralization Method (Optional), C.2.7.2
 - Total Enclosure Leakage Method, C.2.7.1
 - Agent-Air Mixture Density, C.2.7.1.3
- Equipment Required, C.2.2
 - Accessories, C.2.2.2
 - Door Fan System, C.2.2.1
- Field Calibration Check, C.2.3
- Initial Enclosure Evaluation, C.2.4
 - Inspection, C.2.4.1
 - Measurement of Enclosure, C.2.4.2
 - Preparation, C.2.4.3
- Leakage Control, C.2.9
 - Leakage Alteration, C.2.9.2
 - Materials, C.2.9.2.2
 - Procedure, C.2.9.2.1
 - Leakage Identification, C.2.9.1
- Preliminary Preparations, C.2.1
- Retention Calculation, C.2.8
 - Acceptance Criteria, C.2.8.3
 - Calculation, C.2.8.1
 - Leak Fraction for Lower Leakage Method, C.2.8.1.3
 - Leak Fraction for Total Leakage Method, C.2.8.1.2
 - Minimum Height, C.2.8.1.4
 - Time, C.2.8.1.5
 - Calculation for Extinguishants That Are Heavier Than Air with a Descending Interface, C.2.8.1.5.1
 - Calculation for Extinguishants That Are Heavier Than Air with Continual Mixing, C.2.8.1.5.2
 - Calculation for Extinguishants That Are Lighter Than Air, C.2.8.1.5.3
 - Test Report, C.2.10
- Engineered System**
 - Definition, 3.3.12
- Explanatory Material**, Annex A
- F-**
- Fill Density**
 - Definition, 3.3.13
- Final Design Quantity (FDQ)**
 - Definition, 3.3.14
- H-**
- Halocarbon Agent**
 - Definition, 3.3.15, A.3.3.15
- I-**
- Inert Gas Agent**
 - Definition, 3.3.16
- Informational References**, Annex E
- Inspection**
 - Definition, 3.3.17
- Inspection, Servicing, Testing, Maintenance, and Training**, Chap. 8
 - Annual Inspection and Service, 8.4
 - Enclosure Inspection, 8.4.5
 - System Hoses, 8.4.4
 - Container Test, 8.6, A.8.6
 - General, 8.1
 - Fire Protection Service Technician, 8.1.2
 - Safety, 8.1.1
 - Hose Test, 8.7
 - Maintenance, 8.5, A.8.5
 - Enclosure Maintenance, 8.5.4
 - Monthly Inspection, 8.2, A.8.2
 - Semiannual Service and Inspection, 8.3
 - Training, 8.8
- L-**
- Listed**
 - Definition, 3.2.3, A.3.2.3
- Local Application System**
 - Definition, 3.3.18
- Local Application Systems**, Chap. 6
 - Clean Agent Requirements, 6.3
 - Description, 6.1
 - General Requirements, 6.1.2

Safety Requirements, 6.1.3, A.6.1.3	-N-
Uses, 6.1.1	
Hazard Specifications, 6.2	No Observed Adverse Effect Level (NOAEL)
Extent of Hazard, 6.2.1	Definition, 3.3.26
Location of Hazard, 6.2.2	Normally Occupied Enclosure or Space
Location and Number of Nozzles, 6.5	Definition, 3.3.27, A.3.3.27
Nozzles, 6.4	-O-
Discharge Time, 6.4.3	Occupiable Enclosure or Space
Nozzle Discharge Rates, 6.4.2	Definition, 3.3.28
Nozzle Selection, 6.4.1	
Operation, 6.6, A.6.6	-P-
Lockout Valve	Pre-Engineered System
Definition, 3.3.19	Definition, 3.3.29
Lowest Observable Adverse Effect Level (LOAEL)	Pump Room
Definition, 3.3.20	Definition, 3.3.30
-M-	-R-
Machinery Space	Recovered Agent
Definition, 3.3.21	Definition, 3.3.31
Maintenance	Recycled Agent
Definition, 3.3.22	Definition, 3.3.32
Marine Systems	Referenced Publications , Chap. 2
Definition, 3.3.23	
Marine Systems , Chap. 9	-S-
Additional Requirements for Systems Protecting Class B Hazards Greater Than 6000 ft ³ (170 m ³) with Stored Cylinders Within the Protected Space, 9.6	Safety Factor (SF)
Agent Supply, 9.4	Definition, 3.3.33
Approval of Installations, 9.12	Sea Level Equivalent of Agent
Compliance, 9.14	Definition, 3.3.34
Design Concentration Requirements, 9.8	Sea Level Equivalent of Oxygen
Combinations of Fuels, 9.8.1	Definition, 3.3.35
Design Concentration, 9.8.2	Service
Duration of Protection, 9.8.5, A.9.8.5	Definition, 3.3.36
Flame Extinguishment, 9.8.3	Shall
Total Flooding Quantity, 9.8.4, A.9.8.4	Definition, 3.2.4
Detection, Actuation, and Control Systems, 9.5	Should
Automatic Detection, 9.5.2	Definition, 3.2.5
General, 9.5.1	Standard
Distribution System, 9.9	Definition, 3.2.6
Discharge Time, 9.9.2	Superpressurization
Rate of Application, 9.9.1	Definition, 3.3.37
Enclosure, 9.7	System Design , Chap. 5
General, 9.1	Design Concentration Requirements, 5.4
Scope, 9.1.1	Flame Extinguishment, 5.4.2
Hazards to Personnel, 9.3	Inerting, 5.4.3, A.5.4.3
Inspection and Tests, 9.11	Distribution System, 5.7
Nozzle Choice and Location, 9.10	Extended Discharge, 5.7.2, A.5.7.2
Periodic Puff Testing, 9.13	Rate of Application, 5.7.1
Use and Limitations, 9.2	Discharge Time, 5.7.1.1, A.5.7.1.1
Minimum Design Quantity (MDQ)	Duration of Protection, 5.6, A.5.6
Definition, 3.3.24	Enclosure, 5.3, A.5.3
Minimum Design Temperature	Nozzle Choice and Location, 5.8
Definition, 3.3.25	Specifications, Plans, and Approvals, 5.1
	Approval of Plans, 5.1.3
	Specifications, 5.1.1
	Working Plans, 5.1.2
	Flow Calculations, 5.1.2.5
	System Flow Calculations, 5.2, A.5.2

Total Flooding Quantity, 5.5		-T-
Design Factors, 5.5.3, A.5.5.3		
Additional Design Factors, 5.5.3.2, A.5.5.3.2		
Design Factor for Enclosure Pressure, 5.5.3.3, A.5.5.3.3		
Tee Design Factor, 5.5.3.1, A.5.5.3.1		
	Total Flooding	
	Definition, 3.3.38	
	Total Flooding System	
	Definition, 3.3.39	

Sequence of Events for the Standards Development Process

Once the current edition is published, a Standard is opened for Public Input.

Step 1 – Input Stage

- Input accepted from the public or other committees for consideration to develop the First Draft
- Technical Committee holds First Draft Meeting to revise Standard (23 weeks); Technical Committee(s) with Correlating Committee (10 weeks)
- Technical Committee ballots on First Draft (12 weeks); Technical Committee(s) with Correlating Committee (11 weeks)
- Correlating Committee First Draft Meeting (9 weeks)
- Correlating Committee ballots on First Draft (5 weeks)
- First Draft Report posted on the document information page

Step 2 – Comment Stage

- Public Comments accepted on First Draft (10 weeks) following posting of First Draft Report
- If Standard does not receive Public Comments and the Technical Committee chooses not to hold a Second Draft meeting, the Standard becomes a Consent Standard and is sent directly to the Standards Council for issuance (see Step 4) or
- Technical Committee holds Second Draft Meeting (21 weeks); Technical Committee(s) with Correlating Committee (7 weeks)
- Technical Committee ballots on Second Draft (11 weeks); Technical Committee(s) with Correlating Committee (10 weeks)
- Correlating Committee Second Draft Meeting (9 weeks)
- Correlating Committee ballots on Second Draft (8 weeks)
- Second Draft Report posted on the document information page

Step 3 – NFPA Technical Meeting

- Notice of Intent to Make a Motion (NITMAM) accepted (5 weeks) following the posting of Second Draft Report
- NITMAMs are reviewed and valid motions are certified by the Motions Committee for presentation at the NFPA Technical Meeting
- NFPA membership meets each June at the NFPA Technical Meeting to act on Standards with “Certified Amending Motions” (certified NITMAMs)
- Committee(s) vote on any successful amendments to the Technical Committee Reports made by the NFPA membership at the NFPA Technical Meeting

Step 4 – Council Appeals and Issuance of Standard

- Notification of intent to file an appeal to the Standards Council on Technical Meeting action must be filed within 20 days of the NFPA Technical Meeting
- Standards Council decides, based on all evidence, whether to issue the standard or to take other action

Notes:

1. Time periods are approximate; refer to published schedules for actual dates.
2. Annual revision cycle documents with certified amending motions take approximately 101 weeks to complete.
3. Fall revision cycle documents receiving certified amending motions take approximately 141 weeks to complete.

Committee Membership Classifications^{1,2,3,4}

The following classifications apply to Committee members and represent their principal interest in the activity of the Committee.

1. M *Manufacturer*: A representative of a maker or marketer of a product, assembly, or system, or portion thereof, that is affected by the standard.
2. U *User*: A representative of an entity that is subject to the provisions of the standard or that voluntarily uses the standard.
3. IM *Installer/Maintainer*: A representative of an entity that is in the business of installing or maintaining a product, assembly, or system affected by the standard.
4. L *Labor*: A labor representative or employee concerned with safety in the workplace.
5. RT *Applied Research/Testing Laboratory*: A representative of an independent testing laboratory or independent applied research organization that promulgates and/or enforces standards.
6. E *Enforcing Authority*: A representative of an agency or an organization that promulgates and/or enforces standards.
7. I *Insurance*: A representative of an insurance company, broker, agent, bureau, or inspection agency.
8. C *Consumer*: A person who is or represents the ultimate purchaser of a product, system, or service affected by the standard, but who is not included in (2).
9. SE *Special Expert*: A person not representing (1) through (8) and who has special expertise in the scope of the standard or portion thereof.

NOTE 1: “Standard” connotes code, standard, recommended practice, or guide.

NOTE 2: A representative includes an employee.

NOTE 3: While these classifications will be used by the Standards Council to achieve a balance for Technical Committees, the Standards Council may determine that new classifications of member or unique interests need representation in order to foster the best possible Committee deliberations on any project. In this connection, the Standards Council may make such appointments as it deems appropriate in the public interest, such as the classification of “Utilities” in the National Electrical Code Committee.

NOTE 4: Representatives of subsidiaries of any group are generally considered to have the same classification as the parent organization.

Submitting Public Input / Public Comment Through the Online Submission System

Soon after the current edition is published, a Standard is open for Public Input.

Before accessing the Online Submission System, you must first sign in at www.nfpa.org. *Note: You will be asked to sign-in or create a free online account with NFPA before using this system:*

- a. Click on Sign In at the upper right side of the page.
- b. Under the Codes and Standards heading, click on the “List of NFPA Codes & Standards,” and then select your document from the list or use one of the search features.

OR

- a. Go directly to your specific document information page by typing the convenient shortcut link of www.nfpa.org/document# (Example: NFPA 921 would be www.nfpa.org/921). Sign in at the upper right side of the page.

To begin your Public Input, select the link “The next edition of this standard is now open for Public Input” located on the About tab, Current & Prior Editions tab, and the Next Edition tab. Alternatively, the Next Edition tab includes a link to Submit Public Input online.

At this point, the NFPA Standards Development Site will open showing details for the document you have selected. This “Document Home” page site includes an explanatory introduction, information on the current document phase and closing date, a left-hand navigation panel that includes useful links, a document Table of Contents, and icons at the top you can click for Help when using the site. The Help icons and navigation panel will be visible except when you are actually in the process of creating a Public Input.

Once the First Draft Report becomes available there is a Public Comment period during which anyone may submit a Public Comment on the First Draft. Any objections or further related changes to the content of the First Draft must be submitted at the Comment stage.

To submit a Public Comment you may access the online submission system utilizing the same steps as previously explained for the submission of Public Input.

For further information on submitting public input and public comments, go to: <http://www.nfpa.org/publicinput>.

Other Resources Available on the Document Information Pages

About tab: View general document and subject-related information.

Current & Prior Editions tab: Research current and previous edition information on a Standard.

Next Edition tab: Follow the committee’s progress in the processing of a Standard in its next revision cycle.

Technical Committee tab: View current committee member rosters or apply to a committee.

Technical Questions tab: For members and Public Sector Officials/AHJs to submit questions about codes and standards to NFPA staff. Our Technical Questions Service provides a convenient way to receive timely and consistent technical assistance when you need to know more about NFPA codes and standards relevant to your work. Responses are provided by NFPA staff on an informal basis.

Products & Training tab: List of NFPA’s publications and training available for purchase.

Information on the NFPA Standards Development Process

I. Applicable Regulations. The primary rules governing the processing of NFPA standards (codes, standards, recommended practices, and guides) are the NFPA *Regulations Governing the Development of NFPA Standards (Regs)*. Other applicable rules include NFPA *Bylaws*, NFPA *Technical Meeting Convention Rules*, NFPA *Guide for the Conduct of Participants in the NFPA Standards Development Process*, and the NFPA *Regulations Governing Petitions to the Board of Directors from Decisions of the Standards Council*. Most of these rules and regulations are contained in the *NFPA Standards Directory*. For copies of the *Directory*, contact Codes and Standards Administration at NFPA Headquarters; all these documents are also available on the NFPA website at “www.nfpa.org.”

The following is general information on the NFPA process. All participants, however, should refer to the actual rules and regulations for a full understanding of this process and for the criteria that govern participation.

II. Technical Committee Report. The Technical Committee Report is defined as “the Report of the responsible Committee(s), in accordance with the Regulations, in preparation of a new or revised NFPA Standard.” The Technical Committee Report is in two parts and consists of the First Draft Report and the Second Draft Report. (See *Regs* at Section 1.4.)

III. Step 1: First Draft Report. The First Draft Report is defined as “Part one of the Technical Committee Report, which documents the Input Stage.” The First Draft Report consists of the First Draft, Public Input, Committee Input, Committee and Correlating Committee Statements, Correlating Notes, and Ballot Statements. (See *Regs* at 4.2.5.2 and Section 4.3.) Any objection to an action in the First Draft Report must be raised through the filing of an appropriate Comment for consideration in the Second Draft Report or the objection will be considered resolved. [See *Regs* at 4.3.1(b).]

IV. Step 2: Second Draft Report. The Second Draft Report is defined as “Part two of the Technical Committee Report, which documents the Comment Stage.” The Second Draft Report consists of the Second Draft, Public Comments with corresponding Committee Actions and Committee Statements, Correlating Notes and their respective Committee Statements, Committee Comments, Correlating Revisions, and Ballot Statements. (See *Regs* at 4.2.5.2 and Section 4.4.) The First Draft Report and the Second Draft Report together constitute the Technical Committee Report. Any outstanding objection following the Second Draft Report must be raised through an appropriate Amending Motion at the NFPA Technical Meeting or the objection will be considered resolved. [See *Regs* at 4.4.1(b).]

V. Step 3a: Action at NFPA Technical Meeting. Following the publication of the Second Draft Report, there is a period during which those wishing to make proper Amending Motions on the Technical Committee Reports must signal their intention by submitting a Notice of Intent to Make a Motion (NITMAM). (See *Regs* at 4.5.2.) Standards that receive notice of proper Amending Motions (Certified Amending Motions) will be presented for action at the annual June NFPA Technical Meeting. At the meeting, the NFPA membership can consider and act on these Certified Amending Motions as well as Follow-up Amending Motions, that is, motions that become necessary as a result of a previous successful Amending Motion. (See 4.5.3.2 through 4.5.3.6 and Table 1, Columns 1-3 of *Regs* for a summary of the available Amending Motions and who may make them.) Any outstanding objection following action at an NFPA Technical Meeting (and any further Technical Committee consideration following successful Amending Motions, see *Regs* at 4.5.3.7 through 4.6.5.3) must be raised through an appeal to the Standards Council or it will be considered to be resolved.

VI. Step 3b: Documents Forwarded Directly to the Council. Where no NITMAM is received and certified in accordance with the Technical Meeting Convention Rules, the standard is forwarded directly to the Standards Council for action on issuance. Objections are deemed to be resolved for these documents. (See *Regs* at 4.5.2.5.)

VII. Step 4a: Council Appeals. Anyone can appeal to the Standards Council concerning procedural or substantive matters related to the development, content, or issuance of any document of the NFPA or on matters within the purview of the authority of the Council, as established by the Bylaws and as determined by the Board of Directors. Such appeals must be in written form and filed with the Secretary of the Standards Council (see *Regs* at Section 1.6). Time constraints for filing an appeal must be in accordance with 1.6.2 of the *Regs*. Objections are deemed to be resolved if not pursued at this level.

VIII. Step 4b: Document Issuance. The Standards Council is the issuer of all documents (see Article 8 of *Bylaws*). The Council acts on the issuance of a document presented for action at an NFPA Technical Meeting within 75 days from the date of the recommendation from the NFPA Technical Meeting, unless this period is extended by the Council (see *Regs* at 4.7.2). For documents forwarded directly to the Standards Council, the Council acts on the issuance of the document at its next scheduled meeting, or at such other meeting as the Council may determine (see *Regs* at 4.5.2.5 and 4.7.4).

IX. Petitions to the Board of Directors. The Standards Council has been delegated the responsibility for the administration of the codes and standards development process and the issuance of documents. However, where extraordinary circumstances requiring the intervention of the Board of Directors exist, the Board of Directors may take any action necessary to fulfill its obligations to preserve the integrity of the codes and standards development process and to protect the interests of the NFPA. The rules for petitioning the Board of Directors can be found in the *Regulations Governing Petitions to the Board of Directors from Decisions of the Standards Council* and in Section 1.7 of the *Regs*.

X. For More Information. The program for the NFPA Technical Meeting (as well as the NFPA website as information becomes available) should be consulted for the date on which each report scheduled for consideration at the meeting will be presented. To view the First Draft Report and Second Draft Report as well as information on NFPA rules and for up-to-date information on schedules and deadlines for processing NFPA documents, check the NFPA website (www.nfpa.org/docinfo) or contact NFPA Codes & Standards Administration at (617) 984-7246.



Xchange™

The place to connect online with your fire, electrical, and life safety peers

Have a question about the code or standard you're reading now?

NFPA Xchange™ can help!

NFPA Xchange™ brings together over 30,000 professionals worldwide, asking and answering each other's questions, sharing ideas, and discussing the issues impacting your industry today.

NFPA Xchange™ is free to join and offers:

- A robust collection of previously asked and answered questions to search
- Access to thousands of peers for problem-solving and on-the-job advice
- NFPA blogs, white papers, and webinars in one convenient place

NFPA members also enjoy Xchange™ **Members Only**, the online space for technical questions* answered by NFPA staff, exclusive NFPA live events, and premier access to curated content.

Join NFPA Xchange™ TODAY!

www.nfpa.org/xchange

Xchange Today. Safer Tomorrow.

*For the full terms of use, please visit nfpa.org/standard_items/terms-of-use#xchange. NFPA® is a registered trademark of the National Fire Protection Association, Quincy, MA 02169.