



The Safety Association for Canada's
Upstream Oil and Gas Industry

Process Safety vs. Personal Safety

Compiled by: Andy Reimer, Program Manager, Enform

Process Safety

- Has come to the forefront of oil and gas industry concerns as a result of statements like this:
 - *BP management paid attention to, measured, and rewarded **personal safety** rather than **process safety**.*

(Safety Board report on Texas City refinery explosion, as repeated in President's Report on BP Deepwater Horizon Oil Spill and Offshore Drilling, 221)
 - *...To understand how this operated we must first make the distinction between **occupational safety**, sometimes called **personal safety**, on the one hand, and **process safety** on the other.*

(A. Hopkins, "Management Walk-Arounds: Lessons from the Gulf of Mexico Oil Well Blowout" [February 2011], 9)

Explaining It...(in 10 seconds)

If you're in charge of safety and you think of hazards like this...



You're probably doing "personal safety"

Explaining It...(in 10 seconds)

If you're in charge of safety and you think of hazards like this...

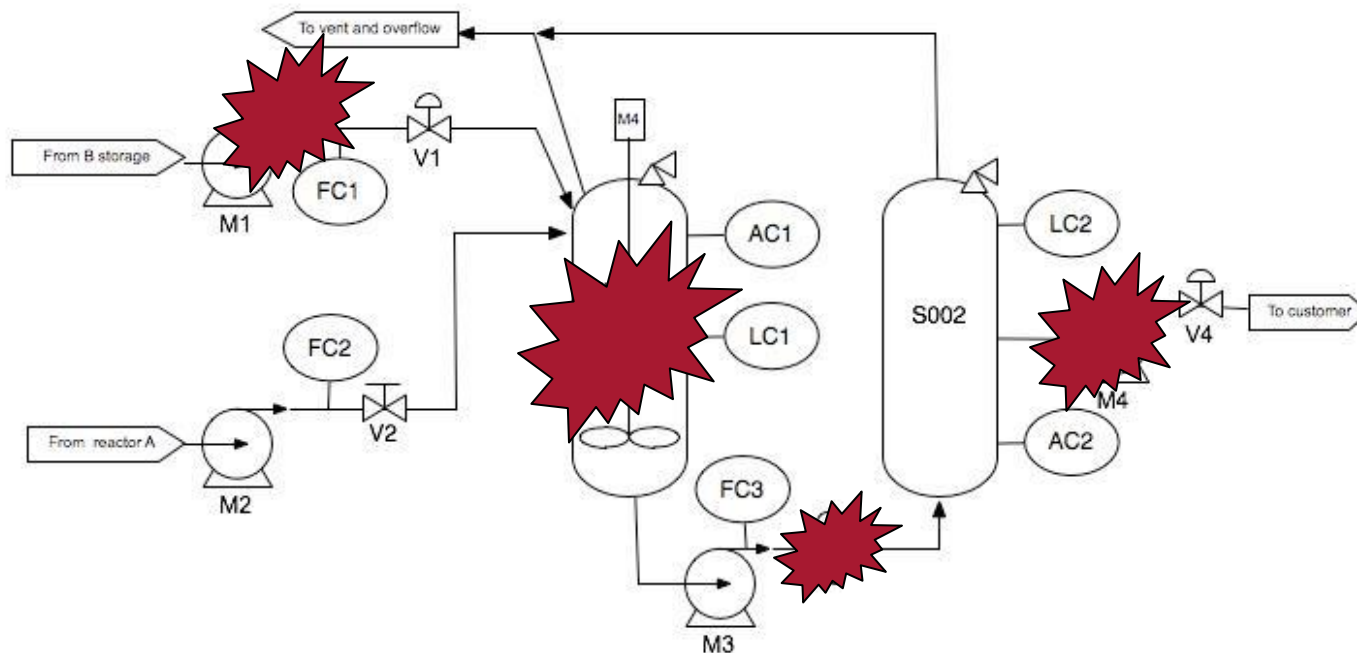

You're probably doing "process safety"

Personal vs Process Safety

- The classic distinction:

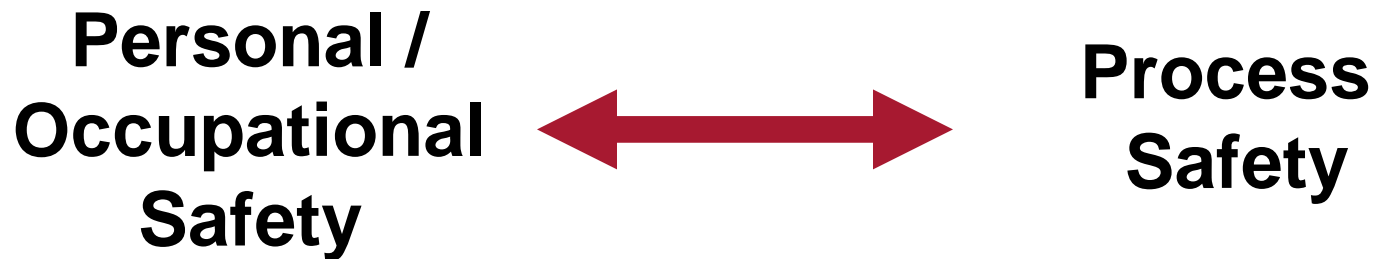

- In nearly every introduction to process safety, this distinction will be made as a way to define the domain of process safety

Typical Contrasting Definitions

- *...not distinguished between occupational safety—concern over **slips, strains, and other workplace accidents**—and process safety: **hazard analysis, design for safety, material verification, equipment maintenance, and process-change reporting**.*
(President's Report on BP Deepwater Horizon Oil Spill and Offshore Drilling, 221)
- *This corresponds to a distinction between conventional safety risks, that result in relatively high frequency, low consequence events (e.g., **slips, trips, and falls**) and major hazard risks, that give rise to low frequency high consequence events (e.g., **explosions**).*
(A. Hopkins, "Management Walk-Arounds: Lessons from the Gulf of Mexico Oil Well Blowout" [February 2011], 9)

Process Safety Defined, e.g.'s

- *The protection of people and property from episodic and catastrophic incidents that may result from unplanned or unexpected deviations in process conditions.*

(Guidelines for Auditing Process Safety Management Systems, 2nd ed. [New York: Center for Chemical Process Safety, 2011], xxvi)

- *Process Safety is a blend of engineering and management skills focused on preventing catastrophic accidents, particularly explosions, fires, and toxic releases, associated with the use of chemicals and petroleum products.*

(Murray Macza, "A Canadian Perspective of the History of Process Safety Management Legislation" [Cologne, Germany, 2008], 12/2)

Process Safety Defined, e.g.'s

- *Process safety is a blend of engineering and management skills focused on preventing catastrophic accidents and near misses, particularly structural collapse, explosions, fires and toxic releases associated with loss of containment of energy or dangerous substances such as chemicals and petroleum products. These engineering and management skills exceed those required for managing workplace safety.*
(Energy Institute's expansion of CCPS definition
[www.energyinst.org/technical/safety/process-safety])

Defining by Contrast

- In the remaining presentation, process safety will be illustrated through a series of simplified contrasts with personal (aka occupational) safety
- The goal is a quick understanding of the interests of process safety, not a nuanced definition for each
- While readily contrasted—this ***does not necessarily mean*** they must be managed or addressed in distinct or separated siloes!

Applicable

Personal Safety

- ...to all workplace scenarios, any industry

Process Safety

- ...primarily to process industries, e.g.,
 - Chemical
 - Petrochemical
 - Energy/Utility

(Any industry dealing with materials with intrinsically hazardous properties and subject to major accident hazard)

Some Associated Terms

Personal Safety

Slips, Trips, & Falls

On Site Hazard ID

Incident Reporting

JHA

Tailgate Safety Meeting

PPE

Unsafe Acts, Unsafe Conditions

Process Safety

Design for Safety

PHA

HAZOP

Asset Integrity

Human Factors

Material Verification

ALARP

Management of Change

Intrinsically Safe

LOPA

Equipment Maintenance

Process-Change Reporting

Major Hazard / Major Accident Hazard

Focus of Concern

Personal Safety

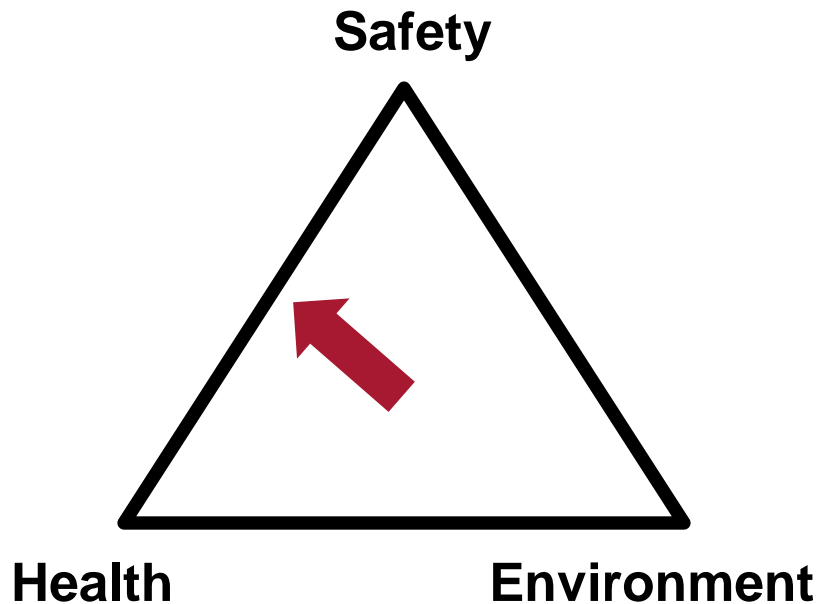

Process Safety

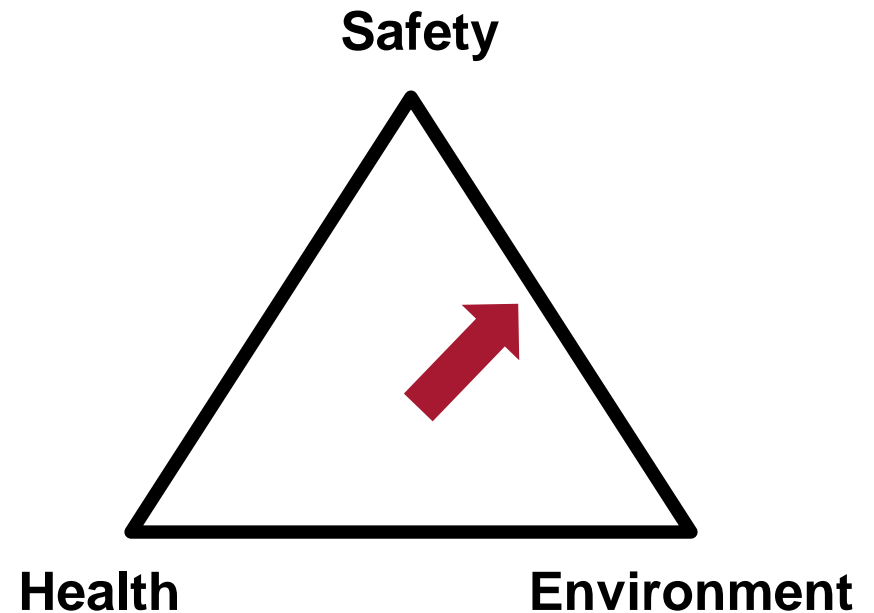

“Risk Matrix” Profile

Personal Safety

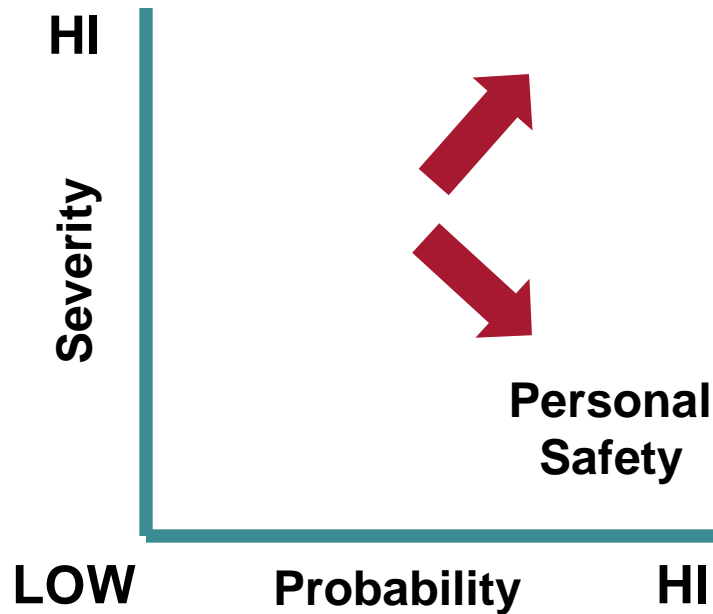

Process Safety

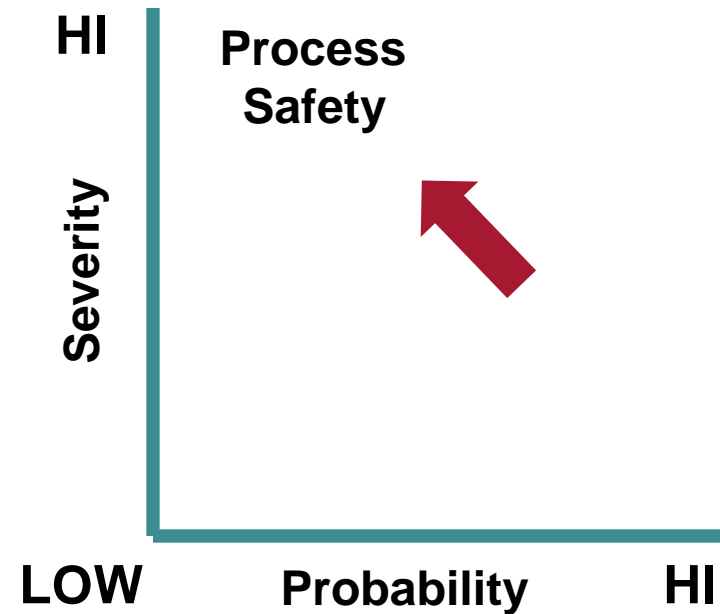

Outcome

Personal Safety

- Prevention of a series of incidents

Incident A 

Incident B 

Incident C 

Incident D 

Process Safety

- Prevention of the catastrophic incident

Incident A 

“Safety Pyramid”

Personal Safety

Typically good visibility into numerous incidents at bottom of pyramid to drive system improvements

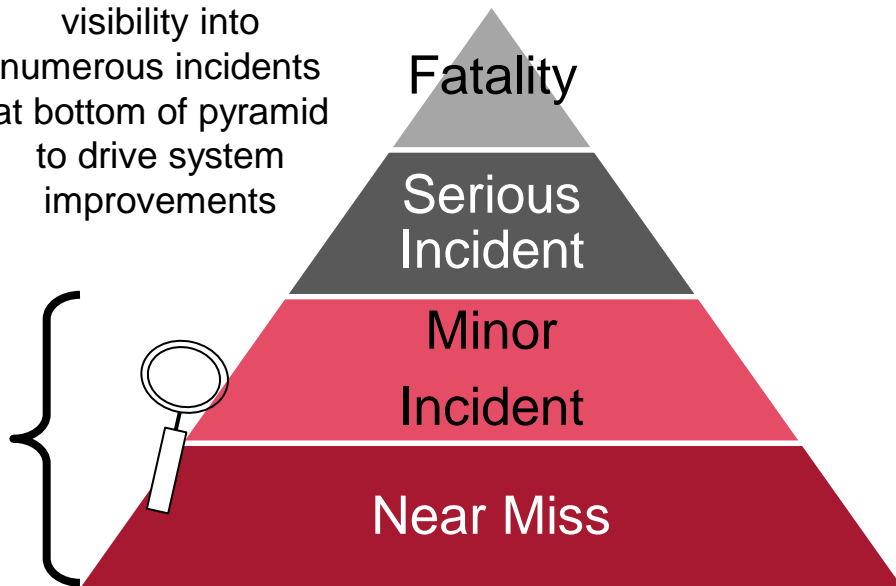

Process Safety

Bottom of pyramid is less visible and more complex to measure. Serious incidents have defined process safety evolution.

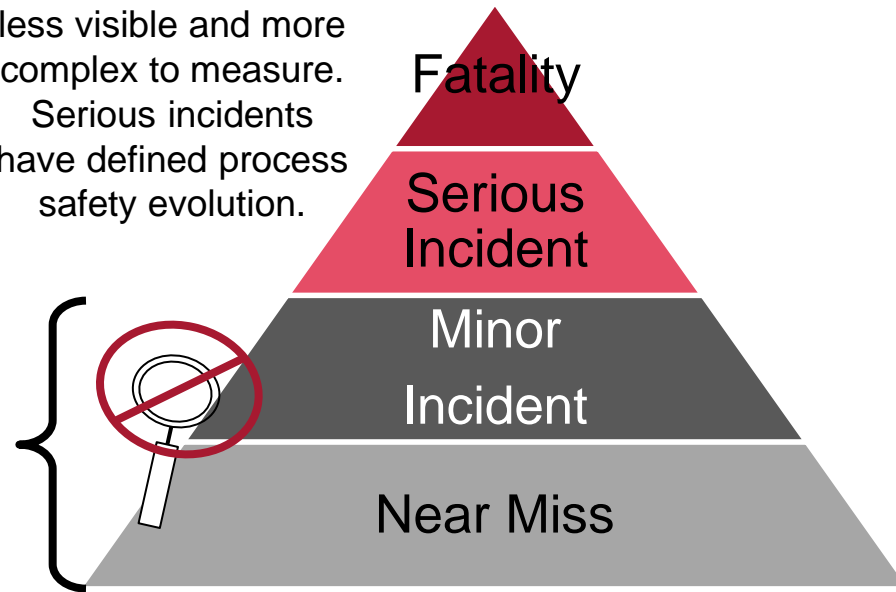

Metrics

Personal Safety

- “WCB Stats”, e.g.,
 - TRIF (Total Recordable Incident Frequency)
 - Lost-Time Claim Rate
 - Disabling Injury Rate
- Established metrics
- Both leading and lagging indicators

Process Safety

- “Process Safety Metrics”, e.g.,
 - Process Safety Total Incident Rate
 - Process Safety Incident Severity Rate
- Metrics subject to debate, difficult to measure
- Both leading and lagging indicators

Hazard ID & Assessment

Personal Safety

- Lends itself to a wide range of participants
- May be conducted in some cases with minimal training
- Often managed entirely in-house

Process Safety

- Requires technical & often engineering expertise in processes and materials handled
- Frequently facilitated by external consultants

Hazard Control

Personal Safety

Process Safety

Hierarchy of Control

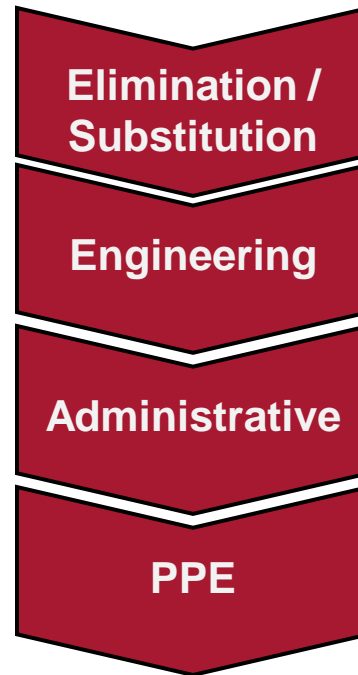

Should start here... →

But frequently lands here... ↘

*As such, responsibility for hazard controls is often in hands of **front line workers** and **supervisors***

← Must start here

*As such, responsibility for hazard controls is often in hands of **senior management** and **engineers***

Safety Culture

Personal Safety

- Must especially be nurtured with:
 - Field & Shop Managers
 - Supervisors
 - Front Line Supervisors
 - Workers

(Note: Personal safety hazard controls are typically managed within existing operational budgets)

Process Safety

- Must especially be nurtured with:
 - Senior Executives
 - Senior Management
 - Any Key Decision-Makers

(Note: Process safety hazard assessments and controls often carry a price tag that requires senior operational buy-in)

Goal

Personal Safety

- To protect personnel from injury and illness...
- But outcomes include equipment & operational integrity and lower incident costs

Process Safety

- To protect capital assets and environment...
- But outcomes include safety of personnel

Goal

Personal Safety

- To protect personnel from injury and illness...
- But outcomes include equipment & operational integrity and lower incident costs

Process Safety

- To protect capital assets and environment...

- But outcomes include safety of personnel

The personal injury / human loss potential on process safety incidents are typically high compared to personal safety incidents

Outcome

Personal Safety

- Prevention of a series of incidents

Incident A 

Incident B 

Incident C 

Incident D 

Process Safety

- » Prevention of the catastrophic incident

Incident A 

Management System

Personal Safety*

- Element A: Management Involvement and Commitment
- Element B: Hazard Identification and Assessment
(includes Inspections and Site Specific Hazard ID and Reporting)
- Element C: Hazard Control
(includes Preventive Maintenance and Hazardous Materials)
- Element D: Training
- Element E: Emergency Response
- Element F: Incident Reporting and Investigations
- Element G: Communication
(includes Safety Records and Audit)
- Element H: Joint Health and Safety Committee

**Example from Enform COR Audit Protocol*

Process Safety**

Process safety leadership

1. Leadership commitment & responsibility
2. Identification & compliance with legislation & industry standards
3. Employee selection, placement, competency & health assurance
4. Workforce involvement
5. Communication with stakeholders

Risk identification & assessment

6. Hazard identification & risk assessment
7. Documentation, records & knowledge management

Risk management

8. Operating manuals & procedures
9. Process & operational status monitoring & handover
10. Management of operational interfaces
11. Standards & practices
12. Management of change & project management
13. Operational readiness & process start-up
14. Emergency preparedness
15. Inspection & maintenance
16. Management of safety critical devices
17. Work control, permit-to-work & test risk management
18. Contractor & supplier, selection & management

Review & improvement

19. Incident reporting & investigation
20. Audit, assurance, management review & intervention

***Example from Energy Institute PSM Framework,
<http://www.energyinst.org/technical/psm/PSM-framework>*

Managed Independently?

- Does an emphasis on personal safety ***necessarily*** lead to inattention to process safety?
- Are personal safety and process safety contradictory or complementary?
- Considerable overlap in approach and management system elements.
 - Can a company build out elements of their PSM system from their existing H&SMS?
 - Does the introduction of PSM elements raise the standard for a company's H&SMS?



The Safety Association for Canada's
Upstream Oil and Gas Industry

Thank You
