

Work At Heights Toolkit

for Supervisors



For Supervisors



How to use this toolkit?



The toolkit aims to provide information for supervisor to communicate one topic a day to workers.



Pictures are for illustration purposes only.



Green box or a green tick shows the correct practice.



Red box or a red cross shows the wrong practice.



**SAFE USE OF PERSONAL FALL
ARREST SYSTEM (PFAS)**

Get a buddy to check if you are wearing your harness correctly.

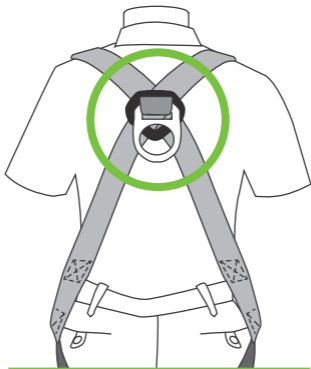

The D-ring should be located between shoulder blades.

Ensure that the D-ring on your harness faces the same side as the anchor point.

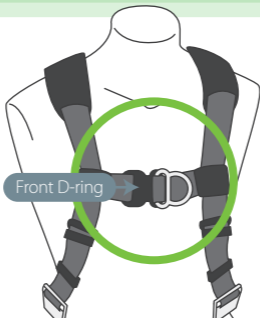

When using your rear D-ring, the anchor point should be behind you.



If the anchor point is in front of you, ensure that your harness has a front D-ring for you to use.

Ensure that anchor point is secured before starting work.

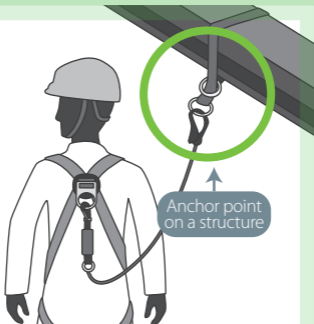

The anchor point should be secured on structure that has been assessed as safe for use.



Do not start work if the anchor point is not secure.

Ensure that your body harness is the correct fit.

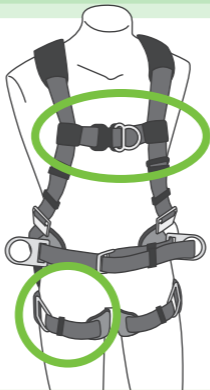

Tighten chest and leg straps so that no more than two fingers can fit between strap and body.

Ensure that your lanyard is anchored at all times.

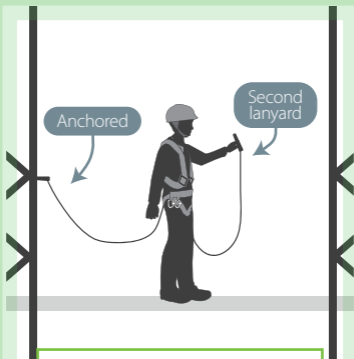

While being anchored, move to the next anchor point with your second lanyard.



Always maintain 100% tie-off.

Ensure that your lanyard is hooked onto an anchor point at all times.

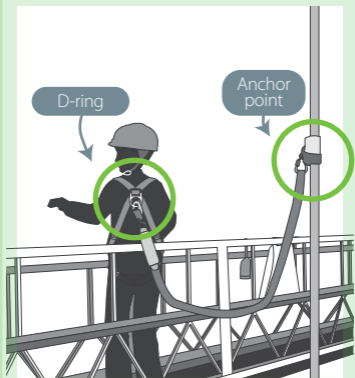

The lanyard should be hooked on the D-ring of your harness and the anchor point.

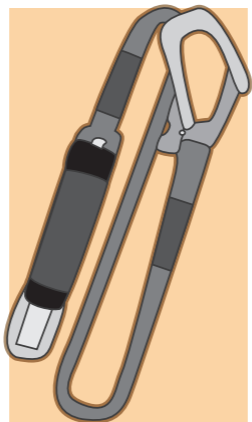

**INSPECTION OF PERSONAL
FALL ARREST SYSTEM (PFAS)**

Check that the surface of your harness webbing is not damaged.



Hold the webbing with both hands and bend it into an inverted "U" shape to check for damage.



Do **not** use the harness if the webbing is damaged.

Inspect your harness before every use.

Loosened stitching

Frayed edges

Cuts



Inform your supervisor if your harness is loose, worn out or cut.



Do **not** use the harness if the webbing, D-ring or any parts are damaged.

Ensure that the connector is not damaged.



Check that the locking gear is not stuck.



Do **not** use the connector if any part is damaged.

Inspect the energy absorber of your lanyard and look out for damaged surface.

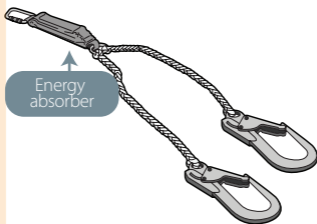

Look out for holes, cuts or tears on the outer protective layer of the energy absorber.



Do **not** use the lanyard if the energy absorber has been activated before.

Check that your equipment has the manufacturer's label.

CONTENT OF HARNESS IDENTITY LABEL

<u>trade mark of the device</u>		<u>number/year of the European standards</u>	EN 361-2002 EN 358 -2000
<u>type of the device</u>	SAFETY HARNESS	<u>the equipment</u>	
<u>reference number</u>	Ref AB 152 01	<u>month/year of the device manufacture</u>	Date of manufacture : 03/2003
<u>size</u>	Size: M-XL	<u>number of the manufacturing series</u>	
<u>CE marking and number of</u>	CE 0082	<u>caution read the manual</u>	
		<u>marking of the manufacturer or distributor</u>	Serial number: 0000001

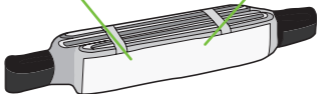

Check the expiry date of your equipment. Ask your supervisor if you are not sure.



Inform your supervisor if your equipment has expired.

Do not make any markings on your harness as it may damage the harness.

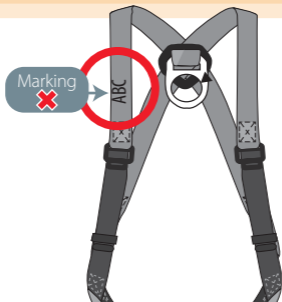

Harness must not have any markings, burn marks, cuts or cracks.



Inform your supervisor if there are any markings on the harness.



**Danger
Fragile Roof**

**WORKING ON OR NEAR
FRAGILE SURFACES**

Fragile Surfaces

1

Report any fragile surfaces in your work area to your supervisor.



A fragile surface is one that may **not** support your weight.

Examples include: roof skylight, rusted metal sheets, glass and plastic roof panels that cover an opening which you can fall through.

Do not enter an area with fragile surfaces unless you are authorised.



Do **not** enter if you are not trained or do not understand how to work safely on or around fragile surfaces.



Do **not** enter if you were not briefed on the locations and hazards of fragile surfaces in your work area.

Ensure that you are protected before stepping on a fragile surface.

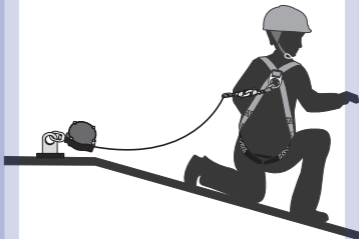

Always follow the safety control measures before you enter an area with fragile surfaces.



Check with your supervisor if you are unsure if a surface is fragile.

Keep work area tidy to prevent tripping and falling on a fragile surface.

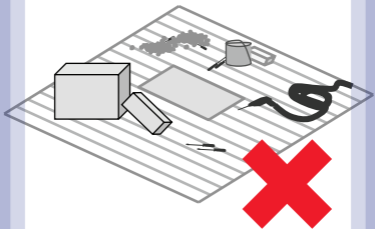

Do **not** place items or tools that may obstruct your walkways and work area.

If you trip and fall on a fragile surface, the sudden and high force may break the surface.

Avoid working alone on or near fragile surfaces.

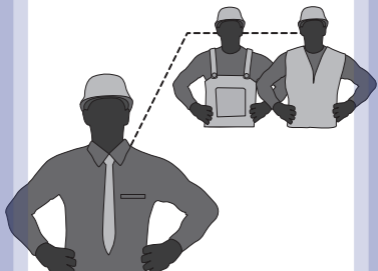

Always work with a buddy and check on each other's proper use of safety control measures.



Stay within your buddy's view and keep in contact with your supervisor.

**Do not place tools
and materials on
fragile surfaces.**

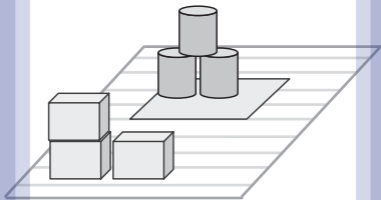

Discuss with your supervisor on how to safely load tools and materials onto your work area.

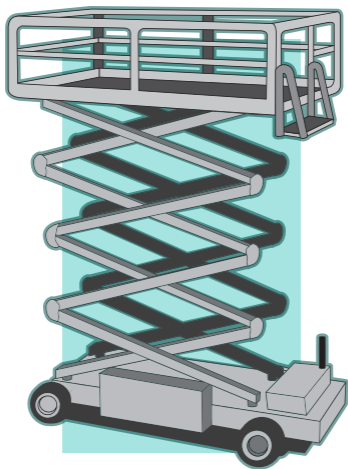

**SAFE USE OF MOBILE
ELEVATING WORK
PLATFORM (MEWP)**

Only operate an MEWP if you are trained and authorised.



When working on a MEWP, always follow instructions from the authorised operator.



Only use the MEWP for the task your supervisor asked you to do.

Do not use the MEWP if it is not suitable for the job.



Do **not** use the MEWP if it is not high enough to reach your work area.



Do **not** use the MEWP if the ground is too soft, uneven or slippery.

Keep both feet on the work platform at all times.

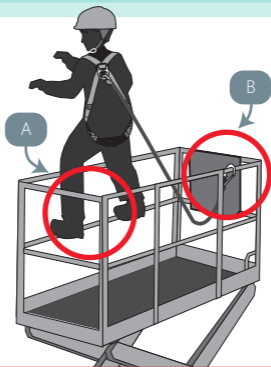

 A. Do **not** climb onto guardrails.

 B. Do **not** anchor your lanyard to the guardrail.

Connect your lanyard to a certified anchor point inside the MEWP.

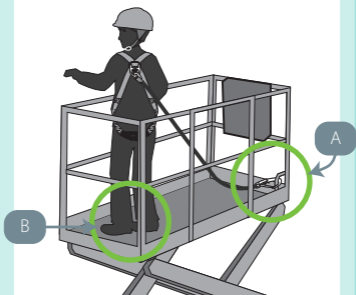

A: Connect onto proper anchor point, and not to guardrails.



B: Stand on the platform and do not climb on guardrails even when connected.

Do not turn off any safety devices of the MEWP.

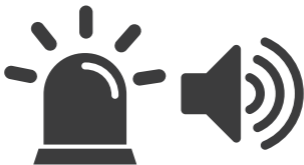

Pay attention to any safety alarm when operating and working on your MEWP.



Do **not** use the MEWP if any of the safety devices doesn't work.

Protect your MEWP from other moving vehicles in the area.



Inform your supervisor if there are any moving equipment (e.g., crane) near your work area.



Implement control measures (e.g., set up barricade).

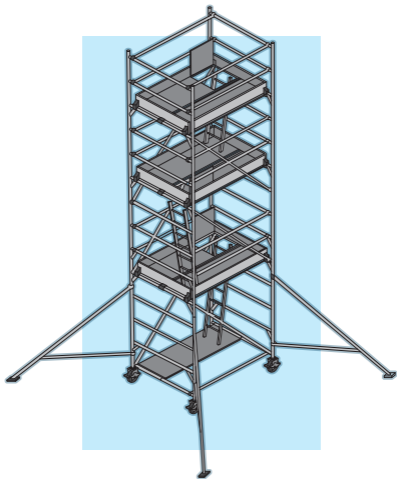

**SAFE USE OF
SCAFFOLDS**

Check that scaffold is "Safe for Use" before using.

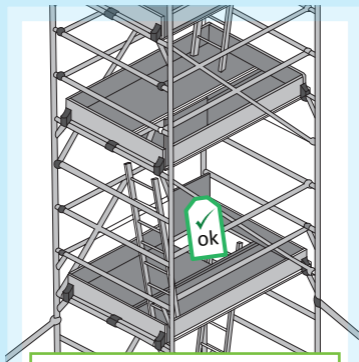



Look for the "Safe for Use" tag at the scaffold's access point.

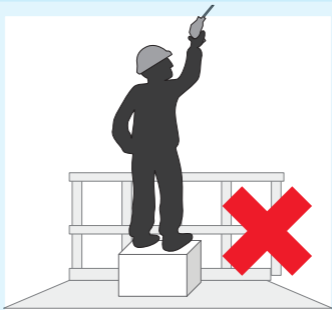

Report to your supervisor if you do not see the "Safe for Use" tag.

Do not stand on objects to gain height on a work platform.



 Do **not** climb onto guardrails.

 Do **not** stand on items placed on the work platform. The guardrails will not be effective to prevent you from falling.

Do not overload the scaffold.

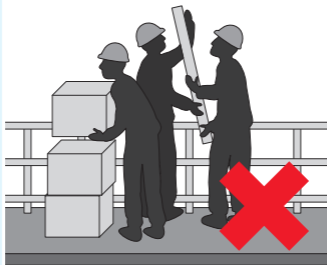

Do **not** carry unauthorised tools and materials to prevent overloading the scaffold.



Do **not** crowd on a work platform. Stay within your own work area.

Check that a work platform is safe before stepping on it.



There should be no openings except for the access ladder.



Work platforms should be at least 50 cm wide with no big gaps between.

Do not move a mobile tower scaffold when anyone is on it.



Do **not** access or work on a mobile scaffold until all wheels are locked.

Do not change or remove any part of a scaffold.



Do **not** add or remove any parts of the scaffold.



Inform your supervisor if you are unable to reach your work area.

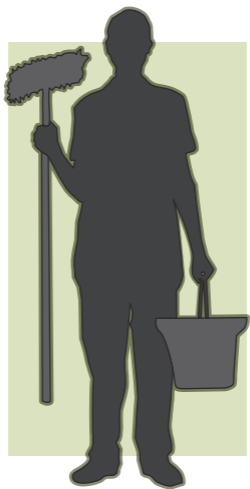

HOUSEKEEPING

Select the correct tools before working at heights.



Replace the tool if it is damaged.



Only bring the tools that are necessary for the task.

Arrange and secure your tools and materials.



Secure hand tools to your body (e.g., using a tool belt) before working at heights.



Place the tools and materials at areas designated by your supervisor.

Organise all objects at the elevated platform properly.

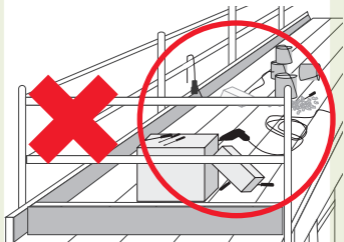

Tie up all cords, hoses and ropes to prevent tripping.



Do **not** leave tools, materials and debris all over the work platform.

Do not place items at walkways and access points.



Clear walkway



Keep walkways and access points clear at all times.



Be aware of your emergency evacuation route and check that it is not blocked.

Check that your work area has adequate lighting.

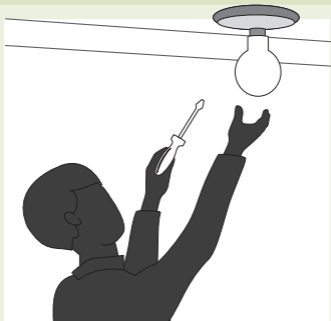

Lighting should be bright enough for you to work safely.



Clean lighting fixtures regularly. Replace lights that are dim or faulty.

Keep your work area clean to prevent any hazards.

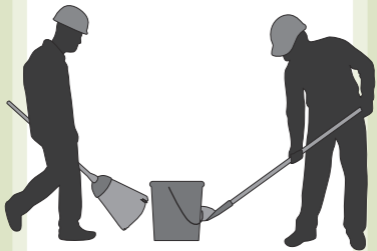

Clean up your work area after your shift.



Do **not** leave items that may cause slips or trips on the work platform.

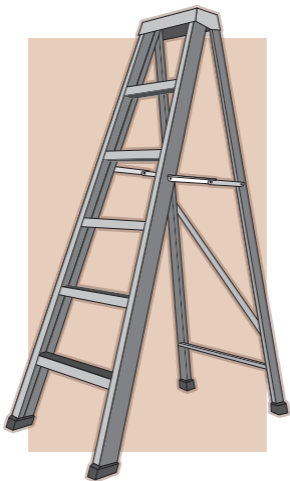

**SAFE USE
OF LADDERS**

Check that the ladder is safe before using.

Spreader not extended fully

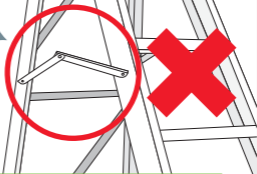

Ensure all spreaders are able to extend fully.



Always check that the ladder is not damaged before using.

Ensure that the ladder is stable before using.

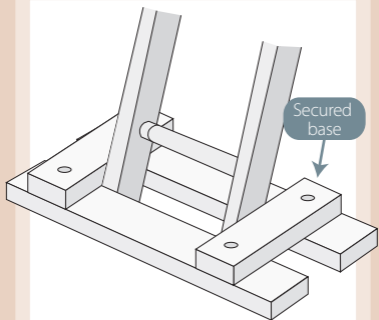

- ✓ Base of the ladder should be secured.
- ✓ Place the ladder on stable and level ground.

Do not stand on the top rung of a ladder.



The ladder's height must be suitable so that you do not overstretch.

Always maintain 3-point contact.

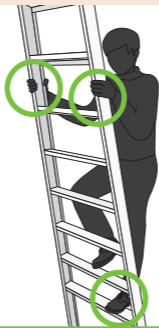

3-point contact refers to using two hands and one leg or one hand and two legs on the ladder.



Do **not** lean away from the ladder.

Use a suitable ladder to carry out the work.



Choose a ladder that is suitable for the job.



Do **not** use items such as chairs or boxes to replace a ladder.

Set up the ladder at a safe place.



Do **not** set up ladders in passageways, doorways or near the edge of an open floor or on scaffolding.

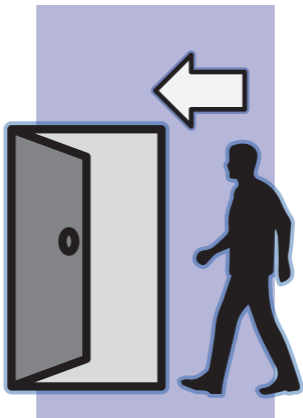

ACCESS AND EGRESS

Keep access and egress points clear at all times.



Check that the access and egress area is well-maintained and not blocked.

Know the access and egress points for your work area.



Always be aware of your access and egress routes.



Follow the directions to exit during emergencies.

Clean up any slips hazards along your access route.



For spills on a small area, use proper equipment to clean up.



Check with your supervisor if you are unsure what the spilled chemical is.



For big spills, inform your supervisor and get help to clean up.

Do not access a restricted area if you are not authorised to enter.



Do **not** enter a restricted area you are not assigned to work in. There may be hazards that you are not aware of.

For ladder access to another level, check that it extends 1 metre above the landing point.

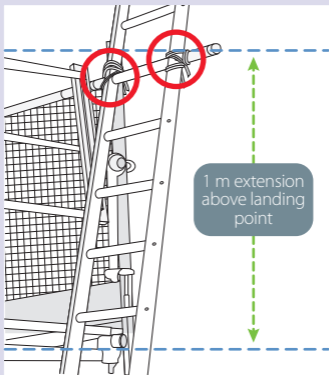

The ladder extension above the landing point provides a secure handhold.

**Keep your hands free
when climbing.**

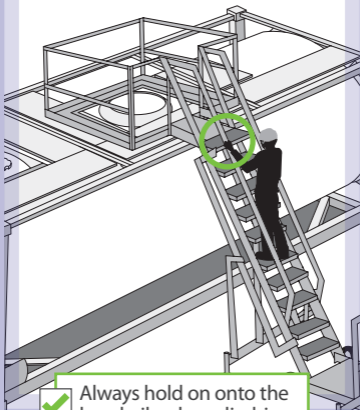

Always hold on onto the handrails when climbing.

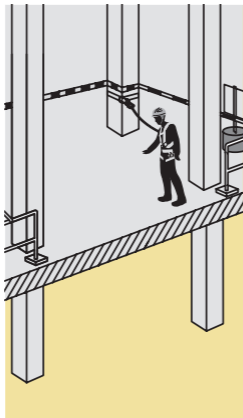

**WORKING NEAR
OPEN SIDES**

Understand the control measures if you are working near an open side.

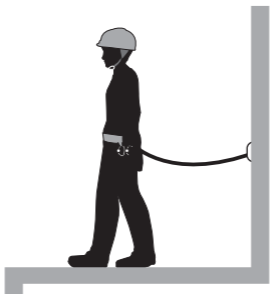

You must be trained on how to work safely near an open side, for example, using travel restraint properly.

Do not use an unprotected stairway to access your work area.

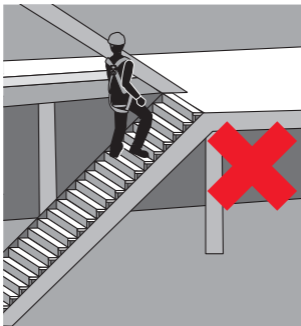

Report any unprotected stairways to your supervisor. All stairways should be protected with handrails.

Report any unguarded openings to your supervisor.

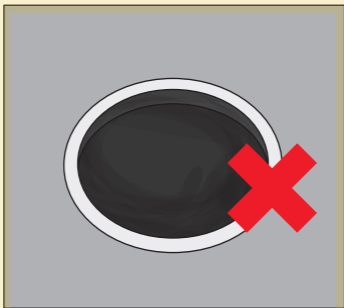

Openings should be securely fenced or covered to prevent falling hazard.



Openings should be guarded at all times, even during breaks.

Working Near Open Sides

4

Do not remove any guardrails unless instructed by your supervisor.



Always follow all safety control measures when removing any guardrails.

Do not move a cover for an opening as you will create a falling hazard.

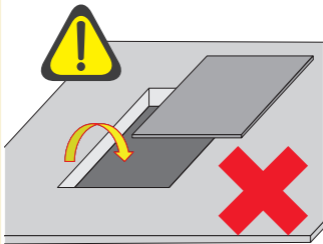

Covers for openings should be secure and not easily removed.

Ensure that the guardrails and covers are in good condition before you start work.

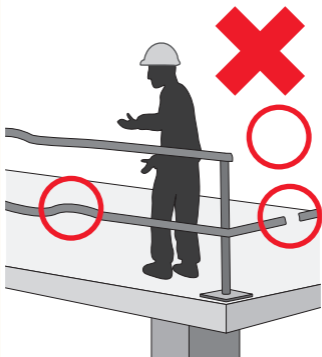

Inform your supervisor immediately if you see any missing, incomplete or damaged guard rails or covers.

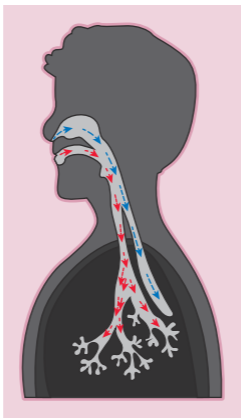

**WORKPLACE
HEALTH**

Do not work at heights if you are feeling unwell.



Inform your supervisor if you are not feeling well or have to take medicine that will cause drowsiness.

Take regular breaks and drink enough water when working under the sun.



Limit exposure to direct sunlight where possible.



Rest under shade during your break time.

Wear ear protection when working in noisy areas.

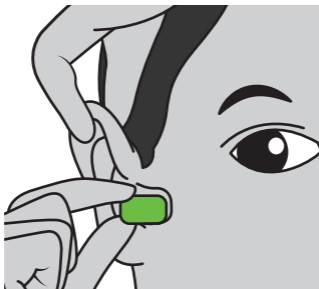

Insert ear plugs properly.

Maintain correct posture when performing your work.

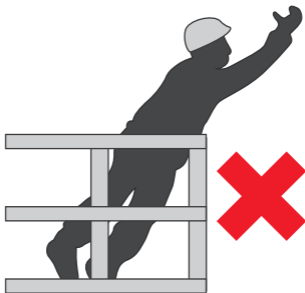

Take regular breaks when possible to relax your muscles.



Do **not** work in over-stretched position.

Wear the correct PPE when handling hazardous chemicals.



Before using the chemicals, know their hazards and safety measures.



Wearing the correct PPE will help prevent contact with harmful chemicals.

Keep your back straight
and bend your knees
when you lift items.



Do **not** lift with your back
as it may cause back injury.



All rights reserved. This publication may not be reproduced or transmitted in any form or by any means, in whole or in part, without prior written permission from the Workplace Safety and Health (WSH) Council. The information provided in this publication is accurate as at time of printing. The learning points and recommendations are not exhaustive and should neither be taken to encapsulate all the responsibilities imposed by law nor as replacement for independent legal advice. The WSH Council does not accept any liability or responsibility to any party for any losses or damage arising from the use of this publication.

Published in March 2016 by the
Workplace Safety and Health
Council in Collaboration with
the Ministry of Manpower

Website: www.wshc.sg
Email: contact@wshc.sg

